

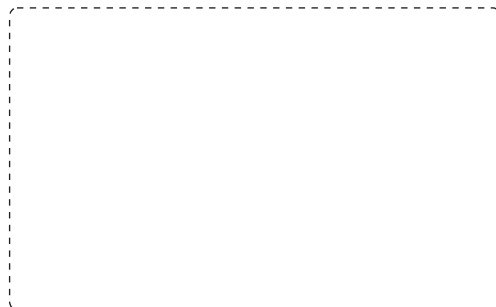

Chint Electrics, S.L.

Calle C, num.38 - Pol.Ind.1
28938-MOSTOLES (Madrid)
Tel.: +34-91.645.03.53
Fax: +34-91.645.95.82
e-mail: info@chintelectrics.es
website: www.chint.com



© CHINT. Nº. ES B15
Enero 2011 (2ª Edición)



Material de Baja Tensión

Verde • La electricidad • El futuro

- La electricidad es un motor de civilización.
- El verde es el aspecto original del mundo.

CHINT

- Promueve la tecnología de energías renovables.
- Promueve la ideología verde.
- Amplia el futuro de la electricidad mediante su avanzada tecnología.

CHINT

- Se dedica a la fabricación de equipos eléctricos desde hace más de 20 años para ofrecer permanentemente a sus clientes las más avanzadas soluciones en sistemas eléctricos de Baja Tensión.

Desplegamos todas las posibilidades de la electricidad.



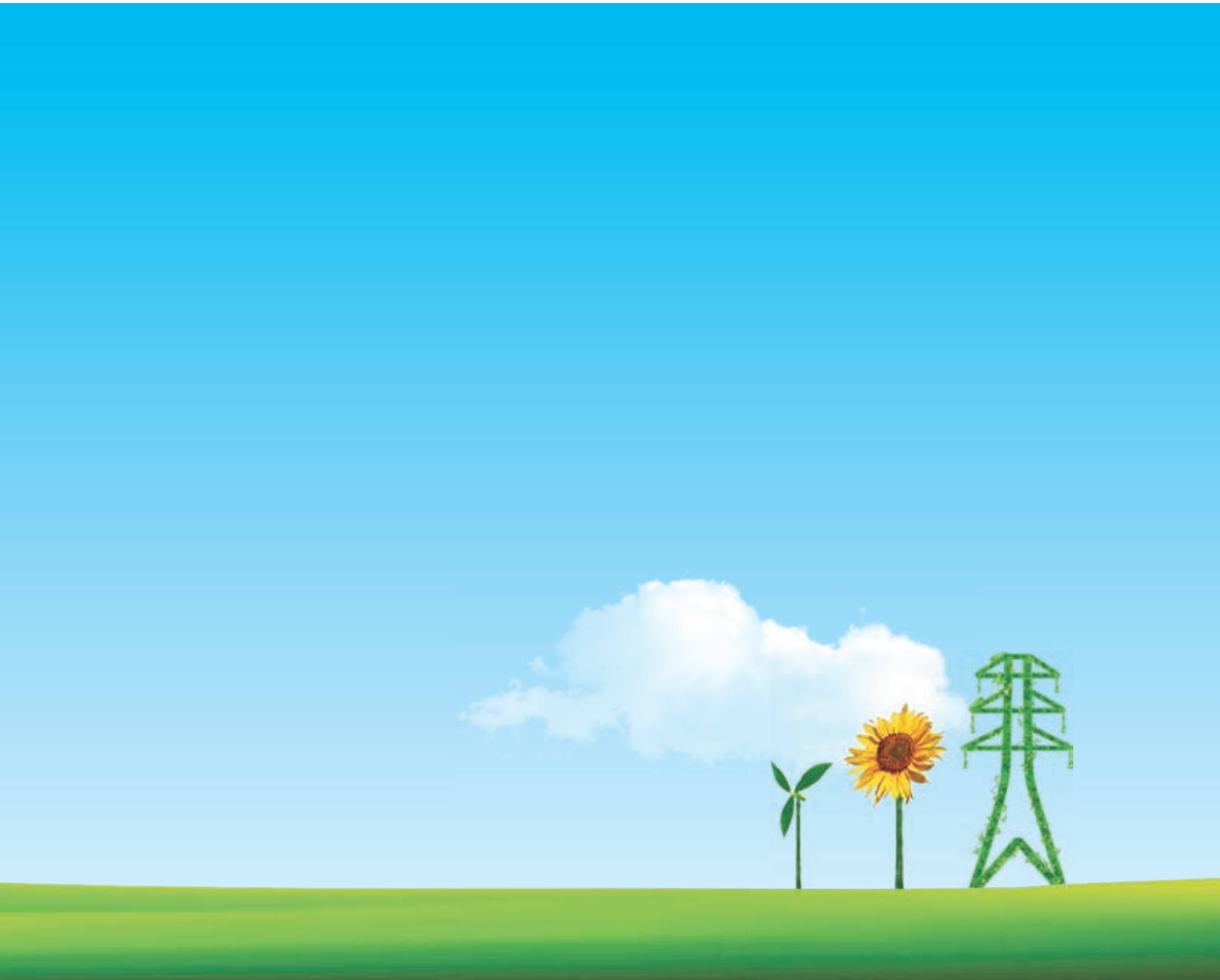

CHNT





CHINA+ TOMORROW= CHINT

“CHIN” de China, “T” de Tomorrow, ... la China del mañana



CHINT se dedica a la fabricación de equipos eléctricos desde hace más de 20 años, perfeccionando los sistemas eléctricos y electrónicos así como su control de calidad, eficiencia, etc.

Fabricamos más de 120 series de productos con un total de 10.000 referencias, pensando siempre en el ahorro energético y en el medioambiente.

Proveemos a nuestros clientes con soluciones integrales en los campos de la mecánica, construcción, comunicaciones, climatización, metalurgia, petróleo, ferroviario, etc.



Mediante nuestro sistema de ventas podemos proveer a nuestros clientes de un servicio totalmente profesionalizado, y de calidad, en todo el mundo.



En estos tiempos en los cuales la globalización es el elemento dominante, CHINT insiste en desarrollar un plan, a nivel internacional, de renovación constante en los aspectos tecnológico, productivo y administrativo.

Proveemos a nuestros clientes de tecnología y de un servicio funcional, cuidando especialmente el coste de nuestros productos para ser un proveedor que esté en condiciones de ayudarle, resolviendo todos los problemas que se presenten en sus proyectos.



Equipamientos eléctricos de CHINT



CHINT ha pasado, en pocos años, de ser un fabricante de aparatos eléctricos al por menor a ser un fabricante de soluciones para sistemas eléctricos. Con el poder que le ha dado su total dedicación a la industria CHINT ha gozado de una enorme transformación, produciendo productos y servicios estables, seguros y más económicos, comprometiéndose en la mejora del medio ambiente con el fin de ofrecer a sus clientes productos de 1ª calidad. CHINT ha estudiado las necesidades tecnológicas especiales de cada sector: mecánica, construcción, comunicaciones, climatización, metalurgia, petróleo, ferrocarriles, etc. para ofrecer las mejores soluciones en proyectos de equipamientos eléctricos. El compromiso de CHINT en Europa, América, Asia y África se concentra en la renovación tecnológica y en la creación de un futuro verde.

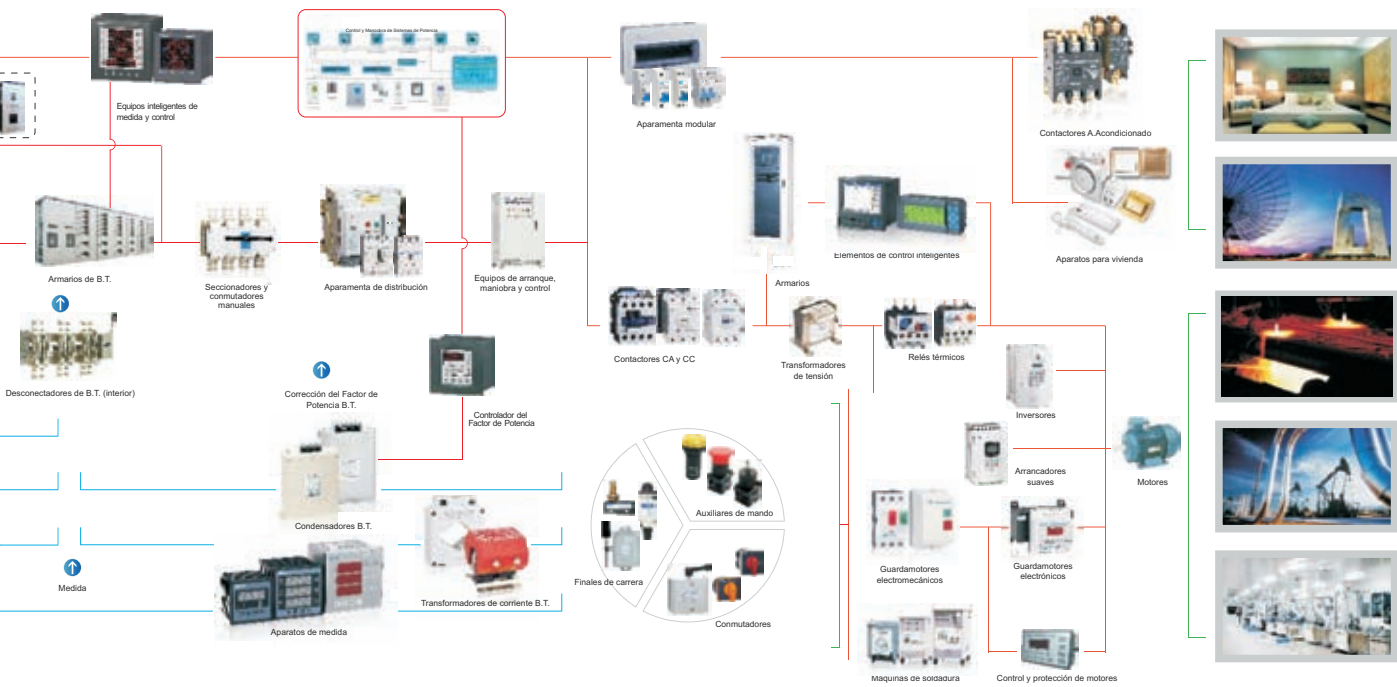

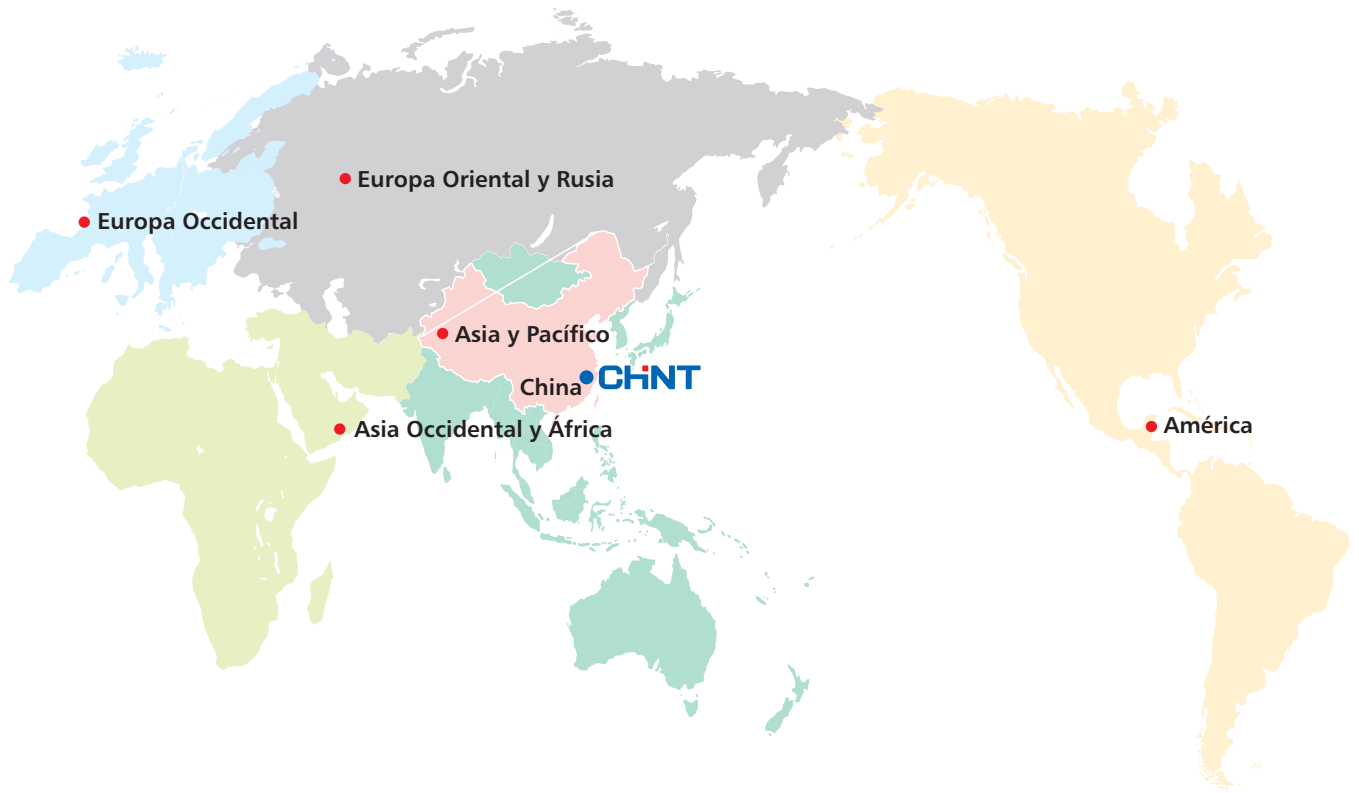

Europa Occidental



América



Europa Oriental y Rusia



Asia Occidental y África



Asia y Pacífico



TARIFA DE PRECIOS - ENERO 2011

	Aparamenta modular	1
	Interruptores en Caja Moldeada	31
	Interruptores de Corte al Aire	43
	Protección diferencial industrial	47
	Aparatos de medida analógicos y digitales	48
	Contactores, Relés Térmicos, Guardamotores	49
	Maniobras con contactores	57
	Auxliares de Mando y Señalización - Diam.22mm	61
	Auxliares de Mando y Señalización - Diam.16mm	75
	Botoneras colgantes	78
	Fusibles cilíndricos y tipo NH	79
	Relés y Bases	81
	Condensadores de B.T.	83
	Transformadores de tensión	86
	Transformadores de intensidad	87
	Seccionadores y Conmutadores	93
	Contadores de Energía y de Prepago	99
	Finales de Carrera, Microrruptores, Pedales	100
	Cuadros metálicos para instalación	101
	Cuadros metálicos para aparamenta modular	104
	Armarios metálicos	114
€	Índice de referencias y precios por orden alfabético	125
	Condiciones Generales de Venta	153

eB

Interruptores automáticos

SECTOR DOMÉSTICO

CE	N	S	SAA
U.E	España	Suecia	Australia

Polos	2P
Intensidad Nominal	6,10,16,20,25,32,40A
Poder de corte	6kA (6.000A)
Curvas	C
Norma	UNE-EN 60898-1



F1	Referencia	Polos	Intensidad nominal (A)	Curva	Embalaje	P.V.P.
	eB-2-6C	2P	6	C	6/72	7,70€
	eB-2-10C	2P	10	C	6/72	7,70€
	eB-2-16C	2P	16	C	6/72	7,70€
	eB-2-20C	2P	20	C	6/72	7,70€
	eB-2-25C	2P	25	C	6/72	7,70€
	eB-2-32C	2P	32	C	6/72	8,50€
	eB-2-40C	2P	40	C	6/72	8,60€

DZ267

Interruptores automáticos

SECTOR DOMÉSTICO

CE		PG
U.E	Ucrania	Rusia

Polos	1P+N (1 módulo 18mm)
Intensidad Nominal	6,10,16,20,25,32A
Poder de corte	4,5kA (4.500A)
Curvas	C
Norma	UNE-EN 60898-1



F1	Referencia	Polos	Intensidad nominal (A)	Curva	Embalaje	P.V.P.
	DZ267-1N-6C	1P+N	6	C	12/120	10,02€
	DZ267-1N-10C	1P+N	10	C	12/120	10,02€
	DZ267-1N-16C	1P+N	16	C	12/120	10,02€
	DZ267-1N-20C	1P+N	20	C	12/120	10,02€
	DZ267-1N-25C	1P+N	25	C	12/120	10,02€
	DZ267-1N-32C	1P+N	32	C	12/120	10,02€

NBH8

Interruptores automáticos

SECTOR TERCIARIO

CE		S		PG	RCC
U.E	Alemania	Suecia	Ucrania	Rusia	Sudáfrica

Polos	1P+N (1 módulo 18mm)
Intensidad Nominal	6,10,16,20,25,32,40A
Poder de corte	6kA (6.000A)
Curvas	C
Norma	UNE-EN 60898-1



F1	Referencia	Polos	Intensidad nominal (A)	Curva	Embalaje	P.V.P.
	NBH8-1N-6C	2P	6	C	12/120	24,60€
	NBH8-1N-10C	2P	10	C	12/120	24,60€
	NBH8-1N-16C	2P	16	C	12/120	24,60€
	NBH8-1N-20C	2P	20	C	12/120	24,60€
	NBH8-1N-25C	2P	25	C	12/120	24,60€
	NBH8-1N-32C	2P	32	C	12/120	26,10€
	NBH8-1N-40C	2P	40	C	12/120	26,10€

UB Interruptores automáticos SECTOR TERCIARIO

CE	S	UOS	SAA
U.E	Suecia	Ucrania	Australia

Polos	1,2,3,4P
Intensidad Nominal	6, 10, 16, 20, 25, 32, 40A
Poder de corte	6kA (6.000A)
Curvas	C
Norma	UNE-EN 60898-1



F1	Referencia	Polos	Intensidad nominal (A)	Curva	Embalaje	P.V.P.
	UB-1-6C	1P	6	C	12/120	9,80€
	UB-1-10C	1P	10	C	12/120	9,80€
	UB-1-16C	1P	16	C	12/120	9,80€
	UB-1-20C	1P	20	C	12/120	9,80€
	UB-1-25C	1P	25	C	12/120	9,80€
	UB-1-32C	1P	32	C	12/120	10,10€
	UB-1-40C	1P	40	C	12/120	11,80€



F1	Referencia	Polos	Intensidad nominal (A)	Curva	Embalaje	P.V.P.
	UB-2-6C	2P	6	C	6/60	21,60€
	UB-2-10C	2P	10	C	6/60	21,60€
	UB-2-16C	2P	16	C	6/60	21,60€
	UB-2-20C	2P	20	C	6/60	21,60€
	UB-2-25C	2P	25	C	6/60	21,60€
	UB-2-32C	2P	32	C	6/60	23,90€
	UB-2-40C	2P	40	C	6/60	28,00€



F1	Referencia	Polos	Intensidad nominal (A)	Curva	Embalaje	P.V.P.
	UB-3-6C	3P	6	C	4/40	34,20€
	UB-3-10C	3P	10	C	4/40	34,20€
	UB-3-16C	3P	16	C	4/40	34,20€
	UB-3-20C	3P	20	C	4/40	34,20€
	UB-3-25C	3P	25	C	4/40	34,20€
	UB-3-32C	3P	32	C	4/40	37,20€
	UB-3-40C	3P	40	C	4/40	46,10€



F1	Referencia	Polos	Intensidad nominal (A)	Curva	Embalaje	P.V.P.
	UB-4-6C	4P	6	C	3/30	45,40€
	UB-4-10C	4P	10	C	3/30	45,40€
	UB-4-16C	4P	16	C	3/30	45,40€
	UB-4-20C	4P	20	C	3/30	45,40€
	UB-4-25C	4P	25	C	3/30	45,40€
	UB-4-32C	4P	32	C	3/30	48,50€
	UB-4-40C	4P	40	C	3/30	63,40€

NB1-ICP
Interruptores automáticos
SECTOR DOMÉSTICO



Polos	1,2,3,4P
Intensidad Nominal	3,3.5,5,10,15,20,25,30,40,45,50,63A
Poder de corte	6kA (6.000A)
Curvas	ICP
Norma	UNE-20317 (ICP)

Aprobación: CM/AU/02-08 - BOE: 13/11/2008



F1	Referencia	Polos	Intensidad nominal (A)	Embalaje	Curva	P.V.P.
	NB1-ICP-1-3	1P	3	12/180	ICP	33,50€
	NB1-ICP-1-3.5	1P	3.5	12/180	ICP	33,50€
	NB1-ICP-1-5	1P	5	12/180	ICP	18,50€
	NB1-ICP-1-10	1P	10	12/180	ICP	14,10€
	NB1-ICP-1-15	1P	15	12/180	ICP	14,20€
	NB1-ICP-1-20	1P	20	12/180	ICP	14,60€
	NB1-ICP-1-25	1P	25	12/180	ICP	14,80€
	NB1-ICP-1-30	1P	30	12/180	ICP	19,20€
	NB1-ICP-1-35	1P	35	12/180	ICP	22,10€
	NB1-ICP-1-40	1P	40	12/180	ICP	24,90€
	NB1-ICP-1-45	1P	45	12/180	ICP	26,50€
	NB1-ICP-1-50	1P	50	12/180	ICP	47,10€
	NB1-ICP-1-63	1P	63	12/180	ICP	49,90€



F1	Referencia	Polos	Intensidad nominal (A)	Embalaje	Curva	P.V.P.
	NB1-ICP-2-3	2P	3	6/90	ICP	60,30€
	NB1-ICP-2-3.5	2P	3.5	6/90	ICP	60,30€
	NB1-ICP-2-5	2P	5	6/90	ICP	38,60€
	NB1-ICP-2-10	2P	10	6/90	ICP	22,30€
	NB1-ICP-2-15	2P	15	6/90	ICP	22,80€
	NB1-ICP-2-20	2P	20	6/90	ICP	23,60€
	NB1-ICP-2-25	2P	25	6/90	ICP	25,20€
	NB1-ICP-2-30	2P	30	6/90	ICP	39,10€
	NB1-ICP-2-35	2P	35	6/90	ICP	47,50€
	NB1-ICP-2-40	2P	40	6/90	ICP	48,00€
	NB1-ICP-2-45	2P	45	6/90	ICP	58,70€
	NB1-ICP-2-50	2P	50	6/90	ICP	78,20€
	NB1-ICP-2-63	2P	63	6/90	ICP	96,00€



F1	Referencia	Polos	Intensidad nominal (A)	Embalaje	Curva	P.V.P.
	NB1-ICP-3-3	3P	3	4/60	ICP	100,20€
	NB1-ICP-3-3.5	3P	3.5	4/60	ICP	100,20€
	NB1-ICP-3-5	3P	5	4/60	ICP	58,10€
	NB1-ICP-3-10	3P	10	4/60	ICP	53,00€
	NB1-ICP-3-15	3P	15	4/60	ICP	53,40€
	NB1-ICP-3-20	3P	20	4/60	ICP	54,80€
	NB1-ICP-3-25	3P	25	4/60	ICP	56,10€
	NB1-ICP-3-30	3P	30	4/60	ICP	60,40€
	NB1-ICP-3-35	3P	35	4/60	ICP	75,50€
	NB1-ICP-3-40	3P	40	4/60	ICP	78,20€
	NB1-ICP-3-45	3P	45	4/60	ICP	80,70€
	NB1-ICP-3-50	3P	50	4/60	ICP	128,30€
	NB1-ICP-3-63	3P	63	4/60	ICP	145,30€



F1	Referencia	Polos	Intensidad nominal (A)	Embalaje	Curva	P.V.P.
	NB1-ICP-4-3	4P	3	3/45	ICP	150,30€
	NB1-ICP-4-3.5	4P	3.5	3/45	ICP	150,30€
	NB1-ICP-4-5	4P	5	3/45	ICP	83,80€
	NB1-ICP-4-10	4P	10	3/45	ICP	80,80€
	NB1-ICP-4-15	4P	15	3/45	ICP	81,00€
	NB1-ICP-4-20	4P	20	3/45	ICP	81,50€
	NB1-ICP-4-25	4P	25	3/45	ICP	83,50€
	NB1-ICP-4-30	4P	30	3/45	ICP	88,10€
	NB1-ICP-4-35	4P	35	3/45	ICP	103,30€
	NB1-ICP-4-40	4P	40	3/45	ICP	106,30€
	NB1-ICP-4-45	4P	45	3/45	ICP	122,30€
	NB1-ICP-4-50	4P	50	3/45	ICP	177,30€
	NB1-ICP-4-63	4P	63	3/45	ICP	183,30€

NB1
Interruptores automáticos
SECTOR INDUSTRIAL

Polos	1,2,3,4P
Intensidad Nominal	1,2,3,4,6,10,16,20,25,32,40,50,63A
Poder de corte	6kA (6.000A)
Curvas	B, C, D
Norma	UNE-60898-1 y UL1077

CE	UL	IEC	VDE	S	FI	CCC	SNI	005	PG	RCC	UL	UL LISTED	SP
U. E	Noruega	Reino Unido	Alemania	Suecia	Finlandia	Chequia	Indonesia	Ucrania	Rusia	Sudáfrica	Sri Lanka	EE.UU.	Canadá



In (A)	Embalaje	Referencias y P.V.P.					
		Curva B F3		Curva C F1		Curva D F3	
		Referencia	P.V.P.	Referencia	P.V.P.	Referencia	P.V.P.
1	12/180	NB1-1-1B	15,50€	NB1-1-1C	14,80€	NB1-1-1D	21,20€
2	12/180	NB1-1-2B	15,50€	NB1-1-2C	14,80€	NB1-1-2D	21,20€
3	12/180	NB1-1-3B	15,50€	NB1-1-3C	14,80€	NB1-1-3D	21,20€
4	12/180	NB1-1-4B	15,50€	NB1-1-4C	14,80€	NB1-1-4D	21,20€
6	12/180	NB1-1-6B	14,00€	NB1-1-6C	13,70€	NB1-1-6D	17,70€
10	12/180	NB1-1-10B	14,00€	NB1-1-10C	13,70€	NB1-1-10D	17,70€
16	12/180	NB1-1-16B	14,00€	NB1-1-16C	13,70€	NB1-1-16D	17,70€
20	12/180	NB1-1-20B	14,00€	NB1-1-20C	13,70€	NB1-1-20D	17,70€
25	12/180	NB1-1-25B	14,00€	NB1-1-25C	13,70€	NB1-1-25D	17,70€
32	12/180	NB1-1-32B	14,00€	NB1-1-32C	14,00€	NB1-1-32D	17,70€
40	12/180	NB1-1-40B	20,80€	NB1-1-40C	15,30€	NB1-1-40D	21,40€
50	12/180	NB1-1-50B	30,60€	NB1-1-50C	28,20€	NB1-1-50D	33,20€
63	12/180	NB1-1-63B	36,20€	NB1-1-63C	31,30€	NB1-1-63D	40,10€



In (A)	Embalaje	Referencias y P.V.P.					
		Curva B F3		Curva C F1		Curva D F3	
		Referencia	P.V.P.	Referencia	P.V.P.	Referencia	P.V.P.
1	6/90	NB1-2-1B	31,20€	NB1-2-1C	30,20€	NB1-2-1D	44,80€
2	6/90	NB1-2-2B	31,20€	NB1-2-2C	30,20€	NB1-2-2D	44,80€
3	6/90	NB1-2-3B	31,20€	NB1-2-3C	30,20€	NB1-2-3D	44,80€
4	6/90	NB1-2-4B	31,20€	NB1-2-4C	30,20€	NB1-2-4D	44,80€
6	6/90	NB1-2-6B	29,40€	NB1-2-6C	27,80€	NB1-2-6D	36,40€
10	6/90	NB1-2-10B	29,40€	NB1-2-10C	27,80€	NB1-2-10D	36,40€
16	6/90	NB1-2-16B	29,40€	NB1-2-16C	27,80€	NB1-2-16D	36,40€
20	6/90	NB1-2-20B	29,40€	NB1-2-20C	27,80€	NB1-2-20D	36,40€
25	6/90	NB1-2-25B	29,40€	NB1-2-25C	27,80€	NB1-2-25D	36,40€
32	6/90	NB1-2-32B	29,40€	NB1-2-32C	28,20€	NB1-2-32D	36,40€
40	6/90	NB1-2-40B	37,90€	NB1-2-40C	36,10€	NB1-2-40D	48,40€
50	6/90	NB1-2-50B	54,40€	NB1-2-50C	48,20€	NB1-2-50D	59,50€
63	6/90	NB1-2-63B	70,00€	NB1-2-63C	59,90€	NB1-2-63D	76,80€



In (A)	Embalaje	Referencias y P.V.P.					
		Curva B F3		Curva C F1		Curva D F3	
		Referencia	P.V.P.	Referencia	P.V.P.	Referencia	P.V.P.
1	4/60	NB1-3-1B	74,10€	NB1-3-1C	70,70€	NB1-3-1D	76,10€
2	4/60	NB1-3-2B	74,10€	NB1-3-2C	70,70€	NB1-3-2D	76,10€
3	4/60	NB1-3-3B	74,10€	NB1-3-3C	70,70€	NB1-3-3D	76,10€
4	4/60	NB1-3-4B	74,10€	NB1-3-4C	70,70€	NB1-3-4D	76,10€
6	4/60	NB1-3-6B	48,50€	NB1-3-6C	44,40€	NB1-3-6D	55,40€
10	4/60	NB1-3-10B	48,50€	NB1-3-10C	44,40€	NB1-3-10D	55,40€
16	4/60	NB1-3-16B	48,50€	NB1-3-16C	44,40€	NB1-3-16D	55,40€
20	4/60	NB1-3-20B	48,50€	NB1-3-20C	44,40€	NB1-3-20D	55,40€
25	4/60	NB1-3-25B	48,50€	NB1-3-25C	44,40€	NB1-3-25D	55,40€
32	4/60	NB1-3-32B	48,50€	NB1-3-32C	44,40€	NB1-3-32D	55,40€
40	4/60	NB1-3-40B	62,60€	NB1-3-40C	59,90€	NB1-3-40D	71,40€
50	4/60	NB1-3-50B	82,50€	NB1-3-50C	80,10€	NB1-3-50D	93,60€
63	4/60	NB1-3-63B	111,90€	NB1-3-63C	104,80€	NB1-3-63D	129,80€



In (A)	Embalaje	Referencias y P.V.P.					
		Curva B F3		Curva C F1		Curva D F3	
		Referencia	P.V.P.	Referencia	P.V.P.	Referencia	P.V.P.
1	3/45	NB1-4-1B	81,60€	NB1-4-1C	77,80€	NB1-4-1D	95,30€
2	3/45	NB1-4-2B	81,60€	NB1-4-2C	77,80€	NB1-4-2D	95,30€
3	3/45	NB1-4-3B	81,60€	NB1-4-3C	77,80€	NB1-4-3D	95,30€
4	3/45	NB1-4-4B	81,60€	NB1-4-4C	77,80€	NB1-4-4D	95,30€
6	3/45	NB1-4-6B	65,00€	NB1-4-6C	58,90€	NB1-4-6D	74,10€
10	3/45	NB1-4-10B	65,00€	NB1-4-10C	58,90€	NB1-4-10D	74,10€
16	3/45	NB1-4-16B	65,00€	NB1-4-16C	58,90€	NB1-4-16D	74,10€
20	3/45	NB1-4-20B	65,00€	NB1-4-20C	58,90€	NB1-4-20D	74,10€
25	3/45	NB1-4-25B	65,00€	NB1-4-25C	58,90€	NB1-4-25D	74,10€
32	3/45	NB1-4-32B	65,00€	NB1-4-32C	58,90€	NB1-4-32D	74,10€
40	3/45	NB1-4-40B	83,70€	NB1-4-40C	82,80€	NB1-4-40D	95,40€
50	3/45	NB1-4-50B	125,80€	NB1-4-50C	116,50€	NB1-4-50D	143,50€
63	3/45	NB1-4-63B	142,50€	NB1-4-63C	129,50€	NB1-4-63D	165,90€

NB1
Interruptores automáticos
SECTOR INDUSTRIAL

Polos	1,2,3,4P
Intensidad Nominal	1,2,3,4,6,10,16,20,25,32,40,50,63A
Poder de corte	10kA (10.000A) 1 a 32A= 15kA (según UNE-EN60947-2)
Curvas	B, C, D
Norma	UNE-EN60898-1

U.E	Noruega	Reino Unido	Suecia	Chequia	Indonesia	Ucrania	Rusia

Características en corriente continua

- * Los interruptores NB1 de 10kA de poder de corte, curvas B y C, de 1P, trabajan a 240Vca y a 125Vcc indistintamente.
- * Los interruptores NB1 de 10kA de poder de corte, curvas B y C, de 2P trabajan a 415Vca y a 250Vcc indistintamente



In (A)	Embalaje	Referencias y P.V.P.					
		Curva B		Curva C		Curva D	
		Referencia	P.V.P.	Referencia	P.V.P.	Referencia	P.V.P.
1	12/180	NB1-1-1B10	27,40€	NB1-1-1C10	26,10€	NB1-1-1D10	29,20€
2	12/180	NB1-1-2B10	27,40€	NB1-1-2C10	26,10€	NB1-1-2D10	29,20€
3	12/180	NB1-1-3B10	27,40€	NB1-1-3C10	26,10€	NB1-1-3D10	29,20€
4	12/180	NB1-1-4B10	27,40€	NB1-1-4C10	26,10€	NB1-1-4D10	29,20€
6	12/180	NB1-1-6B10	19,20€	NB1-1-6C10	18,00€	NB1-1-6D10	20,80€
10	12/180	NB1-1-10B10	19,20€	NB1-1-10C10	18,00€	NB1-1-10D10	20,80€
16	12/180	NB1-1-16B10	19,20€	NB1-1-16C10	18,00€	NB1-1-16D10	20,80€
20	12/180	NB1-1-20B10	19,20€	NB1-1-20C10	18,00€	NB1-1-20D10	20,80€
25	12/180	NB1-1-25B10	19,20€	NB1-1-25C10	18,00€	NB1-1-25D10	20,80€
32	12/180	NB1-1-32B10	19,20€	NB1-1-32C10	18,00€	NB1-1-32D10	20,80€
40	12/180	NB1-1-40B10	23,90€	NB1-1-40C10	22,90€	NB1-1-40D10	25,80€
50	12/180	NB1-1-50B10	36,50€	NB1-1-50C10	34,70€	NB1-1-50D10	39,20€
63	12/180	NB1-1-63B10	45,90€	NB1-1-63C10	42,90€	NB1-1-63D10	47,60€



In (A)	Embalaje	Referencias y P.V.P.					
		Curva B		Curva C		Curva D	
		Referencia	P.V.P.	Referencia	P.V.P.	Referencia	P.V.P.
1	6/90	NB1-2-1B10	44,70€	NB1-2-1C10	42,30€	NB1-2-1D10	49,70€
2	6/90	NB1-2-2B10	44,70€	NB1-2-2C10	42,30€	NB1-2-2D10	49,70€
3	6/90	NB1-2-3B10	44,70€	NB1-2-3C10	42,30€	NB1-2-3D10	49,70€
4	6/90	NB1-2-4B10	44,70€	NB1-2-4C10	42,30€	NB1-2-4D10	49,70€
6	6/90	NB1-2-6B10	37,70€	NB1-2-6C10	36,50€	NB1-2-6D10	38,50€
10	6/90	NB1-2-10B10	37,70€	NB1-2-10C10	36,50€	NB1-2-10D10	38,50€
16	6/90	NB1-2-16B10	37,70€	NB1-2-16C10	36,50€	NB1-2-16D10	38,50€
20	6/90	NB1-2-20B10	37,70€	NB1-2-20C10	36,50€	NB1-2-20D10	38,50€
25	6/90	NB1-2-25B10	37,70€	NB1-2-25C10	36,50€	NB1-2-25D10	38,50€
32	6/90	NB1-2-32B10	37,70€	NB1-2-32C10	36,50€	NB1-2-32D10	38,50€
40	6/90	NB1-2-40B10	48,40€	NB1-2-40C10	47,60€	NB1-2-40D10	49,40€
50	6/90	NB1-2-50B10	52,00€	NB1-2-50C10	49,70€	NB1-2-50D10	83,40€
63	6/90	NB1-2-63B10	69,70€	NB1-2-63C10	62,70€	NB1-2-63D10	86,20€



In (A)	Embalaje	Referencias y P.V.P.					
		Curva B		Curva C		Curva D	
		Referencia	P.V.P.	Referencia	P.V.P.	Referencia	P.V.P.
1	4/60	NB1-3-1B10	83,40€	NB1-3-1C10	73,40€	NB1-3-1D10	89,40€
2	4/60	NB1-3-2B10	83,40€	NB1-3-2C10	73,40€	NB1-3-2D10	89,40€
3	4/60	NB1-3-3B10	83,40€	NB1-3-3C10	73,40€	NB1-3-3D10	89,40€
4	4/60	NB1-3-4B10	83,40€	NB1-3-4C10	73,40€	NB1-3-4D10	89,40€
6	4/60	NB1-3-6B10	57,70€	NB1-3-6C10	55,50€	NB1-3-6D10	57,70€
10	4/60	NB1-3-10B10	57,70€	NB1-3-10C10	55,50€	NB1-3-10D10	57,70€
16	4/60	NB1-3-16B10	57,70€	NB1-3-16C10	55,50€	NB1-3-16D10	57,70€
20	4/60	NB1-3-20B10	57,70€	NB1-3-20C10	55,50€	NB1-3-20D10	57,70€
25	4/60	NB1-3-25B10	57,70€	NB1-3-25C10	55,50€	NB1-3-25D10	57,70€
32	4/60	NB1-3-32B10	57,70€	NB1-3-32C10	55,50€	NB1-3-32D10	57,70€
40	4/60	NB1-3-40B10	82,10€	NB1-3-40C10	71,70€	NB1-3-40D10	89,40€
50	4/60	NB1-3-50B10	110,50€	NB1-3-50C10	100,00€	NB1-3-50D10	116,60€
63	4/60	NB1-3-63B10	130,40€	NB1-3-63C10	117,30€	NB1-3-63D10	148,00€



In (A)	Embalaje	Referencias y P.V.P.					
		Curva B		Curva C		Curva D	
		Referencia	P.V.P.	Referencia	P.V.P.	Referencia	P.V.P.
1	3/45	NB1-4-1B10	110,00€	NB1-4-1C10	104,30€	NB1-4-1D10	111,80€
2	3/45	NB1-4-2B10	110,00€	NB1-4-2C10	104,30€	NB1-4-2D10	111,80€
3	3/45	NB1-4-3B10	110,00€	NB1-4-3C10	104,30€	NB1-4-3D10	111,80€
4	3/45	NB1-4-4B10	110,00€	NB1-4-4C10	104,30€	NB1-4-4D10	111,80€
6	3/45	NB1-4-6B10	74,10€	NB1-4-6C10	73,70€	NB1-4-6D10	76,50€
10	3/45	NB1-4-10B10	74,10€	NB1-4-10C10	73,70€	NB1-4-10D10	76,50€
16	3/45	NB1-4-16B10	74,10€	NB1-4-16C10	73,70€	NB1-4-16D10	76,50€
20	3/45	NB1-4-20B10	74,10€	NB1-4-20C10	73,70€	NB1-4-20D10	76,50€
25	3/45	NB1-4-25B10	74,10€	NB1-4-25C10	73,70€	NB1-4-25D10	76,50€
32	3/45	NB1-4-32B10	74,10€	NB1-4-32C10	73,70€	NB1-4-32D10	76,50€
40	3/45	NB1-4-40B10	103,40€	NB1-4-40C10	95,30€	NB1-4-40D10	112,80€
50	3/45	NB1-4-50B10	138,80€	NB1-4-50C10	127,30€	NB1-4-50D10	147,40€
63	3/45	NB1-4-63B10	155,30€	NB1-4-63C10	142,30€	NB1-4-63D10	177,20€

NB1-CC

Interruptores automáticos para corriente continua

SECTOR INDUSTRIAL



Polos	1,2P
Intensidad Nomina	1,2,3,4,6,10,16,20,25,32,40,50,63A
Poder de corte	10kA (10.000A)
Curvas	4~7xIn y 7~15xIn
Norma	UL1077

APARATOS UNIPOLARES > Tensión de Utilización: 110Vcc



In (A)	Embalaje	Polos	Referencias y P.V.P.			
			Curva 4~7xIn F2		Curva 7~15xIn F2	
			Referencia	P.V.P.	Referencia	P.V.P.
1	12/180	1	NB1-1-1CC47	30,80€	NB1-1-1CC715	33,50€
2	12/180	1	NB1-1-2CC47	30,80€	NB1-1-2CC715	33,50€
3	12/180	1	NB1-1-3CC47	30,80€	NB1-1-3CC715	33,50€
4	12/180	1	NB1-1-4CC47	30,80€	NB1-1-4CC715	33,50€
6	12/180	1	NB1-1-6CC47	18,50€	NB1-1-6CC715	19,60€
10	12/180	1	NB1-1-10CC47	18,50€	NB1-1-10CC715	19,60€
16	12/180	1	NB1-1-16CC47	18,50€	NB1-1-16CC715	19,60€
20	12/180	1	NB1-1-20CC47	18,50€	NB1-1-20CC715	19,60€
25	12/180	1	NB1-1-25CC47	18,50€	NB1-1-25CC715	19,60€
32	12/180	1	NB1-1-32CC47	18,50€	NB1-1-32CC715	19,60€
40	12/180	1	NB1-1-40CC47	27,00€	NB1-1-40CC715	30,50€
50	12/180	1	NB1-1-50CC47	30,80€	NB1-1-50CC715	33,50€
63	12/180	1	NB1-1-63CC47	51,40€	NB1-1-63CC715	54,90€

APARATOS BIPOLARES > Tensión de Utilización: 125Vcc



In (A)	Embalaje	Polos	Referencias y P.V.P.			
			Curva 4~7xIn F2		Curva 7~15xIn F2	
			Referencia	P.V.P.	Referencia	P.V.P.
1	6/90	2	NB1-2-1CC47	50,60€	NB1-2-1CC715	51,70€
2	6/90	2	NB1-2-2CC47	50,60€	NB1-2-2CC715	51,70€
3	6/90	2	NB1-2-3CC47	50,60€	NB1-2-3CC715	51,70€
4	6/90	2	NB1-2-4CC47	50,60€	NB1-2-4CC715	51,70€
6	6/90	2	NB1-2-6CC47	40,00€	NB1-2-6CC715	41,20€
10	6/90	2	NB1-2-10CC47	40,00€	NB1-2-10CC715	41,20€
16	6/90	2	NB1-2-16CC47	40,00€	NB1-2-16CC715	41,20€
20	6/90	2	NB1-2-20CC47	40,00€	NB1-2-20CC715	41,20€
25	6/90	2	NB1-2-25CC47	40,00€	NB1-2-25CC715	41,20€
32	6/90	2	NB1-2-32CC47	40,00€	NB1-2-32CC715	41,20€
40	6/90	2	NB1-2-40CC47	52,90€	NB1-2-40CC715	54,10€
50	6/90	2	NB1-2-50CC47	89,40€	NB1-2-50CC715	94,00€
63	6/90	2	NB1-2-63CC47	95,20€	NB1-2-63CC715	98,70€

DZ158

Interruptores automáticos

SECTOR INDUSTRIAL

CE	S	005	PG	RCC
U.E	Suecia	Ucrania	Rusia	Sudáfrica

Polos	1,2,3,4P (27mm por módulo)
Intensidad Nominal	63,80,100,125A
Poder de corte	10kA (10.000A)
Curvas	8~12xIn
Norma	UNE-EN60947-2



F2	Referencia	Polos	Intensidad nominal	Curva	Embalaje	P.V.P.
	DZ158-1-63	1P	63	8~12	12/108	39,90€
	DZ158-1-80	1P	80	8~12	12/108	50,00€
	DZ158-1-100	1P	100	8~12	12/108	57,40€
	DZ158-1-125	1P	125	8~12	12/108	65,60€



F2	Referencia	Polos	Intensidad nominal	Curva	Embalaje	P.V.P.
	DZ158-2-63	2P	63	8~12	6/54	77,70€
	DZ158-2-80	2P	80	8~12	6/54	94,20€
	DZ158-2-100	2P	100	8~12	6/54	97,70€
	DZ158-2-125	2P	125	8~12	6/54	122,80€



F2	Referencia	Polos	Intensidad nominal	Curva	Embalaje	P.V.P.
	DZ158-3-63	3P	63	8~12	4/36	98,30€
	DZ158-3-80	3P	80	8~12	4/36	109,30€
	DZ158-3-100	3P	100	8~12	4/36	130,80€
	DZ158-3-125	3P	125	8~12	4/36	164,10€



F2	Referencia	Polos	Intensidad nominal	Curva	Embalaje	P.V.P.
	DZ158-4-63	4P	63	8~12	3/27	124,90€
	DZ158-4-80	4P	80	8~12	3/27	162,20€
	DZ158-4-100	4P	100	8~12	3/27	172,90€
	DZ158-4-125	4P	125	8~12	3/27	239,40€



PSP

Protectores contra Sobretensiones Permanentes



F4	Referencia	Polos	Tensión	Módulos (18mm)	Embalaje	Para montar junto con interruptores	P.V.P.
	PSP230V/M	1P+N	230Vca	1	12/120	eB, UB, DZ158 Bipolares	96,30€
	PSP400V/M	3P+N	400Vca	3	4/40	UB, DZ158 Tetrapolares	283.50€

Nota: Estos aparatos se suministran normalmente montados junto con el interruptor automático que el cliente solicite.
El PVP indicado corresponde únicamente al protector de sobretensiones



NU9-PR

Protectores contra Sobretensiones Permanentes



F4	Referencia	Polos	Tensión	Módulos (18mm)	Embalaje	Sistema de montaje	P.V.P.
	NU9-PR230	1P+N	230Vca	1	1	independiente	96,30€
	NU9-PR400	3P+N	400Vca	3	1	independiente	293.50€



Accesorios eléctricos

Para interruptores automáticos



F4	Referencia	Embalaje	Polos	Anchura	Para interruptores	P.V.P.
Bobinas de emisión de corriente (Disparo por un impulso de tensión)						
	S9-230VCA	10	1	18mm	NB1, NBH8, NB1L	36,05€
	S9-24VCC	10	1	18mm	NB1, NBH8, NB1L	36,05€
	S9-48VCC	10	1	18mm	NB1, NBH8, NB1L	36,05€
Bobinas de mínima tensión (Disparo por fallo de tensión)						
	V9-24VCA	10	1	18mm	NB1, NBH8, NB1L	36,05€
	V9-230VCA	10	1	18mm	NB1, NBH8, NB1L	36,05€
Contactos de alarma (señalización de "disparado")						
	XF9J	10	1/2	9mm	NB1, NBH8, NB1L	26,20€
Contactos de señalización (señalización "Abierto"/"Cerrado")						
	XF9	10	1/2	9mm	NB1, NBH8, NB1L	26,10€
	AUX-1	1/12	1/2	9mm	DZ158	25,80€



NU6-I

Protectores contra sobretensiones transitorias

Clase/Tipo	I
Categoría de protección	III
Corriente de choque	40kA, Onda 10/350µs
Norma	UNE-EN61643-1



F4	Corriente de choque (I _{imp})	Tipo de Onda	Corriente nominal de descarga	Polos	Módulos 18mm	Tensión de servicio (Uc)	Embalaje	Referencia	P.V.P.
	40kA	10/350µs	50kA	1	2	440V	10/180	NU6-I/40/440	134,10€

NU6-II

Protectores contra sobretensiones transitorias

CARTUCHO RECAMBIABLE

Clase/Tipo	II
Categoría de protección	II
Corrientes de choque	15,25,40kA, Onda 8/20µs
Norma	UNE-EN61643-1



F4	Corriente nominal de descarga	Corriente máxima de descarga	Polos	Módulos 18mm	Tensión de servicio (Uc)	Nivel de protección (Up)	Embalaje	Referencia	P.V.P.
	15kA	40kA	2	2	385V	1,8kV	6/90	NU6-II/2/15/385	81,30€
	25kA	60kA	2	2	385V	1,8kV	6/90	NU6-II/2/25/385	91,30€
	40kA	100kA	2	4	385V	1,8kV	4/45	NU6-II/2/40/385	96,30€

F4	Corriente nominal de descarga	Corriente máxima de descarga	Polos	Módulos 18mm	Tensión de servicio (Uc)	Nivel de protección (Up)	Embalaje	Referencia	P.V.P.
	15kA	40kA	4	4	460	2,0kV	3/45	NU6-II/4/15/460	146,30€
	25kA	60kA	4	4	460	2,0kV	3/45	NU6-II/4/25/460	158,30€
	25kA	60kA	4	4	510	2,5kV	3/45	NU6-II/4/25/510	158,30€
	25kA	60kA	4	4	550	3,0kV	3/45	NU6-II/4/25/550	158,30€
	40kA	100kA	4	8	460	2,0kV	2/15	NU6-II/4/40/460	167,30€

NU6-III

Protectores contra sobretensiones transitorias

USO DOMÉSTICO

Clase/Tipo	III
Categoría de protección	I
Tensión de cortocircuito (Uoc)	10kV, Onda 1,2/50µs
Norma	UNE-EN61643-1



F4	Tensión de cortocircuito	Polos	Módulos 18mm	Tensión de servicio (Uc)	Nivel de protección (Up)	Embalaje	Referencia	P.V.P.
	10kV	2	1	385V	1,5kV	12/180	NU6-III/10/385E	82,50€

	Protector de sobretensión	Corriente nominal de descarga	Interruptor automático
Todos los protectores contra sobretensiones transitorias deben protegerse aguas arriba con un interruptor automático de las características que se indican en el cuadro de la derecha.	NU6-I	TODAS	NM8-125S 100A
	NU6-II	5	10A, curva C
		15	20A, curva C
		25	40A, curva C
	40	63A, curva C	
NU6-III	TODAS	10A, curva C	

Notas:

* Los aparatos incluidos en la presente Lista de Precios son los de uso general.

Para aparatos de otras características consultar Catálogo General

* Bajo demanda pueden suministrarse todos los modelos con puerto de control remoto

NL1

Interruptores diferenciales

CE	N	S	FI	EC	005	PG	RCC
U.E.	España	Suecia	Finlandia	Chequia	Ucrania	Rusia	Sudáfrica

Polos	2,4P
Intensidad Nominal	25,40,63A
Poder de corte	6kA (6.000A) y 10kA (10.000A)
Sensibilidades	30,300mA, 100mA bajo demanda
Clases	A, AC, ASi (Superinmunizado)
Norma	UNE-EN61008-1

PODER DE CORTE: 6kA (6.000A)



F1	In (A)	I Δ n (mA)	Polos	Embal.	Referencia Clase A	P.V.P.	Referencia Clase AC	P.V.P.	Referencia Clase ASi (superinmunizados)	P.V.P.
	16	10	2	1/90	-	-	NL1-2-16-10AC	85,90€	-	-
	25	30	2	1/90	NL1-2-25-30A	60,25€	NL1-2-25-30AC	35,40€	NL1-2-25-30ASi	169,90€
	40	30	2	1/90	NL1-2-40-30A	68,50€	NL1-2-40-30AC	36,60€	NL1-2-40-30ASi	172,30€
	63	30	2	1/90	NL1-2-63-30A	229,60€	NL1-2-63-30AC	214,60€	NL1-2-63-30ASi	328,65€
	25	300	2	1/90	NL1-2-25-300A	121,20€	NL1-2-25-300AC	79,90€	NL1-2-25-300ASi	210,60€
	40	300	2	1/90	NL1-2-40-300A	125,30€	NL1-2-40-300AC	82,60€	NL1-2-40-300ASi	220,10€
	63	300	2	1/90	NL1-2-63-300A	203,10€	NL1-2-63-300AC	156,00€	NL1-2-63-300ASi	286,10€



F1	In (A)	I Δ n (mA)	Polos	Embal.	Referencia Clase A	P.V.P.	Referencia Clase AC	P.V.P.	Referencia Clase ASi (superinmunizados)	P.V.P.
	25	30	4	1/45	NL1-4-25-30A	188,70€	NL1-4-25-30AC	161,10€	NL1-4-25-30ASi	298,45€
	40	30	4	1/45	NL1-4-40-30A	206,90€	NL1-4-40-30AC	161,10€	NL1-4-40-30ASi	310,10€
	63	30	4	1/45	NL1-4-63-30A	??	NL1-4-63-30AC	179,10€	NL1-4-63-30ASi	460,50€
	25	300	4	1/45	NL1-4-25-300A	159,70€	NL1-4-25-300AC	138,40€	NL1-4-25-300ASi	290,50€
	40	300	4	1/45	NL1-4-40-300A	177,40€	NL1-4-40-300AC	141,10€	NL1-4-40-300ASi	299,75€
	63	300	4	1/45	NL1-4-63-300A	??	NL1-4-63-300AC	179,10€	NL1-4-63-300ASi	340,30€

Nota: Bajo demanda pueden suministrarse diferenciales de 100mA de sensibilidad.

PODER DE CORTE: 10kA (10.000A)



F1	In (A)	I Δ n (mA)	Polos	Embal.	Referencia Clase A	P.V.P.	Referencia Clase AC	P.V.P.
	25	30	2	1/90	NL1-2-25-30A10	128,80€	NL1-2-25-30AC10	77,70€
	40	30	2	1/90	NL1-2-40-30A10	130,70€	NL1-2-40-30AC10	80,20€
	63	30	2	1/90	NL1-2-63-30A10	213,40€	NL1-2-63-30AC10	222,50€
	25	300	2	1/90	NL1-2-25-300A10	123,45€	NL1-2-25-300AC10	80,50€
	40	300	2	1/90	NL1-2-40-300A10	127,60€	NL1-2-40-300AC10	82,10€
	63	300	2	1/90	NL1-2-63-300A10	207,20€	NL1-2-63-300AC10	158,90€



F1	In (A)	I Δ n (mA)	Polos	Embal.	Referencia Clase A	P.V.P.	Referencia Clase AC	P.V.P.
	25	30	4	1/45	NL1-4-25-30A10	192,10€	NL1-4-25-30AC10	160,60€
	40	30	4	1/45	NL1-4-40-30A10	212,80€	NL1-4-40-30AC10	166,20€
	63	30	4	1/45	NL1-4-63-30A10	383,50€	NL1-4-63-30AC10	348,10€
	25	300	4	1/45	NL1-4-25-300A10	158,70€	NL1-4-25-300AC10	140,50€
	40	300	4	1/45	NL1-4-40-300A10	180,10€	NL1-4-40-300AC10	142,90€
	63	300	4	1/45	NL1-4-63-300A10	242,50€	NL1-4-63-300AC10	200,00€

NL1 Interruptores diferenciales Selectivos



Polos	2,4P
Intensidad Nominal	63,80,100A
Poder de corte	10kA (10.000A)
Sensibilidades	300mA
Clases	AS, ACS (Selectivos)
Norma	UNE-EN61008-1

PODER DE CORTE: 10kA (10.000A)



F1	In (A)	IΔn (mA)	Polos	Embal.	Referencia Clase A	P.V.P.	Referencia Clase AC	P.V.P.
	63	300	2	1/90	NL1-2-63-300AS	267,70€	NL1-2-63-300ACS	249,50€
	80	300	2	1/90	NL1-2-80-300AS	422,10€	NL1-2-80-300ACS	398,60€
	100	300	2	1/90	NL1-2-100-300AS	426,20€	NL1-2-100-300ACS	410,90€



F1	In (A)	IΔn (mA)	Polos	Embal.	Referencia Clase A	P.V.P.	Referencia Clase AC	P.V.P.
	63	300	4	1/45	NL1-4-63-300AS	389,20€	NL1-4-63-300ACS	313,60€
	80	300	4	1/45	NL1-4-80-300AS	489,20€	NL1-4-80-300ACS	425,30€
	100	300	4	1/45	NL1-4-100-300AS	514,70€	NL1-4-100-300ACS	527,50€

NB1L Interruptores diferenciales combinados con automático



Polos	1P+N,2P
Intensidad Nominal	6,10,16,20,25,32,40A
Poder de corte	6kA (6.000A) y 10kA (10.000A)
Sensibilidades	30mA
Clases	A
Curvas	C
Norma	UNE-EN61008-1



F1	In (A)	IΔn (mA)	Polos	Módulos 18mm	Curva	Poder de corte	Embal.	Referencia Clase A	P.V.P.
	6	30	1+N	2	C	6kA	1	NB1L-1N-6C30A/2	89,50€
	10	30	1+N	2	C	6kA	1	NB1L-1N-10C30A/2	87,40€
	16	30	1+N	2	C	6kA	1	NB1L-1N-16C30A/2	87,80€
	20	30	1+N	2	C	6kA	1	NB1L-1N-20C30A/2	90,30€
	25	30	1+N	2	C	6kA	1	NB1L-1N-25C30A/2	90,70€
	32	30	1+N	2	C	6kA	1	NB1L-1N-32C30A/2	92,30€
	40	30	1+N	2	C	6kA	1	NB1L-1N-40C30A/2	98,50€



F1	In (A)	IΔn (mA)	Polos	Módulos 18mm	Curva	Poder de corte	Embal.	Referencia Clase A	P.V.P.
	6	30	2	3	C	10kA	1	NB1L-2-6C30A10/3	102,80€
	10	30	2	3	C	10kA	1	NB1L-2-10C30A10/3	100,40€
	16	30	2	3	C	10kA	1	NB1L-2-16C30A10/3	100,90€
	20	30	2	3	C	10kA	1	NB1L-2-20C30A10/3	102,60€
	25	30	2	3	C	10kA	1	NB1L-2-25C30A10/3	103,90€
	32	30	2	3	C	10kA	1	NB1L-2-32C30A10/3	106,30€
	40	30	2	3	C	10kA	1	NB1L-2-40C30A10/3	108,90€

NB1L
Interruptores automáticos con bloque diferencial.

U.E	Holanda	Suecia	Finlandia	Ucrania	Rusia

Polos	1P+N,2,3,4P
Intensidad Nominal	6,10,16,20,25,32,40,50,63A
Poder de corte	6kA (6.000A)
Sensibilidades	30,300mA
Clases	A,AC
Curvas	C
Norma	UNE-EN60898-1

1P+N 6 a 40A: 2,5 módulos/45mm; 50,63A: 3 módulos/54mm



F1	In (A)	IΔn (mA)	Embal.	Referencia Clase A	P.V.P.	Referencia Clase AC	P.V.P.
	6	30	1/60	NB1L-1N-6C30A	103,20€	NB1L-1N-6C30AC	95,60€
	10	30	1/60	NB1L-1N-10C30A	101,20€	NB1L-1N-10C30AC	93,20€
	16	30	1/60	NB1L-1N-16C30A	107,90€	NB1L-1N-16C30AC	93,70€
	20	30	1/60	NB1L-1N-20C30A	108,90€	NB1L-1N-20C30AC	95,40€
	25	30	1/60	NB1L-1N-25C30A	111,20€	NB1L-1N-25C30AC	96,70€
	32	30	1/60	NB1L-1N-32C30A	112,90€	NB1L-1N-32C30AC	99,10€
	40	30	1/60	NB1L-1N-40C30A	116,30€	NB1L-1N-40C30AC	101,70€
	50	30	1/60	-	-	NB1L-1N-50C30AC	119,20€
	63	30	1/60	-	-	NB1L-1N-63C30AC	130,10€
	6	300	1/60	NB1L-1N-6C300A	104,40€	NB1L-1N-6C300AC	90,80€
	10	300	1/60	NB1L-1N-10C300A	102,25€	NB1L-1N-10C300AC	88,50€
	16	300	1/60	NB1L-1N-16C300A	93,50€	NB1L-1N-16C300AC	89,00€
	20	300	1/60	NB1L-1N-20C300A	103,20€	NB1L-1N-20C300AC	90,65€
	25	300	1/60	NB1L-1N-25C300A	105,30€	NB1L-1N-25C300AC	91,50€
	32	300	1/60	NB1L-1N-32C300A	108,30€	NB1L-1N-32C300AC	93,60€
	40	300	1/60	NB1L-1N-40C300A	110,35€	NB1L-1N-40C300AC	95,90€
	50	300	1/60	-	-	NB1L-1N-50C300AC	113,05€
	63	300	1/60	-	-	NB1L-1N-63C300AC	125,50€

2P 6 a 40A: 3,5 módulos/63mm; 50,63A: 4 módulos/72mm



F1	In (A)	IΔn (mA)	Embal.	Referencia Clase A	P.V.P.	Referencia Clase AC	P.V.P.
	6	30	1/48	NB1L-2-6C30A	120,60€	NB1L-2-6C30AC	100,60€
	10	30	1/48	NB1L-2-10C30A	112,70€	NB1L-2-10C30AC	98,00€
	16	30	1/48	NB1L-2-16C30A	113,20€	NB1L-2-16C30AC	98,50€
	20	30	1/48	NB1L-2-20C30A	115,10€	NB1L-2-20C30AC	100,40€
	25	30	1/48	NB1L-2-25C30A	116,90€	NB1L-2-25C30AC	101,70€
	32	30	1/48	NB1L-2-32C30A	119,80€	NB1L-2-32C30AC	104,20€
	40	30	1/48	NB1L-2-40C30A	123,00€	NB1L-2-40C30AC	107,00€
	50	30	1/48	-	-	NB1L-2-50C30AC	120,10€
	63	30	1/48	-	-	NB1L-2-63C30AC	131,25€
	6	300	1/48	NB1L-2-6C300A	109,90€	NB1L-2-6C-300AC	95,60€
	10	300	1/48	NB1L-2-10C300A	107,20€	NB1L-2-10C300AC	93,20€
	16	300	1/48	NB1L-2-16C300A	107,90€	NB1L-2-16C300AC	93,60€
	20	300	1/48	NB1L-2-20C300A	109,70€	NB1L-2-20C300AC	95,40€
	25	300	1/48	NB1L-2-25C300A	110,40€	NB1L-2-25C300AC	95,95€
	32	300	1/48	NB1L-2-32C300A	113,60€	NB1L-2-32C300AC	98,80€
	40	300	1/48	NB1L-2-40C300A	116,80€	NB1L-2-40C300AC	101,65€
	50	300	1/48	-	-	NB1L-2-50C300AC	114,90€
	63	300	1/48	-	-	NB1L-2-63C300AC	124,40€

3P 6 a 40A: 6 módulos/108mm; 50,63A: 6,5 módulos/117mm



F1	In (A)	IΔn (mA)	Embal.	Referencia Clase A	P.V.P.	Referencia Clase AC	P.V.P.
	6	30	1/24	NB1L-3-6C30A	144,55€	NB1L-3-6C30AC	125,70€
	10	30	1/24	NB1L-3-10C30A	140,90€	NB1L-3-10C30AC	122,60€
	16	30	1/24	NB1L-3-16C30A	141,70€	NB1L-3-16C30AC	123,20€
	20	30	1/24	NB1L-3-20C30A	144,20€	NB1L-3-20C30AC	125,40€
	25	30	1/24	NB1L-3-25C30A	146,10€	NB1L-3-25C30AC	127,00€
	32	30	1/24	NB1L-3-32C30A	150,20€	NB1L-3-32C30AC	130,10€
	40	30	1/24	NB1L-3-40C30A	155,40€	NB1L-3-40C30AC	133,30€
	50	30	1/24	-	-	NB1L-3-50C30AC	142,10€
	63	30	1/24	-	-	NB1L-3-63C30AC	152,80€
	6	300	1/24	NB1L-3-6C300A	133,40€	NB1L-3-6C300AC	116,50€
	10	300	1/24	NB1L-3-10C300A	119,60€	NB1L-3-10C300AC	104,20€
	16	300	1/24	NB1L-3-16C300A	120,10€	NB1L-3-16C300AC	104,70€
	20	300	1/24	NB1L-3-20C300A	136,80€	NB1L-3-20C300AC	119,15€
	25	300	1/24	NB1L-3-25C300A	138,20€	NB1L-3-25C300AC	120,70€
	32	300	1/24	NB1L-3-32C300A	142,10€	NB1L-3-32C300AC	123,80€
	40	300	1/24	NB1L-3-40C300A	144,90€	NB1L-3-40C300AC	126,40€
	50	300	1/24	-	-	NB1L-3-50C300AC	134,80€
	63	300	1/24	-	-	NB1L-3-63C300AC	145,20€

4P 6 a 40A: 7 módulos/126mm; 50,63A: 7,5 módulos/135mm



F1	In (A)	IΔn (mA)	Embal.	Referencia Clase A	P.V.P.	Referencia Clase AC	P.V.P.
	6	30	1/24	NB1L-4-6C30A	170,10€	NB1L-4-6C30AC	147,90€
	10	30	1/24	NB1L-4-10C30A	165,60€	NB1L-4-10C30AC	144,40€
	16	30	1/24	NB1L-4-16C30A	165,90€	NB1L-4-16C30AC	144,90€
	20	30	1/24	NB1L-4-20C30A	169,10€	NB1L-4-20C30AC	147,70€
	25	30	1/24	NB1L-4-25C30A	171,40€	NB1L-4-25C30AC	149,40€
	32	30	1/24	NB1L-4-32C30A	176,10€	NB1L-4-32C30AC	153,10€
	40	30	1/24	NB1L-4-40C30A	180,70€	NB1L-4-40C30AC	157,10€
	50	30	1/24	-	-	NB1L-4-50C30AC	166,30€
	63	30	1/24	-	-	NB1L-4-63C30AC	171,30€
	6	300	1/24	NB1L-4-6C300A	160,60€	NB1L-4-6C300AC	139,65€
	10	300	1/24	NB1L-4-10C300A	157,30€	NB1L-4-10C300AC	136,80€
	16	300	1/24	NB1L-4-16C300A	158,60€	NB1L-4-16C300AC	137,60€
	20	300	1/24	NB1L-4-20C300A	161,10€	NB1L-4-20C300AC	140,00€
	25	300	1/24	NB1L-4-25C300A	163,20€	NB1L-4-25C300AC	141,95€
	32	300	1/24	NB1L-4-32C300A	167,30€	NB1L-4-32C300AC	145,40€
	40	300	1/24	NB1L-4-40C300A	171,35€	NB1L-4-40C300AC	149,20€
	50	300	1/24	-	-	NB1L-4-50C300AC	157,70€
	63	300	1/24	-	-	NB1L-4-63C300AC	162,50€

NB1L
Interruptores automáticos con bloque diferencial.

Polos	1P+N, 2, 3, 4P
Intensidad Nominal	6, 10, 16, 20, 25, 32, 40A
Poder de corte	10kA (10.000A)
Sensibilidades	30, 300mA
Clases	A, AC
Curvas	C
Norma	UNE-EN60898-1

1P+N - 2,5 módulos/45mm

F1	In (A)	IΔn (mA)	Embal.	Referencia Clase A	P.V.P.	Referencia Clase AC	P.V.P.
	6	30	1/60	NB1L-1N-6C30A10	116,20€	NB1L-1N-6C30AC10	104,60€
	10	30	1/60	NB1L-1N-10C30A10	114,50€	NB1L-1N-10C30AC10	102,50€
	16	30	1/60	NB1L-1N-16C30A10	114,70€	NB1L-1N-16C30AC10	102,70€
	20	30	1/60	NB1L-1N-20C30A10	116,45€	NB1L-1N-20C30AC10	104,40€
	25	30	1/60	NB1L-1N-25C30A10	117,30€	NB1L-1N-25C30AC10	105,80€
	32	30	1/60	NB1L-1N-32C30A10	120,90€	NB1L-1N-32C30AC10	108,30€
	40	30	1/60	NB1L-1N-40C30A10	123,15€	NB1L-1N-40C30AC10	111,90€
	6	300	1/60	NB1L-1N-6C300A10	108,60€	NB1L-1N-6C300AC10	98,80€
	10	300	1/60	NB1L-1N-10C300A10	110,80€	NB1L-1N-10C300AC10	99,10€
	16	300	1/60	NB1L-1N-16C300A10	111,10€	NB1L-1N-16C300AC10	99,40€
	20	300	1/60	NB1L-1N-20C300A10	109,30€	NB1L-1N-20C300AC10	101,20€
	25	300	1/60	NB1L-1N-25C300A10	110,10€	NB1L-1N-25C300AC10	103,30€
	32	300	1/60	NB1L-1N-32C300A10	115,20€	NB1L-1N-32C300AC10	106,10€
	40	300	1/60	NB1L-1N-40C300A10	117,40€	NB1L-1N-40C300AC10	109,10€

2P - 3,5 módulos/63mm

F1	In (A)	IΔn (mA)	Embal.	Referencia Clase A	P.V.P.	Referencia Clase AC	P.V.P.
	6	30	1/48	NB1L-2-6C30A10	129,10€	NB1L-2-6C30AC10	112,20€
	10	30	1/48	NB1L-2-10C30A10	125,30€	NB1L-2-10C30AC10	109,90€
	16	30	1/48	NB1L-2-16C30A10	126,10€	NB1L-2-16C30AC10	110,70€
	20	30	1/48	NB1L-2-20C30A10	128,80€	NB1L-2-20C30AC10	112,40€
	25	30	1/48	NB1L-2-25C30A10	132,50€	NB1L-2-25C30AC10	114,30€
	32	30	1/48	NB1L-2-32C30A10	135,70€	NB1L-2-32C30AC10	118,50€
	40	30	1/48	NB1L-2-40C30A10	141,40€	NB1L-2-40C30AC10	123,40€
	6	300	1/48	NB1L-2-6C300A10	121,90€	NB1L-2-6C300AC10	106,80€
	10	300	1/48	NB1L-2-10C300A10	118,40€	NB1L-2-10C300AC10	103,60€
	16	300	1/48	NB1L-2-16C300A10	119,60€	NB1L-2-16C300AC10	104,10€
	20	300	1/48	NB1L-2-20C300A10	121,90€	NB1L-2-20C300AC10	106,40€
	25	300	1/48	NB1L-2-25C300A10	124,20€	NB1L-2-25C300AC10	108,30€
	32	300	1/48	NB1L-2-32C300A10	128,80€	NB1L-2-32C300AC10	112,60€
	40	300	1/48	NB1L-2-40C300A10	134,30€	NB1L-2-40C300AC10	116,80€

3P - 6 módulos/108mm

F1	In (A)	I Δ n (mA)	Embal.	Referencia Clase A	P.V.P.	Referencia Clase AC	P.V.P.
	6	30	1/24	NB1L-3-6C30A10	131,80€	NB1L-3-6C30AC10	114,40€
	10	30	1/24	NB1L-3-10C30A10	128,60€	NB1L-3-10C30AC10	112,20€
	16	30	1/24	NB1L-3-16C30A10	128,80€	NB1L-3-16C30AC10	112,90€
	20	30	1/24	NB1L-3-20C30A10	131,70€	NB1L-3-20C30AC10	114,30€
	25	30	1/24	NB1L-3-25C30A10	132,20€	NB1L-3-25C30AC10	115,50€
	32	30	1/24	NB1L-3-32C30A10	135,70€	NB1L-3-32C30AC10	118,80€
	40	30	1/24	NB1L-3-40C30A10	140,30€	NB1L-3-40C30AC10	122,10€
	6	300	1/24	NB1L-3-6C300A10	123,10€	NB1L-3-6C300AC10	107,80€
	10	300	1/24	NB1L-3-10C300A10	125,30€	NB1L-3-10C300AC10	109,10€
	16	300	1/24	NB1L-3-16C300A10	127,20€	NB1L-3-16C300AC10	109,80€
	20	300	1/24	NB1L-3-20C300A10	129,90€	NB1L-3-20C300AC10	111,60€
	25	300	1/24	NB1L-3-25C300A10	130,10€	NB1L-3-25C300AC10	113,80€
	32	300	1/24	NB1L-3-32C300A10	133,90€	NB1L-3-32C300AC10	115,60€
	40	300	1/24	NB1L-3-40C300A10	137,10€	NB1L-3-40C300AC10	119,30€

4P - 7 módulos/126mm

F1	In (A)	I Δ n (mA)	Embal.	Referencia Clase A	P.V.P.	Referencia Clase AC	P.V.P.
	6	30	1/24	NB1L-4-6C30A10	156,40€	NB1L-4-6C30AC10	136,80€
	10	30	1/24	NB1L-4-10C30A10	154,90€	NB1L-4-10C30AC10	134,40€
	16	30	1/24	NB1L-4-16C30A10	155,10€	NB1L-4-16C30AC10	134,80€
	20	30	1/24	NB1L-4-20C30A10	156,80€	NB1L-4-20C30AC10	136,80€
	25	30	1/24	NB1L-4-25C30A10	158,70€	NB1L-4-25C30AC10	138,10€
	32	30	1/24	NB1L-4-32C30A10	162,60€	NB1L-4-32C30AC10	141,60€
	40	30	1/24	NB1L-4-40C30A10	167,90€	NB1L-4-40C30AC10	146,40€
	6	300	1/24	NB1L-4-6C300A10	151,20€	NB1L-4-6C300AC10	130,80€
	10	300	1/24	NB1L-4-10C300A10	149,50€	NB1L-4-10C300AC10	129,60€
	16	300	1/24	NB1L-4-16C300A10	151,30€	NB1L-4-16C300AC10	130,40€
	20	300	1/24	NB1L-4-20C300A10	152,10€	NB1L-4-20C300AC10	132,20€
	25	300	1/24	NB1L-4-25C300A10	154,20€	NB1L-4-25C300AC10	135,60€
	32	300	1/24	NB1L-4-32C300A10	158,20€	NB1L-4-32C300AC10	138,10€
	40	300	1/24	NB1L-4-40C300A10	165,60€	NB1L-4-40C300AC10	142,60€

DZ158LE

Interruptores automáticos con bloque diferencial.



Polos	2,3,4P
Intensidad Nominal	63,80,100A
Poder de corte	6kA (6.000A)
Sensibilidades	30,300mA
Clases	AC
Curvas	C
Norma	UNE-EN61008-1



F3	In (A)	IΔn (mA)	Polos	Módulos 18mm	Curva	Poder de corte	Embal.	Referencia Clase AC	P.V.P.
	63	30	2	4,5	C	6kA	1/36	DZ158LE-2-63C30AC	135,70€
	80	30	2	4,5	C	6kA	1/36	DZ158LE-2-80C30AC	149,80€
	100	30	2	4,5	C	6kA	1/36	DZ158LE-2-100C30AC	182,10€
	63	300	2	4,5	C	6kA	1/36	DZ158LE-2-63C300AC	132,80€
	80	300	2	4,5	C	6kA	1/36	DZ158LE-2-80C300AC	145,20€
	100	300	2	4,5	C	6kA	1/36	DZ158LE-2-100C300AC	175,40€



F3	In (A)	IΔn (mA)	Polos	Módulos 18mm	Curva	Poder de corte	Embal.	Referencia Clase AC	P.V.P.
	63	30	3	6	C	6kA	1/27	DZ158LE-3-63C30AC	143,10€
	80	30	3	6	C	6kA	1/27	DZ158LE-3-80C30AC	168,80€
	100	30	3	6	C	6kA	1/27	DZ158LE-3-100C30AC	198,80€
	63	300	3	6	C	6kA	1/27	DZ158LE-3-63C300AC	138,80€
	80	300	3	6	C	6kA	1/27	DZ158LE-3-80C300AC	184,90€
	100	300	3	6	C	6kA	1/27	DZ158LE-3-100C300AC	192,90€



F3	In (A)	IΔn (mA)	Polos	Módulos 18mm	Curva	Poder de corte	Embal.	Referencia Clase AC	P.V.P.
	63	30	4	7,5	C	6kA	1/18	DZ158LE-4-63C30AC	221,20€
	80	30	4	7,5	C	6kA	1/18	DZ158LE-4-80C30AC	234,60€
	100	30	4	7,5	C	6kA	1/18	DZ158LE-4-100C30AC	260,20€
	63	300	4	7,5	C	6kA	1/18	DZ158LE-4-63C300AC	214,60€
	80	300	4	7,5	C	6kA	1/18	DZ158LE-4-80C300AC	230,00€
	100	300	4	7,5	C	6kA	1/18	DZ158LE-4-100C300AC	253,20€

Información general acerca de la protección diferencial.

Protección contra riesgos de incendio debidos a contactos directos a tierra en las cuales la corriente de defecto no es suficiente para causar el disparo de las protecciones contra sobrecorrientes.

Protección contra riesgo de descargas y electrocuciones por contactos indirectos con otras masas o equipos debidos a defectos a tierra de los aparatos.

Protección contra riesgo de descargas y electrocuciones por contactos en ambientes potencialmente peligrosos.

Cómo protección suplementaria contra descargas contra contactos directos con partes bajo tensión.

Nota: Un interruptor diferencial no debe ser utilizado como protección exclusiva contra contactos directos con partes bajo tensión, contactos que deben ser protegidos, contra sobrecargas y cortocircuitos, por interruptores automáticos



Reglas para la elección de Interruptores Diferenciales

a. Corrientes nominales de defecto a tierra

10mA - Proporciona un elevado grado de protección contra descargas eléctricas en ambientes peligrosos en los cuales se requiera una protección suplementaria contra contactos directos accidentales.

30mA - Proporciona un elevado grado de protección contra descargas eléctricas en situaciones donde se requiera una protección suplementaria contra contactos directos accidentales cuando sea necesaria una desconexión en 40 milisegundos si se detecta una corriente de defecto de 150mA.

300mA - Proporciona una protección global contra defectos a tierra en cables, etc. únicamente cuando una corriente suficiente (generalmente por debajo de 500mA) pueda causar incandescencia en partes metálicas, descargas eléctricas, etc., tomando en consideración que las protecciones por sobrecorriente requieren, para desconectar el circuito, una cantidad de corriente mucho mayor que 300mA.

b. Clases de desconexión

Clase AC - Desconexión por defectos a tierra producidos por corrientes alternas sinusoidales, tanto si éstas son aplicadas instantáneamente como si se incrementan lentamente.

Clase A - Desconexión por defectos a tierra producidos por corrientes alternas sinusoidales o por corrientes continuas pulsantes, tanto si éstas son aplicadas instantáneamente como si se incrementan lentamente.

Clase **S** - SELECTIVO. Puede ser usado aguas arriba de la instalación para obtener una coordinación selectiva con los diferenciales instalados aguas abajo, en el propio cuadro.

Los diferenciales estándar son, habitualmente, de disparo instantáneo. Esto significa que la conexión en serie de este tipo de aparatos no provee de una coordinación de disparo selectivo en caso de defecto a tierra.

Para obtener una correcta selectividad de desconexión de los diferenciales es necesario conectar, por encima de todos los diferenciales instantáneos uno o más diferenciales retardados (tipos AC-S o A-S)

Clase ASi - Superinmunizados. Desconexión por defectos a tierra producidos por corrientes alternas sinusoidales o por corrientes continuas pulsantes, tanto si éstas son aplicadas instantáneamente como si se incrementan lentamente.

Incorporan además filtros para discriminación de señales de disparo producidas por altas frecuencias, transitorios, etc. debidas a los equipos electrónicos instalados en la red eléctrica.

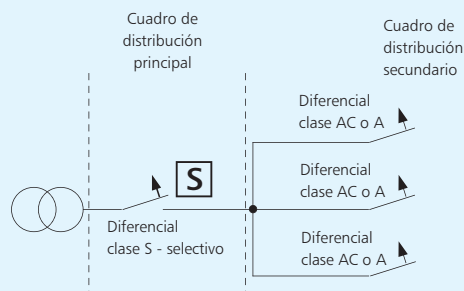

NH4 Seccionadores manuales

U.E	Alemania	Suecia	Chequia	Rusia



Polos	1,2,3,4P
Intensidad Nominal	32,63,100,125A
Poder de corte	12xIn
Norma	UNE-EN60947-3

F1	In (A)	Polos	Embalaje	Referencia	P.V.P.
	32	1	12/180	NH4-1-32	8,70€
	63	1	12/180	NH4-1-63	14,40€
	100	1	12/180	NH4-1-100	15,40€
	125	1	12/180	NH4-1-125	23,10€

F1	In (A)	Polos	Embalaje	Referencia	P.V.P.
	32	2	6/90	NH4-2-32	12,70€
	63	2	6/90	NH4-2-63	19,10€
	100	2	6/90	NH4-2-100	42,00€
	125	2	6/90	NH4-2-125	46,85€

F1	In (A)	Polos	Embalaje	Referencia	P.V.P.
	32	3	4/60	NH4-3-32	17,00€
	63	3	4/60	NH4-3-63	36,90€
	100	3	4/60	NH4-3-100	50,40€
	125	3	4/60	NH4-3-125	63,70€

F1	In (A)	Polos	Embalaje	Referencia	P.V.P.
	32	4	3/45	NH4-4-32	21,20€
	63	4	3/45	NH4-4-63	44,60€
	100	4	3/45	NH4-4-100	66,10€
	125	4	3/45	NH4-4-125	79,40€

NH9 Seccionadores manuales Palanca bloqueable y precintable en posiciones abierto y cerrado.

U.E	Suecia



Polos	1,2,3,4P (1 módulo 18mm)
Intensidad Nominal	32A
Poder de corte	20xIn
Norma	UNE-EN60947-3

F1	In (A)	Polos	Embalaje	Referencia	P.V.P.
	32	1	12/180	NH9-1-32	11,70€
	32	2	12/180	NH9-2-32	18,70€
	32	3	12/180	NH9-3-32	26,00€
	32	4	12/180	NH9-4-32	33,20€

NZK1, NZK2 Conmutadores



Anchura	1 módulo 18mm
Polos	1P, 2P, 3P
Intensidad Nominal	32A/230Vca
Tipos	NZK1 I-0-II - NZK2: I-II
Norma	UNE-EN60669-1



F1	Referencia	Polos	Corriente (A)	Posiciones	Tensión (V)	Embalaje	P.V.P.
	NZK1-1-32	1	32	I-0-II	250Vca	12/120	11,50€
	NZK1-2-32	2	32	I-0-II	250Vca	12/120	22,90€
	NZK1-3-32	3	32	I-0-II	250Vca	12/120	30,10€
	NZK2-1-32	1	32	I-II	250Vca	12/120	10,85€
	NZK2-2-32	2	32	I-II	250Vca	12/120	20,45€
	NZK2-3-32	3	32	I-II	250Vcc	12/120	29,10€

NTE8 Temporizadores



Anchura	1 módulo 18mm
Contactos	1NA
Intensidad Nominal	5A/230Vca, 1A/30Vca-Vcc
Tipos	A: desconexión, B: conexión
Norma	UNE-EN60947-5



F1	Referencia	Retardo (seg)	Temporización a la...	Contactos	Tensión (V)	Embalaje	P.V.P.
	NTE8-10A/230	0.1~10	Desconexión	1NA	230Vca	12/120	29,50€
	NTE8-120A/230	10~120	Desconexión	1NA	230Vca	12/120	29,50€
	NTE8-480A/230	30~480	Desconexión	1NA	230Vca	12/120	29,50€
	NTE8-10B/230	0.1~10	Conexión	1NA	230Vca	12/120	29,50€
	NTE8-10B/24CA	0.1~10	Conexión	1NA	24Vca	12/120	29,50€
	NTE8-10B/24CC	0.1~10	Conexión	1NA	24Vcc	12/120	29,50€
	NTE8-120B/230	10~120	Conexión	1NA	230Vca	12/120	29,50€
	NTE8-120B/24CA	10~120	Conexión	1NA	24Vca	12/120	29,50€
	NTE8-120B/24CC	10~120	Conexión	1NA	24Vcc	12/120	29,50€
	NTE8-480B/230	30~480	Conexión	1NA	230Vca	12/120	29,50€
	NTE8-480B/24CA	30~480	Conexión	1NA	24Vca	12/120	29,50€
	NTE8-480B/24CC	30~480	Conexión	1NA	24Vcc	12/120	29,50€

Esquemas de conexión

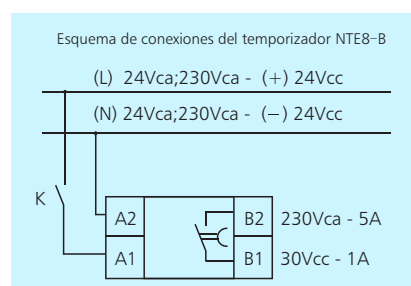
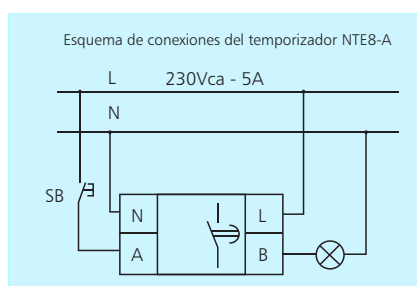



ND9
Pilotos simples

Tensión	6,12,24,110,230Vca/Vcc
Consumo lámpara	≤20mA
Vida del LED	30.000 horas
Norma	UNE-EN60947-5



F1	Referencia	Lámpara	Tensión	Color	Embalaje	P.V.P.
	ND9-PV6,3	LED	6.3Vca/Vcc	Verde	12/180	17,60€
	ND9-PV12	LED	12Vca/Vcc	Verde	12/180	17,60€
	NDP-PV24	LED	24Vca/Vcc	Verde	12/180	17,60€
	ND9-PV110	LED	110Vca/Vcc	Verde	12/180	17,60€
	ND9-PV230	LED	230Vca/Vcc	Verde	12/180	17,60€
	ND9-PR6,3	LED	6.3Vca/Vcc	Rojo	12/180	17,60€
	ND9-PR12	LED	12Vca/Vcc	Rojo	12/180	17,60€
	ND9-PR24	LED	24Vca/Vcc	Rojo	12/180	17,60€
	ND9-PR110	LED	110Vca/Vcc	Rojo	12/180	17,60€
	ND9-PR230	LED	230Vca/Vcc	Rojo	12/180	17,60€
	ND9-PA6,3	LED	6.3Vca/Vcc	Amarillo	12/180	17,60€
	ND9-PA12	LED	12Vca/Vcc	Amarillo	12/180	17,60€
	ND9-PA24	LED	24Vca/Vcc	Amarillo	12/180	17,60€
	ND9-PA110	LED	110Vca/Vcc	Amarillo	12/180	17,60€
	ND9-PA230	LED	230Vca/Vcc	Amarillo	12/180	17,60€
	ND9-PZ6,3	LED	6.3Vca/Vcc	Azul	12/180	17,60€
	ND9-PZ12	LED	12Vca/Vcc	Azul	12/180	17,60€
	ND9-PZ24	LED	24Vca/Vcc	Azul	12/180	17,60€
	ND9-PZ110	LED	110Vca/Vcc	Azul	12/180	17,60€
	ND9-PZ230	LED	230Vca/Vcc	Azul	12/180	17,60€
	ND9-PB6,3	LED	6.3Vca/Vcc	Blanco	12/180	17,60€
	ND9-PB12	LED	12Vca/Vcc	Blanco	12/180	17,60€
	ND9-PB24	LED	24Vca/Vcc	Blanco	12/180	17,60€
	ND9-PB110	LED	110Vca/Vcc	Blanco	12/180	17,60€
	ND9-PB230	LED	230Vca/Vcc	Blanco	12/180	17,60€



ND9
Pilotos dobles

Tensión	6, 12, 24, 48, 110, 230Vca
Consumo lámpara	≤20mA
Vida del LED	30.000 horas
Norma	UNE-EN60947-5



F1	Referencia	Lámpara	Tensión	Color	Embalaje	P.V.P.
	ND9-PVV6,3	LED	6.3Vca/Vcc	Verde+Verde	12/180	39,10€
	ND9-PVV12	LED	12Vca/Vcc	Verde+Verde	12/180	39,10€
	ND9-PVV24	LED	24Vca/Vcc	Verde+Verde	12/180	39,10€
	ND9-PVV110	LED	110Vca/Vcc	Verde+Verde	12/180	39,10€
	ND9-PVV230	LED	230Vca/Vcc	Verde+Verde	12/180	39,10€
	ND9-PVR6,3	LED	6.3Vca/Vcc	Verde+Rojo	12/180	39,10€
	ND9-PVR12	LED	12Vca/Vcc	Verde+Rojo	12/180	39,10€
	ND9-PVR24	LED	24Vca/Vcc	Verde+Rojo	12/180	39,10€
	ND9-PVR110	LED	110Vca/Vcc	Verde+Rojo	12/180	39,10€
	ND9-PVR230	LED	230Vca/Vcc	Verde+Rojo	12/180	39,10€
	ND9-PVA6,3	LED	6.3Vca/Vcc	Verde+Amarillo	12/180	39,10€
	ND9-PVA12	LED	12Vca/Vcc	Verde+Amarillo	12/180	39,10€
	ND9-PVA24	LED	24Vca/Vcc	Verde+Amarillo	12/180	39,10€
	ND9-PVA110	LED	110Vca/Vcc	Verde+Amarillo	12/180	39,10€
	ND9-PVA230	LED	230Vca/Vcc	Verde+Amarillo	12/180	39,10€
	ND9-PVZ6,3	LED	6.3Vca/Vcc	Verde+Azul	12/180	39,10€
	ND9-PVZ12	LED	12Vca/Vcc	Verde+Azul	12/180	39,10€
	ND9-PVZ24	LED	24Vca/Vcc	Verde+Azul	12/180	39,10€
	ND9-PVZ110	LED	110Vca/Vcc	Verde+Azul	12/180	39,10€
	ND9-PVZ230	LED	230Vca/Vcc	Verde+Azul	12/180	39,10€
	ND9-PVB6,3	LED	6.3Vca/Vcc	Verde+Blanco	12/180	39,10€
	ND9-PVB12	LED	12Vca/Vcc	Verde+Blanco	12/180	39,10€
	ND9-PVB24	LED	24Vca/Vcc	Verde+Blanco	12/180	39,10€
	ND9-PVB110	LED	110Vca/Vcc	Verde+Blanco	12/180	39,10€
	ND9-PVB230	LED	230Vca/Vcc	Verde+Blanco	12/180	39,10€
	ND9-PRR6,3	LED	6.3Vca/Vcc	Rojo+Rojo	12/180	39,10€
	ND9-PRR12	LED	12Vca/Vcc	Rojo+Rojo	12/180	39,10€
	ND9-PRR24	LED	24Vca/Vcc	Rojo+Rojo	12/180	39,10€
	ND9-PRR110	LED	110Vca/Vcc	Rojo+Rojo	12/180	39,10€
	ND9-PRR230	LED	230Vca/Vcc	Rojo+Rojo	12/180	39,10€
	ND9-PRA6,3	LED	6.3Vca/Vcc	Rojo+Amarillo	12/180	39,10€
	ND9-PRA12	LED	12Vca/Vcc	Rojo+Amarillo	12/180	39,10€
	ND9-PRA24	LED	24Vca/Vcc	Rojo+Amarillo	12/180	39,10€
	ND9-PRA110	LED	110Vca/Vcc	Rojo+Amarillo	12/180	39,10€
	ND9-PRA230	LED	230Vca/Vcc	Rojo+Amarillo	12/180	39,10€



F1	Referencia	Lámpara	Tensión	Color	Embalaje	P.V.P.
	ND9-PRZ6,3	LED	6.3Vca/Vcc	Rojo+Azul	12/180	39,10€
	ND9-PRZ12	LED	12Vca/Vcc	Rojo+Azul	12/180	39,10€
	ND9-PRZ24	LED	24Vca/Vcc	Rojo+Azul	12/180	39,10€
	ND9-PRZ110	LED	110Vca/Vcc	Rojo+Azul	12/180	39,10€
	ND9-PRZ230	LED	230Vca/Vcc	Rojo+Azul	12/180	39,10€
	ND9-PRB6,3	LED	6.3Vca/Vcc	Rojo+Blanco	12/180	39,10€
	ND9-PRB12	LED	12Vca/Vcc	Rojo+Blanco	12/180	39,10€
	ND9-PRB24	LED	24Vca/Vcc	Rojo+Blanco	12/180	39,10€
	ND9-PRB110	LED	110Vca/Vcc	Rojo+Blanco	12/180	39,10€
	ND9-PRB230	LED	230Vca/Vcc	Rojo+Blanco	12/180	39,10€
	ND9-PAA6,3	LED	6.3Vca/Vcc	Amarillo+Amarillo	12/180	39,10€
	ND9-PAA12	LED	12Vca/Vcc	Amarillo+Amarillo	12/180	39,10€
	ND9-PAA24	LED	24Vca/Vcc	Amarillo+Amarillo	12/180	39,10€
	ND9-PAA110	LED	110Vca/Vcc	Amarillo+Amarillo	12/180	39,10€
	ND9-PAA230	LED	230Vca/Vcc	Amarillo+Amarillo	12/180	39,10€
	ND9-PAZ6,3	LED	6.3Vca/Vcc	Amarillo+Azul	12/180	39,10€
	ND9-PAZ12	LED	12Vca/Vcc	Amarillo+Azul	12/180	39,10€
	ND9-PAZ24	LED	24Vca/Vcc	Amarillo+Azul	12/180	39,10€
	ND9-PAZ110	LED	110Vca/Vcc	Amarillo+Azul	12/180	39,10€
	ND9-PAZ230	LED	230Vca/Vcc	Amarillo+Azul	12/180	39,10€
	ND9-PAB6,3	LED	6.3Vca/Vcc	Amarillo+Blanco	12/180	39,10€
	ND9-PAB12	LED	12Vca/Vcc	Amarillo+Blanco	12/180	39,10€
	ND9-PAB24	LED	24Vca/Vcc	Amarillo+Blanco	12/180	39,10€
	ND9-PAB110	LED	110Vca/Vcc	Amarillo+Blanco	12/180	39,10€
	ND9-PAB230	LED	230Vca/Vcc	Amarillo+Blanco	12/180	39,10€
	ND9-PZZ6,3	LED	6.3Vca/Vcc	Azul+Azul	12/180	39,10€
	ND9-PZZ12	LED	12Vca/Vcc	Azul+Azul	12/180	39,10€
	ND9-PZZ24	LED	24Vca/Vcc	Azul+Azul	12/180	39,10€
	ND9-PZZ110	LED	110Vca/Vcc	Azul+Azul	12/180	39,10€
	ND9-PZZ230	LED	230Vca/Vcc	Azul+Azul	12/180	39,10€
	ND9-PZB6,3	LED	6.3Vca/Vcc	Azul+Blanco	12/180	39,10€
	ND9-PZB12	LED	12Vca/Vcc	Azul+Blanco	12/180	39,10€
	ND9-PZB24	LED	24Vca/Vcc	Azul+Blanco	12/180	39,10€
	ND9-PZB110	LED	110Vca/Vcc	Azul+Blanco	12/180	39,10€
	ND9-PZB230	LED	230Vca/Vcc	Azul+Blanco	12/180	39,10€
	ND9-PBB6,3	LED	6.3Vca/Vcc	Blanco+Blanco	12/180	39,10€
	ND9-PBB12	LED	12Vca/Vcc	Blanco+Blanco	12/180	39,10€
	ND9-PBB24	LED	24Vca/Vcc	Blanco+Blanco	12/180	39,10€
	ND9-PBB110	LED	110Vca/Vcc	Blanco+Blanco	12/180	39,10€
	ND9-PBB230	LED	230Vca/Vcc	Blanco+Blanco	12/180	39,10€



NP9 Pulsadores con piloto

Tensión	230Vca
Contactos	1NA
Intensidad nominal	6A
Consumo lámpara	20mA
Vida del LED	30.000 horas
Norma	UNE-EN61095



F1	Referencia	Lámpara	Número de contactos	Color Pulsador	Embalaje	P.V.P.
	NP9-PPR30-230	LED/230V	3NA, 0NC	Rojo	12/180	19,30€
	NP9-PPR21-230	LED/230V	2NA, 1NC	Rojo	12/180	19,30€
	NP9-PPR12-230	LED/230V	1NA, 2NC	Rojo	12/180	19,30€
	NP9-PPV30-230	LED/230V	3NA, 0NC	Verde	12/180	19,30€
	NP9-PPV21-230	LED/230V	2NA, 1NC	Verde	12/180	19,30€
	NP9-PPV12-230	LED/230V	1NA, 2NC	Verde	12/180	19,30€
	NP9-PPR30-110	LED/110V	3NA, 0NC	Rojo	12/180	19,30€
	NP9-PPR21-110	LED/110V	2NA, 1NC	Rojo	12/180	19,30€
	NP9-PPR12-110	LED/110V	1NA, 2NC	Rojo	12/180	19,30€
	NP9-PPV30-110	LED/110V	3NA, 0NC	Verde	12/180	19,30€
	NP9-PPV21-110	LED/110V	2NA, 1NC	Verde	12/180	19,30€
	NP9-PPV12-110	LED/110V	1NA, 2NC	Verde	12/180	19,30€
	NP9-PPR30-24	LED/24V	3NA, 0NC	Rojo	12/180	19,30€
	NP9-PPR21-24	LED/24V	2NA, 1NC	Rojo	12/180	19,30€
	NP9-PPR12-24	LED/24V	1NA, 2NC	Rojo	12/180	19,30€
	NP9-PPV30-24	LED/24V	3NA, 0NC	Verde	12/180	19,30€
	NP9-PPV21-24	LED/24V	2NA, 1NC	Verde	12/180	19,30€
	NP9-PPV12-24	LED/24V	1NA, 2NC	Verde	12/180	19,30€
	NP9-PPR30-12	LED/12V	3NA, 0NC	Rojo	12/180	19,30€
	NP9-PPR21-12	LED/12V	2NA, 1NC	Rojo	12/180	19,30€
	NP9-PPR12-12	LED/12V	1NA, 2NC	Rojo	12/180	19,30€
	NP9-PPV30-12	LED/12V	3NA, 0NC	Verde	12/180	19,30€
	NP9-PPV21-12	LED/12V	2NA, 1NC	Verde	12/180	19,30€
	NP9-PPV12-12	LED/12V	1NA, 2NC	Verde	12/180	19,30€
	NP9-PPR30-6,3	LED/6.3V	3NA, 0NC	Rojo	12/180	19,30€
	NP9-PPR21-6,3	LED/6.3V	2NA, 1NC	Rojo	12/180	19,30€
	NP9-PPR12-6,3	LED/6.3V	1NA, 2NC	Rojo	12/180	19,30€
	NP9-PPV30-6,3	LED/6.3V	3NA, 0NC	Verde	12/180	19,30€
	NP9-PPV21-6,3	LED/6.3V	2NA, 1NC	Verde	12/180	19,30€
	NP9-PPV12-6,3	LED/6.3V	1NA, 2NC	Verde	12/180	19,30€
	NP9-PR-30-230	-	3NA, 0NC	Rojo	12/180	19,30€
	NP9-PR21-230	-	2NA, 1NC	Rojo	12/180	19,30€
	NP9-PR12-230	-	1NA, 2NC	Rojo	12/180	19,30€
	NP9-PR22-230	-	2NA, 2NC	Rojo	12/180	19,30€
	NP9-PV30-230	-	3NA, 0NC	Verde	12/180	19,30€
	NP9-PV21-230	-	2NA, 1NC	Verde	12/180	19,30€
	NP9-PV12-230	-	1NA, 2NC	Verde	12/180	19,30€
	NP9-PV22-230	-	2NA, 2NC	Verde	12/180	19,30€

NCH8
Contadores



Tensión	24,230Vca
Intensidad nominal	20,25,40,63A
Categoría de utilización	AC1, AC7a, AC7b
Norma	UNE-EN61095



F1	Referencia	Corriente térmica	Contactos	Tensión Bobina	Módulos 18mm	Embalaje	P.V.P.
	NCH8-20/20-230	20A	2NO	230Vca	1	12/180	28,80€
	NCH8-20/20-24	20A	2NO	24Vca	1	12/180	28,80€
	NCH8-20/11-230	20A	1NO+1NC	230Vca	1	12/180	28,80€
	NCH8-20/11-24	20A	1NO+1NC	24Vca	1	12/180	28,80€
	NCH8-20/02-230	20A	2NC	230Vca	1	12/180	28,80€
	NCH8-20/02-24	20A	2NC	24Vca	1	12/180	28,80€
	NCH8-20/22-230	20A	2NO+2NC	230Vca	2	6/90	35,30€
	NCH8-20/22-24	20A	2NO+2NC	24Vca	2	6/90	35,30€
	NCH8-20/40-230	20A	4NO	230Vca	2	6/90	35,30€
	NCH8-20/40-24	20A	4NO	24Vca	2	6/90	35,30€
	NCH8-25/22-230	25A	2NO+2NC	230Vca	2	6/90	47,10€
	NCH8-25/22-24	25A	2NO+2NC	24Vca	2	6/90	47,10€
	NCH8-25/40-230	25A	4NO	230Vca	2	6/90	47,10€
	NCH8-25/40-24	25A	4NO	24Vca	2	6/90	47,10€
	NCH8-40/20-230	40A	2NO	230Vca	2	6/90	59,50€
	NCH8-40/20-24	40A	2NO	24Vca	2	6/90	59,50€
	NCH8-40/11-230	40A	1NO+1NC	230Vca	2	6/90	59,50€
	NCH8-40/11-24	40A	1NO+1NC	24Vca	2	6/90	59,50€
	NCH8-40/40-230	40A	4NO	230Vca	3	4/60	75,20€
	NCH8-40/40-24	40A	4NO	24Vca	3	4/60	75,20€
	NCH8-63/20-230	63A	2NO	230Vca	2	6/90	89,70€
	NCH8-63/20-24	63A	2NO	24Vca	2	6/90	89,70€
	NCH8-63/11-230	63A	1NO+1NC	230Vca	2	6/90	89,70€
	NCH8-63/11-24	63A	1NO+1NC	24Vca	2	6/90	89,70€
	NCH8-63/40-230	63A	4NO	230Vca	3	4/60	101,90€
	NCH8-63/40-24	63A	4NO	24Vca	3	4/60	101,90€



TC-S
Tomas de corriente



F3	Referencia	Características	Embalaje	P.V.P.
	TC-S	Toma de corriente 10/16A 250Vca - 36mm (2 módulos Din)	6	11,20€



KG10D Relojes/Programadores



F4	Referencia	Características	Dimens.	Embal.	P.V.P.
	KG10D-1Z	Reloj-programador - 1 circuito/10 maniobras ON/OFF 160/240Vca - Potencia: 3kW - In.: 15A (resistiva)	48mm	1	50,60€



JDM3/SC3L Contadores (montaje trescuadro)



F3	Referencia	Características	Dimensiones exteriores	Embal.	P.V.P.
	JDM3	Contador de impulsos - con botón de reset Totalización: 8 dígitos - Con batería de litio	53x48x24mm	1	60,80€
	SC3L	Cuenta horas - con botón de reset Totalización: 6½dígitos - Con batería de litio	53x48x24mm	1	44,70€



NX8 Cajas de Empotrar, de plástico, (IP30)



F3	Referencia	Módulos	Filas	Montaje	Dimensiones (mm) (Ancho*Alto*Fondo)	Embalaje	P.V.P.
	NX8-5	5	1	Empotrar	184x200x180	1	13,60€
	NX8-8	8	1	Empotrar	238x200x180	1	18,10€
	NX8-12	12	1	Empotrar	310x200x180	1	21,50€
	NX8-15	15	1	Empotrar	364x200x180	1	29,20€
	NX8-20	20	2	Empotrar	274x350x330	1	32,40€
	NX8-24	24	2	Empotrar	310x350x330	1	33,30€



NXW1 Cajas de Superficie, de plástico, (IP65)



F3	Referencia	Módulos	Filas	Montaje	Dimensiones (mm) (Ancho*Alto*Fondo)	Embalaje	P.V.P.
	NXW1-3	3	1	Superficie	100x72x108	1	23,60€
	NXW1-5	5	1	Superficie	136x125x108	1	29,30€



GUIA DIN

F1	Referencia	Longitud	Embalaje	P.V.P.
	GUIADIN35	1 mto.	1	6,30€

BB
Peines de conexión



Para interruptores automáticos y diferenciales



F4	Referencia	Tipo	Corriente (A)	Polos	Sección mm ²	Longitud	Embalaje	P.V.P.
	BB101-63	Pin	63	1	16	1 mto.	1	12,00€
	BB201-63	Pin	63	2	16	1 mto.	1	19,40€
	BB301-63	Pin	63	3	16	1 mto.	1	22,80€
	BB401-63	Pin	63	4	16	1 mto.	1	44,30€
	BB101-100	Pin	100	1	20	1 mto.	1	15,10€
	BB201-100	Pin	100	2	20	1 mto.	1	23,60€
	BB301-100	Pin	100	3	20	1 mto.	1	27,50€
	BB401-100	Pin	100	4	20	1 mto.	1	56,50€
	BB102-63	Horquilla	63	1	16	1 mto.	1	13,10€
	BB202-63	Horquilla	63	2	16	1 mto.	1	18,50€
	BB302-63	Horquilla	63	3	16	1 mto.	1	28,20€
	BB402-63	Horquilla	63	4	16	1 mto.	1	49,70€

Para aparatos combinados (interruptor+diferencial)



F4	Referencia	Tipo	Corriente (A)	Polos	Sección mm ²	Longitud	Embalaje	P.V.P.
	BB203-63	Pin	63	2	10	1 mto.	1	17,40€
	BB303-63	Pin	63	3	10	1 mto.	1	32,50€

Para aparatos de un polo + neutro en un módulo



F4	Referencia	Tipo	Corriente (A)	Polos	Sección mm ²	Longitud	Embalaje	P.V.P.
	BB403-63	Pin	63	1P+N	10	1 mto.	1	29,50€

Características de selección	1 fase						2, 3 y 4 fases			
	10	12	16	20	25	35	10	16	25	36
Alimentación por la parte final Sección (mm ²)										
Corriente máxima (A)	63	65	80	90	100	130	63	80	100	130
Alimentación por la mitad Corriente máxima (A)										
Corriente máxima (A)	100	110	130	150	180	220	100	130	180	220
	Dependiente de la sección									

Curva C para CA

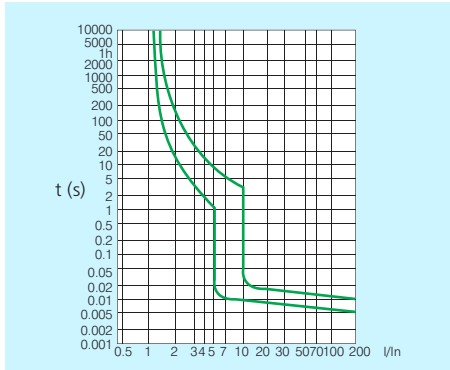

Curva ICP

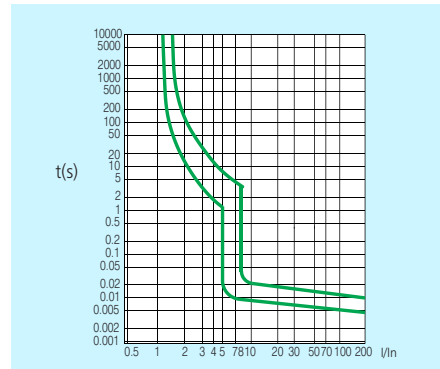

Curva B para CA

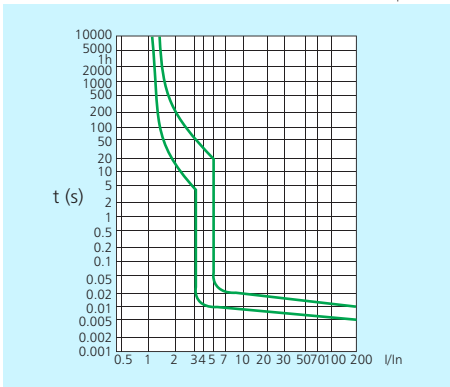

Curva D para CA

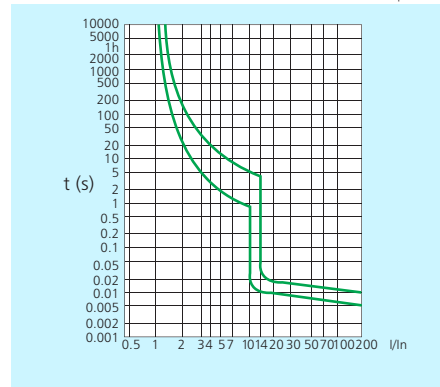

Curva 4-7 para CC

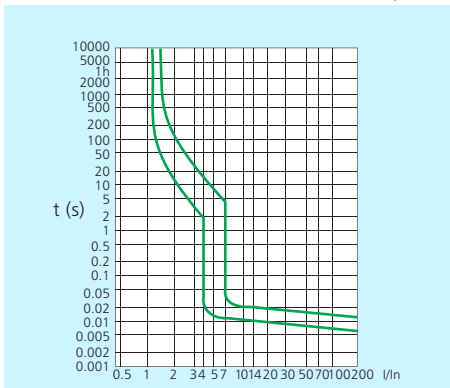

Curva 7-15 para CC

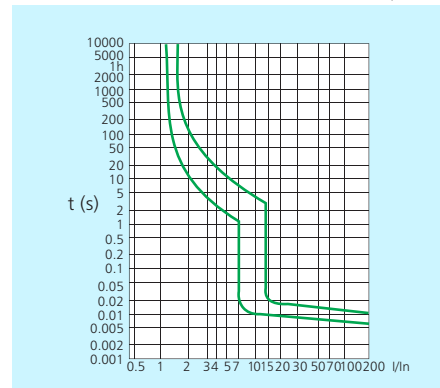

Curvas según UNE-EN 60947-2

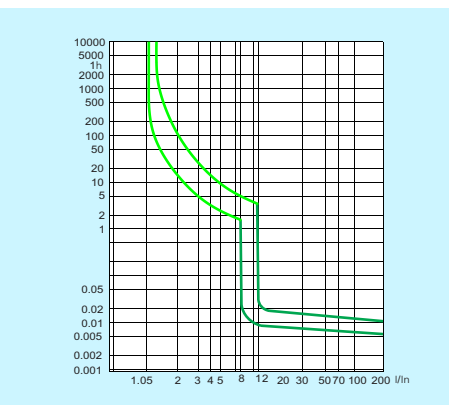

Corrección por temperatura

La corriente máxima permisible en un interruptor depende de la temperatura ambiente del lugar donde se instale. La temperatura ambiente es la temperatura existente en el interior de la caja o del cuadro de distribución en donde estén instalados los interruptores. La temperatura de referencia es 30°C.

-10°C	0°C	10°C	20°C	30°C	40°C	50°C	55°C	60°C
1.20	1.15	1.10	1.05	1.00	0.95	0.90	0.875	0.85

Ej.: Para una temperatura ambiente de 20°C la I_n del interruptor se verá incrementada en un 5% ($I_n \times 1.05$) y para una temperatura ambiente de 50°C la I_n se verá reducida en un 10% ($I_n \times 0.9$)

Si se instalan varios interruptores de funcionamiento simultáneo en una caja pequeña, el aumento de temperatura en el interior de la misma provocará una disminución de la corriente. En ese caso deberá asignarse a la corriente nominal (ya reducida si fuese necesario debido a la temperatura ambiente) un factor de disminución del 20% ($I_n \times 0,8$)

NM8
Interruptores automáticos
Electromecánicos

U.E	Noruega	Holanda	Rusia	Chequia	Ucrania

Polos	2,3,4P
Intensidad nominal	16A ~ 1250A
Ajuste térmico	0,8In ~ 1In
Montaje/Mando	Montaje fijo/Mando manual
Norma	UNE-EN60947-2

APARATOS TRIPOLARES (3P) - PODER DE CORTE ESTANDAR (Tipo S)



F1	Referencia	Regulaciones base	Poder de corte (Icu)	P.V.P.
	NM8-125S-3P-(*)A	(*) 16,20,25,32,40,50,63,80,100A	50kA	149,60€
	NM8-125S-3P-125A	125A	50kA	189,30€
	NM8-250S-3P-(*)A	(*) 100,125,160A	50kA	337,70€
	NM8-250S-3P-200A	200A	50kA	623,70€
	NM8-250S-3P-250A	250A	50kA	646,50€
	NM8-400S-3P-(*)A	250,315,350A	70kA	860,10€
	NM8-400S-3P-400A	400A	70kA	975,60€
	NM8-630S-3P-(*)A	250,315,350,400,500A	70kA	926,20€
	NM8-630S-3P-630A	630A	70kA	1.258,40€
	NM8-800S-3P-(*)A	630,700A	50kA	1.636,80€
	NM8-800S-3P-800A	800A	50kA	1.923,00€
	NM8-1250S-3P-(*)A	800,1000A	50kA	2.127,40€
	NM8-1250S-3P-1250A	1250A	50kA	2.435,40€

APARATOS TETRAPOLARES (4P) - PODER DE CORTE ESTANDAR (Tipo S)



F1	Referencia	Regulaciones base	Poder de corte (Icu)	P.V.P.
	NM8-125S-4P-(*)A	(*) 16,20,25,32,40,50,63,80,100A	50kA	219,70€
	NM8-125S-4P-125A	125A	50kA	258,20€
	NM8-250S-4P-(*)A	(*) 100,125,160A	50kA	527,40€
	NM8-250S-4P-200A	200A	50kA	742,80€
	NM8-250S-4P-250A	250A	50kA	802,10€
	NM8-400S-4P-(*)A	250,315,350A	70kA	1.136,20€
	NM8-400S-4P-400A	400A	70kA	1.365,30€
	NM8-630S-4P-(*)A	250,315,350,400,500A	70kA	1.497,90€
	NM8-630S-4P-630A	630A	70kA	1.685,30€
	NM8-800S-4P-(*)A	630,700A	50kA	1.865,30€
	NM8-800S-4P-800A	800A	50kA	2.249,60€
	NM8-1250S-4P-(*)A	800,1000A	50kA	2.945,00€
	NM8-1250S-4P-1250A	1250A	50kA	3.449,00€

Sustituir (*) por la corriente nominal deseada

APARATOS BIPOLARES (2P) - ALTO PODER DE CORTE (Tipo H)

F1	Referencia	Regulaciones base	Poder de corte (Icu)	P.V.P.
	NM8-125H-2P-(*)A	(*) 16,20,25,32,40,50,63,80,100A	100kA	219,50€
	NM8-125H-2P-125A	125A	100kA	258,20€
	NM8-250H-2P-(*)A	(*) 100,125,160A	100kA	413,70€
	NM8-250H-2P-200A	200A	100kA	568,50€
	NM8-250H-2P-250A	250A	100kA	637,50€

APARATOS TRIPOLARES (3P) - ALTO PODER DE CORTE (Tipo H)

F1	Referencia	Regulaciones base	Poder de corte (Icu)	P.V.P.
	NM8-125H-3P-(*)A	(*) 16,20,25,32,40,50,63,80,100A	100kA	230,10€
	NM8-125H-3P-125A	125A	100kA	309,40€
	NM8-250H-3P-(*)A	(*) 100,125,160A	100kA	507,00€
	NM8-250H-3P-200A	200A	100kA	702,70€
	NM8-250H-3P-250A	250A	100kA	724,70€
	NM8-400H-3P-(*)A	250,315,350A	100kA	1.118,90€
	NM8-400H-3P-400A	400A	100kA	1.258,30€
	NM8-630H-3P-(*)A	250,315,350,400,500A	100kA	1.261,40€
	NM8-630H-3P-630A	630A	100kA	1.493,20€
	NM8-800H-3P-(*)A	630,700A	70kA	1.740,10€
	NM8-800H-3P-800A	800A	70kA	2.016,40€
	NM8-1250H-3P-(*)A	800,1000A	70kA	2.589,80€
	NM8-1250H-3P-1250A	1250A	70kA	2.936,70€

APARATOS TETRAPOLARES (4P) - ALTO PODER DE CORTE (Tipo H)

F1	Referencia	Regulaciones base	Poder de corte (Icu)	P.V.P.
	NM8-125H-4P-(*)A	(*) 16,20,25,32,40,50,63,80,100A	100kA	303,60€
	NM8-125H-4P-125A	125A	100kA	394,90€
	NM8-250H-4P-(*)A	(*) 100,125,160A	100kA	686,20€
	NM8-250H-4P-200A	200A	100kA	850,00€
	NM8-250H-4P-250A	250A	100kA	947,50€
	NM8-400H-4P-(*)A	250,315,350A	100kA	1.403,10€
	NM8-400H-4P-400A	400A	100kA	1.529,70€

APARATOS TRIPOLARES (3P) - LIMITADORES (Tipo R)

F1	Referencia	Regulaciones base	Poder de corte (Icu)	P.V.P.
	NM8-125R-3P-(*)A	(*) 16,20,25,32,40,50,63,80,100A	150kA	376,90€
	NM8-125R-3P-125A	125A	150kA	418,20€
	NM8-250R-3P-(*)A	(*) 100,125,160A	150kA	716,70€
	NM8-250R-3P-200A	200A	150kA	971,70€
	NM8-250R-3P-250A	250A	150kA	1.109,60€
	NM8-400R-3P-(*)A	250,315,350A	150kA	1.799,40€
	NM8-400R-3P-400A	400A	150kA	1.944,90€
	NM8-630R-3P-(*)A	250,315,350,400,500A	150kA	2.440,20€
	NM8-630R-3P-630A	630A	150kA	2.763,40€

Sustituir (*) por la corriente nominal deseada

NM8S
Interruptores automáticos
Electrónicos

U.E	Noruega	Holanda	Rusia	Chequia	Ucrania

Polos	3,4P
Intensidad nominal	16A ~ 1250A
Ajuste térmico	0,4In ~ 1In
Montaje/Mando	Montaje fijo/Mando manual
Norma	UNE-EN60947-2

APARATOS TRIPOLARES (3P) - PODER DE CORTE ESTANDAR (Tipo S)



F1	Referencia	Regulaciones base	Poder de corte (Icu)	P.V.P.
	NM8S-125S-3P-(*)A	(*) 40,100A	50kA	538,40€
	NM8S-125S-3P-125A	125A	50kA	626,20€
	NM8S-250S-3P-(*)A	(*) 100,125,160A	50kA	796,20€
	NM8S-250S-3P-200A	200A	50kA	796,20€
	NM8S-250S-3P-250A	250A	50kA	909,80€
	NM8S-400S-3P-(*)A	250,315,350A	70kA	1.223,80€
	NM8S-400S-3P-400A	400A	70kA	1.346,30€
	NM8S-630S-3P-(*)A	250,315,350,400,500A	70kA	1.448,10€
	NM8S-630S-3P-630A	630A	70kA	1.595,90€
	NM8S-800S-3P-(*)A	630,700A	50kA	1.956,00€
	NM8S-800S-3P-800A	800A	50kA	2.438,10€
	NM8S-1250S-3P-(*)A	800,1000A	50kA	2.867,70€
	NM8S-1250S-3P-1250A	1250A	50kA	3.442,60€

APARATOS TETRAPOLARES (4P) - PODER DE CORTE ESTANDAR (Tipo S)



F1	Referencia	Regulaciones base	Poder de corte (Icu)	P.V.P.
	NM8S-125S-4P-(*)A	(*) 40,100A	50kA	623,80€
	NM8S-125S-4P-125A	125A	50kA	734,10€
	NM8S-250S-4P-(*)A	(*) 100,125,160A	50kA	1.024,40€
	NM8S-250S-4P-200A	200A	50kA	1.024,40€
	NM8S-250S-4P-250A	250A	50kA	1.202,50€
	NM8S-400S-4P-(*)A	250,315,350A	70kA	1.648,40€
	NM8S-400S-4P-400A	400A	70kA	1.866,20€
	NM8S-630S-4P-(*)A	250,315,350,400,500A	70kA	1.769,30€
	NM8S-630S-4P-630A	630A	70kA	1.995,30€
	NM8S-800S-4P-(*)A	630,700A	50kA	2.330,10€
	NM8S-800S-4P-800A	800A	50kA	2.751,50€
	NM8S-1250S-4P-(*)A	800,1000A	50kA	3.556,50€
	NM8S-1250S-4P-1250A	1250A	50kA	4.113,20€

Sustituir (*) por la corriente nominal deseada

APARATOS TRIPOLARES (3P) - ALTO PODER DE CORTE (Tipo H)



F1	Referencia	Regulaciones base	Poder de corte (Icu)	P.V.P.
	NM8S-125H-3P-(*)A	(*) 40,100A	100kA	645,30€
	NM8S-125H-3P-125A	125A	100kA	734,20€
	NM8S-250H-3P-(*)A	(*) 100,125,160A	100kA	818,50€
	NM8S-250H-3P-200A	200A	100kA	818,50€
	NM8S-250H-3P-250A	250A	100kA	936,20€
	NM8S-400H-3P-(*)A	250,315,350A	100kA	1.656,20€
	NM8S-400H-3P-400A	400A	100kA	1.830,20€
	NM8S-630H-3P-(*)A	250,315,350,400,500A	100kA	1.716,30€
	NM8S-630H-3P-630A	630A	100kA	1.915,20€
	NM8S-800H-3P-(*)A	630,700A	70kA	2.576,20€
	NM8S-800H-3P-800A	800A	70kA	2.769,00€
	NM8S-1250H-3P-(*)A	800,1000A	70kA	2.986,20€
	NM8S-1250H-3P-1250A	1250A	70kA	3.661,80€

APARATOS TETRAPOLARES (4P) - ALTO PODER DE CORTE (Tipo H)



F1	Referencia	Regulaciones base	Poder de corte (Icu)	P.V.P.
	NM8S-125H-4P-(*)A	(*) 40,100A	100kA	788,20€
	NM8S-125H-4P-125A	125A	100kA	883,50€
	NM8S-250H-4P-(*)A	(*) 100,125,160A	100kA	1.213,20€
	NM8S-250H-4P-200A	200A	100kA	1.213,20€
	NM8S-250H-4P-250A	250A	100kA	1.335,50€
	NM8S-400H-4P-(*)A	250,315,350A	100kA	2.113,40€
	NM8S-400H-4P-400A	400A	100kA	2.399,60€
	NM8S-630H-4P-(*)A	250,315,350,400,500A	100kA	2.159,40€
	NM8S-630H-4P-630A	630A	100kA	2.400,30€
	NM8S-800H-4P-(*)A	630,700A	70kA	2.834,30€
	NM8S-800H-4P-800A	800A	70kA	3.124,20€
	NM8S-1250H-4P-(*)A	800,1000A	70kA	3.836,10€
	NM8S-1250H-4P-1250A	1250A	70kA	4.335,60€

APARATOS TRIPOLARES (3P) - LIMITADORES (Tipo R)



F1	Referencia	Regulaciones base	Poder de corte (Icu)	P.V.P.
	NM8S-125R-3P-(*)A	(*) 40,100A	150kA	764,20€
	NM8S-125R-3P-125A	125A	150kA	830,10€
	NM8S-250R-3P-(*)A	(*) 100,125,160A	150kA	1.016,40€
	NM8S-250R-3P-200A	200A	150kA	1.016,40€
	NM8S-250R-3P-250A	250A	150kA	1.170,80€
	NM8S-400R-3P-(*)A	250,315,350A	150kA	2.319,40€
	NM8S-400R-3P-400A	400A	150kA	2.456,20€
	NM8S-630R-3P-(*)A	250,315,350,400,500A	150kA	2.676,20€
	NM8S-630R-3P-630A	630A	150kA	2.888,80€

Sustituir (*) por la corriente nominal deseada

NM8M Interruptores Sólo Magnéticos Electromecánicos



Polos	3,4P
Intensidad nominal	16A ~ 1250A
Ajuste térmico	Relés térmicos fijos
Montaje/Mando	Montaje fijo/Mando manual
Norma	UNE-EN60947-2

APARATOS TRIPOLARES (3P) - PODER DE CORTE ESTANDAR (Tipo S)



F1	Referencia	Regulaciones base	Poder de corte (Icu)	P.V.P.
	NM8M-125S-3P-(*)A	(*) 16,20,25,32,40,50,63,80,100A	50kA	146,40€
	NM8M-125S-3P-125A	125A	50kA	189,20€
	NM8M-250S-3P-(*)A	(*) 100,125,160A	50kA	571,50€
	NM8M-250S-3P-200A	200A	50kA	571,50€
	NM8M-250S-3P-250A	250A	50kA	606,80€
	NM8M-630S-3P-(*)A	250,315,350,400,500A	70kA	861,10€
	NM8M-630S-3P-630A	630A	70kA	1.141,50€
	NM8M-1250S-3P-(*)A	630,700,800,1000A	50kA	1.860,10€
	NM8M-1250S-3P-1250A	1250A	50kA	2.114,00€

APARATOS TETRAPOLARES (4P) - PODER DE CORTE ESTANDAR (Tipo S)



F1	Referencia	Regulaciones base	Poder de corte (Icu)	P.V.P.
	NM8M-125S-4P-(*)A	(*) 16,20,25,32,40,50,63,80,100A	50kA	210,10€
	NM8M-125S-4P-125A	125A	50kA	236,20€
	NM8M-250S-4P-(*)A	(*) 100,125,160A	50kA	655,20€
	NM8M-250S-4P-200A	200A	50kA	655,20€
	NM8M-250S-4P-250A	250A	50kA	710,30€
	NM8M-630S-4P-(*)A	250,315,350,400,500A	70kA	1.221,40€
	NM8M-630S-4P-630A	630A	70kA	1.428,80€
	NM8M-1250S-4P-(*)A	630,700,800,1000A	50kA	2.361,20€
	NM8M-1250S-4P-1250A	1250A	50kA	3.017,40€

Sustituir (*) por la corriente nominal deseada

APARATOS TRIPOLARES (3P) - ELEVADO PODER DE CORTE (Tipo H)

F1	Referencia	Regulaciones base	Poder de corte (Icu)	P.V.P.
	NM8M-125H-3P-(*)A	(*) 16,20,25,32,40,50,63,80,100A	100kA	146,40€
	NM8M-125H-3P-125A	125A	100kA	189,20€
	NM8M-250H-3P-(*)A	(*) 100,125,160A	100kA	621,20€
	NM8M-250H-3P-200A	200A	100kA	621,20€
	NM8M-250H-3P-250A	250A	100kA	670,50€
	NM8M-630H-3P-(*)A	250,315,350,400,500A	100kA	1.020,00€
	NM8M-630H-3P-630A	630A	100kA	1.255,70€
	NM8M-1250H-3P-(*)A	630,700,800,1000A	70kA	2.343,20€
	NM8M-1250H-3P-1250A	1250A	70kA	2.559,30€

APARATOS TETRAPOLARES (4P) - ELEVADO PODER DE CORTE (Tipo H)

F1	Referencia	Regulaciones base	Poder de corte (Icu)	P.V.P.
	NM8M-125H-4P-(*)A	(*) 16,20,25,32,40,50,63,80,100A	100kA	210,10€
	NM8M-125H-4P-125A	125A	100kA	236,20€
	NM8M-250H-4P-(*)A	(*) 100,125,160A	100kA	735,10€
	NM8M-250H-4P-200A	200A	100kA	735,10€
	NM8M-250H-4P-250A	250A	100kA	860,20€
	NM8M-630H-4P-(*)A	250,315,350,400,500A	100kA	1.536,30€
	NM8M-630H-4P-630A	630A	100kA	1.732,30€





APARATOS TRIPOLARES (3P) - LIMITADORES (Tipo R)

F1	Referencia	Regulaciones base	Poder de corte (Icu)	P.V.P.
	NM8M-125R-3P-(*)A	(*) 16,20,25,32,40,50,63,80,100A	125kA	286,10€
	NM8M-125R-3P-125A	125A	125kA	320,30€
	NM8M-250R-3P-(*)A	(*) 100,125,160A	125kA	836,00€
	NM8M-250R-3P-200A	200A	125kA	836,00€
	NM8M-250R-3P-250A	250A	125kA	963,30€
	NM8M-630R-3P-(*)A	250,315,350,400,500A	125kA	1.070,30€
	NM8M-630R-3P-630A	630A	125kA	1.387,50€





Sustituir (*) por la corriente nominal deseada

NM8 Accesorios

ACCESORIOS ELÉCTRICOS

F1	Referencia	Descripción	Para aparatos	P.V.P.
	125692	Bobina de emisión de tensión 220/230Vca	NM8-125	53,30€
	125695	Bobina de emisión de tensión 380/400Vca		
	125698	Bobina de emisión de tensión 24Vcc		
	125693	Bobina de emisión de tensión 220/230Vca	NM8-250,400,630 NM8S-125 NM8S-250,400,630	60,40€
	125696	Bobina de emisión de tensión 380/400Vca		
	125699	Bobina de emisión de tensión 24Vcc		
	125694	Bobina de emisión de tensión 220/230Vca	NM8-800,1250 NM8S-800,1250	61,30€
	125697	Bobina de emisión de tensión 380/400Vca		
	125702	Bobina de mínima tensión 220/230Vca		
	125705	Bobina de mínima tensión 380/400Vca	NM8-125	80,80€
	125703	Bobina de mínima tensión 220/230Vca	NM8-250,400,630 NM8S-125 NM8S-250,400,630	91,40€
	125706	Bobina de mínima tensión 380/400Vca		
	125704	Bobina de mínima tensión 220/230Vca	NM8-800,1250 NM8S-800,1250	111,50€
	125707	Bobina de mínima tensión 380/400Vca		
	125688/(*)	Mando motorizado Sustituir (*) por: 24Vcc, 110Vca/cc, 230Vca, 400Vca		
	125689/(*)	Mando motorizado Sustituir (*) por: 24Vcc, 110Vca/cc, 230Vca, 400Vca	NM8-250 NM8S-125,250	553,70€
	125690/(*)	Mando motorizado Sustituir (*) por: 24Vcc, 110Vca/cc, 230Vca, 400Vca		
	125691/(*)	Mando motorizado Sustituir (*) por: 230Vca, 400Vca	NM8-400,630 NM8S-400,630	720,40€
	125708	Contacto auxiliar 1NA/NC - lado izquierdo	Todos los modelos	41,40€
	125719	Contacto auxiliar 1NA/NC - central		41,40€
	125720	Contacto auxiliar 1NA/NC - lado derecho		41,40€
	125709	Contacto de alarma 1NA/NC		41,40€

MANDOS ROTATIVOS

F1	Referencia	Descripción	Para aparatos	P.V.P.
	125655	Mando rotativo con eje prolongado - 3P, 4P	NM8-125	86,43€
	125656	Mando rotativo con eje prolongado - 3P, 4P	NM8-125S NM8-250, NM8S-250	92,13€
	125657	Mando rotativo con eje prolongado - 3P, 4P	NM8-400,630 NM8S-400,630	104,23€
	125659	Mando rotativo directo - 3P, 4P	NM8-125	69,03€
	125660	Mando rotativo directo - 3P, 4P	NM8-250	75,63€
	125661	Mando rotativo directo - 3P, 4P	NM8-400,630	92,93€
	125722	Mando rotativo directo - 3P, 4P	NM8S-125,250	69,30€
	125723	Mando rotativo directo - 3P, 4P	NM8S-400,630	93,20€
	125662	Mando rotativo con eje prolongado - 3P, 4P	NM8-125	94,23€
	125663	Mando rotativo con eje prolongado - 3P, 4P	NM8-250	97,43€
	125664	Mando rotativo con eje prolongado - 3P, 4P	NM8-400,630	112,13€
	125724	Mando rotativo con eje prolongado - 3P, 4P	NM8S-125,250	94,50€
	125725	Mando rotativo con eje prolongado - 3P, 4P	NM8S-400,630	111,40€

NM8 Accesorios

CONEXIONES EXTERNAS



F1	Referencia	Descripción	Para aparatos	P.V.P.
	125601	Pletinas frontales - 2P	NM8-125	19,13€
	125603	Pletinas frontales - 3P		26,13€
	125608	Pletinas frontales - 4P		36,13€
	125602	Pletinas frontales - 2P	NM8S-125 NM8-250, NM8S-250	23,43€
	125604	Pletinas frontales - 3P		35,93€
	125609	Pletinas frontales - 4P		48,03€
	125605	Pletinas frontales - 3P	NM8-400,630 NM8S-400,630	66,23€
	125610	Pletinas frontales - 4P		86,33€
	125606	Pletinas frontales - 3P	NM8-800,1250 NM8S-800,1250	85,83€
	125611	Pletinas frontales - 4P		111,23€
	125613	Pletinas de conexión posterior - 2P	NM8-125	40,33€
	125615	Pletinas de conexión posterior - 3P		51,23€
	125618	Pletinas de conexión posterior - 4P		66,43€
	125614	Pletinas de conexión posterior - 2P	NM8S-125 NM8-250, NM8S-250	55,10€
	125616	Pletinas de conexión posterior - 3P		66,33€
	125619	Pletinas de conexión posterior - 4P		86,63€
	125617	Pletinas de conexión posterior - 3P	NM8-400,630 NM8S-400,630	80,83€
	125620	Pletinas de conexión posterior - 4P		104,43€
	125621	Base enchufable - 3P	NM8-125	116,23€
	125624	Base enchufable - 4P		149,13€
	125622	Base enchufable - 3P	NM8S-125 NM8-250, NM8S-250	145,83€
	125625	Base enchufable - 4P		177,43€
	125623	Base enchufable - 3P		299,23€
	125626	Base enchufable - 4P	NM8S-400,630 NM8S-400,630	358,73€
	125627	Adaptador a carril Din - 3P	NM8-125	24,53€
	125629	Adaptador a carril Din - 4P		27,93€
	125628	Adaptador a carril Din - 3P		NM8S-125
	125630	Adaptador a carril Din - 4P	NM8-250, NM8S-250	38,23€

TERMINALES DE CONEXIÓN





F1	Referencia	Para interruptores	Cables admisibles	Aberturas (max.)	P.V.P.
	125631	NM8-125, NM8S-125	1x95mm ²	95mm ²	15,99€
	125632	NM8-250, NM8S-250	1x120mm ²	150mm ²	15,99€
	125633	NM8-250, NM8S-250	2x150mm ²	240mm ²	15,99€
	125634	NM8-250, NM8S-250	1x240mm ²	240mm ²	15,99€
	125635	NM8-400,630, NM8S-400,630	4x95mm ²	150mm ²	31,10€
	125636	NM8-400,630, NM8S-400,630	2x240mm ²	240mm ²	33,47€
	125637	NM8-400,630, NM8S-400,630	1x240mm ²	240mm ²	33,47€
	125638	NM8-400,630, NM8S-400,630	1x240mm ²	240mm ²	33,47€
	125639	NM8-800,1250, NM8S-800,1250	3x240mm ²	95mm ²	51,80€
	125640	NM8-800,1250, NM8S-800,1250	4x240mm ²	240mm ²	51,80€



Nota: El precio de los terminales de conexión es por unidad de terminal

NM8 Accesorios

CUBREBORNES

F1	Referencia	Descripción	Para aparatos	P.V.P.
	125674	Cubrebornes alto - 3P	NM8-125	27,10€
	125678	Cubrebornes alto - 4P		32,10€
	125675	Cubrebornes alto - 3P	NM8S-125,NM8-250 NM8S-125,250	32,10€
	125679	Cubrebornes alto - 4P		39,40€
	125676	Cubrebornes alto - 3P	NM8-400,630 NM8S-400,630	36,70€
	125680	Cubrebornes alto - 4P		43,20€
	125677	Cubrebornes alto - 3P	NM8-800,1250 NM8S-800,1250	58,50€
		125681	Cubrebornes bajo - 3P	NM8-125
125685		Cubrebornes bajo - 4P	29,20€	
125682		Cubrebornes bajo - 3P	NM8S-125,NM8-250 NM8S-125,250	27,20€
125686		Cubrebornes bajo - 4P		30,80€
125683		Cubrebornes bajo - 3P	NM8-400,630 NM8S-400,630	31,00€
125687		Cubrebornes bajo - 4P		35,10€
125684		Cubrebornes bajo - 3P	NM8-800,1250 NM8S-800,1250	55,30€

BLOQUEOS

F1	Referencia	Descripción	Para aparatos	P.V.P.
	125671	Bloqueo por candados	NM8-125	21,10€
	125672	Bloqueo por candados	NM8S-125,NM8-250 NM8S-125,250	25,50€
	125673	Bloqueo por candados	NM8-400,630 NM8S-400,630	32,10€
	125716	Bloqueo mecánico tipo pasador	NM8-125	84,50€
	125717	Bloqueo mecánico tipo pasador	NM8S-125,NM8-250 NM8S-125,250	104,80€
	125718	Bloqueo mecánico tipo pasador	NM8-400,630 NM8S-400,630	136,70€
	125710	Bloqueo mecánico posterior, tipo pasador - 3P	NM8-125	64,40€
	125713	Bloqueo mecánico posterior, tipo pasador - 4P		84,50€
	125711	Bloqueo mecánico posterior, tipo pasador - 3P	NM8S-125,NM8-250 NM8S-125,250	85,10€
	125714	Bloqueo mecánico posterior, tipo pasador - 4P		104,80€
	125712	Bloqueo mecánico posterior, tipo pasador - 3P	NM8-400,630 NM8S-400,630	114,40€
	125715	Bloqueo mecánico posterior, tipo pasador - 4P		139,00€

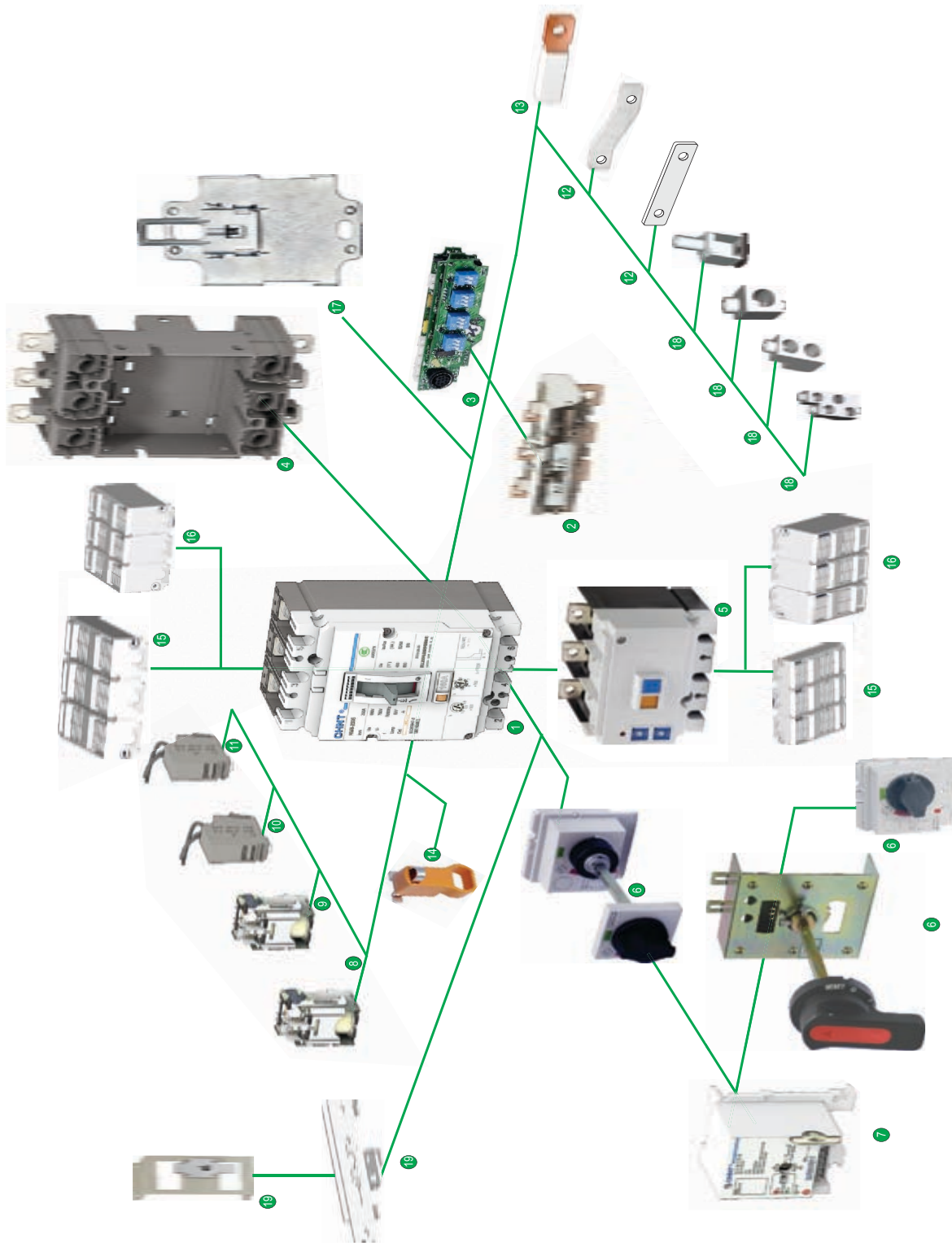

- 1 Cuerpo
- 2 Bloque relés magnetotérmicos
- 3 Bloque relés electrónicos
- 4 Base enchufable
- 5 Módulo protección diferencial
- 6 Mando relativo manual
- 7 Mando motor
- 8 Bobina de mínima tensión
- 9 Bobina emisión de corriente
- 10 Contacto de alarma
- 11 Contacto auxiliar
- 12 Pielinas de conexión frontal
- 13 Pielinas de conexión posterior
- 14 Bloqueo por candado
- 15 Cubrebornes bajo
- 16 Cubrebornes alto
- 17 Adaptador a guía Din
- 18 Terminales de jaula
- 19 Bloqueo mecánico

NM1
Interruptores automáticos
Electromecánicos

U.E	Holanda	Chequia	Ucrania	Rusia	Sudáfrica

Polos	3,4P
Intensidad nominal	16A ~ 1250A
Relé térmico	Fijo
Montaje/Mando	Montaje fijo/Mando manual
Norma	UNE-EN60947-2

APARATOS TRIPOLARES (3P)



F1	Referencia	Regulaciones base	Poder de corte (Icu)	P.V.P.
	NM1-63H-3P-(*)A	(*) 10,16,20,25,32,40,50,63A	35kA	112,70€
	NM1-100H-3P-(*)A	(*) 16,20,25,32,40,50,63,80A	50kA	121,00€
	NM1-100H-3P-100A	100A	50kA	155,90€
	NM1-225H-3P-125A	125A	50kA	273,90€
	NM1-225H-3P-160A	160A	50kA	279,90€
	NM1-225H-3P-200A	200A	50kA	327,10€
	NM1-225H-3P-225A	225A	50kA	390,20€
	NM1-400S-3P-250A	250A	35kA	712,70€
	NM1-400S-3P-(*)A	(*) 315,350A	35kA	743,90€
	NM1-400S-3P-400A	400A	35kA	771,00€
	NM1-630S-3P-500A	500A	35kA	1.134,40€
	NM1-630S-3P-630A	630A	35kA	1.192,80€
	NM1-800H-3P-700A	700A	60kA	2.114,60€
	NM1-800H-3P-800A	800A	60kA	2.314,10€
	NM1-1250H-3P-1000A	1000A	65kA	3.048,20€
	NM1-1250H-3P-1250A	1250A	65kA	3.678,80€

APARATOS TETRAPOLARES (4P)



F1	Referencia	Regulaciones base	Poder de corte (Icu)	P.V.P.
	NM1-63H-4P-(*)A	(*) 10,16,20,25,32,40,50,63A	35kA	141,10€
	NM1-100H-4P-(*)A	(*) 16,20,25,32,40,50,63,80A	25kA	172,50€
	NM1-100H-4P-100A	100A	25kA	198,10€
	NM1-225H-4P-125A	125A	50kA	336,60€
	NM1-225H-4P-160A	160A	50kA	344,90€
	NM1-225H-4P-200A	200A	50kA	392,90€
	NM1-225H-4P-225A	225A	50kA	447,70€
	NM1-400S-4P-250A	250A	35kA	773,30€
	NM1-400S-4P-(*)A	(*) 315,350A	35kA	812,40€
	NM1-400S-4P-400A	400A	35kA	834,00€
	NM1-630S-4P-500A	500A	35kA	1.372,90€
	NM1-630S-4P-630A	630A	35kA	1.431,40€

Sustituir (*) por la corriente nominal deseada

BLOQUEOS MECÁNICOS



F1	Referencia	Descripción	Para aparatos	P.V.P.
	125120	Bloqueo mecánico tipo pasador - 3P	NM1-63	17,80€
	125121	Bloqueo mecánico tipo pasador - 3P	NM1-100H	36,20€
	125122	Bloqueo mecánico tipo pasador - 3P	NM1-225H	39,60€
	125123	Bloqueo mecánico tipo pasador - 3P	NM1-400S	48,90€
	125124	Bloqueo mecánico tipo pasador - 3P	NM1-630S	64,10€

NM1 Accesorios

MANDOS ROTATIVOS



F1	Referencia	Descripción	Para aparatos	P.V.P.
	125083	Mando rotativo con eje prolongado - 3P, 4P	NM1-63H	26,60€
	125084	Mando rotativo con eje prolongado - 3P	NM1-100H	49,20€
	125085	Mando rotativo con eje prolongado - 4P	NM1-100H	49,20€
	125086	Mando rotativo con eje prolongado - 3P, 4P	NM1-225H	56,40€
	125087	Mando rotativo con eje prolongado - 3P	NM1-400S	68,80€
	125088	Mando rotativo con eje prolongado - 4P	NM1-400S	68,80€
	125090	Mando rotativo con eje prolongado - 3P	NM1-630S	76,10€
	125091	Mando rotativo con eje prolongado - 4P	NM1-630S	76,10€
	125092	Mando rotativo con eje prolongado - 3P	NM1-800H	79,10€
	125093	Mando rotativo con eje prolongado - 4P	NM1-800H	79,10€
	125094	Mando rotativo con eje prolongado - 3P	NM1-1250H	86,00€
	125095	Mando rotativo con eje prolongado - 4P	NM1-1250H	86,00€

TERMINALES DE CONEXIÓN



F1	Referencia	Descripción	Para aparatos	P.V.P.
	125125	Terminales de conexión tipo Jaula - 3P (3 piezas)	NM1-100	21,00€
	125131	Terminales de conexión tipo Jaula - 4P (4 piezas)	NM1-100	25,00€
	125126	Terminales de conexión tipo Jaula - 3P (3 piezas)	NM1-225	23,00€
	125132	Terminales de conexión tipo Jaula - 4P (4 piezas)	NM1-225	27,00€
	125127	Terminales de conexión tipo Jaula - 3P (3 piezas)	NM1-400	35,00€
	125133	Terminales de conexión tipo Jaula - 4P (4 piezas)	NM1-400	40,00€
	125128	Terminales de conexión tipo Jaula - 3P (3 piezas)	NM1-630	67,00€
	125134	Terminales de conexión tipo Jaula - 4P (4 piezas)	NM1-630	79,00€
	125129	Terminales de conexión tipo Jaula - 3P (3 piezas)	NM1-800	89,00€
	125135	Terminales de conexión tipo Jaula - 4P (4 piezas)	NM1-800	101,00€
	125130	Terminales de conexión tipo Jaula - 3P (3 piezas)	NM1-1250	131,00€
	125136	Terminales de conexión tipo Jaula - 4P (4 piezas)	NM1-1250	153,00€

CONEXIONES EXTERNAS



F1	Referencia	Descripción	Para aparatos	P.V.P.
	125137	Pletinas frontales - 3P (3 piezas)	NM1-63	21,20€
	125143	Pletinas frontales - 4P (4 piezas)	NM1-63	23,20€
	125138	Pletinas frontales - 3P (3 piezas)	NM1-100	35,40€
	125144	Pletinas frontales - 4P (4 piezas)	NM1-100	41,40€
	125139	Pletinas frontales - 3P (3 piezas)	NM1-225	54,00€
	125145	Pletinas frontales - 4P (4 piezas)	NM1-225	64,00€
	125140	Pletinas frontales - 3P (3 piezas)	NM1-400	78,30€
	125146	Pletinas frontales - 4P (4 piezas)	NM1-400	89,70€
	125141	Pletinas frontales - 3P (3 piezas)	NM1-630S	101,20€
	125147	Pletinas frontales - 4P (4 piezas)	NM1-630S	126,30€

CUBREBORNES



F1	Referencia	Descripción	Para aparatos	P.V.P.
	125149	Cubrebornes bajo - 3P (1 pieza)	NM1-100H	6,00€
	125152	Cubrebornes bajo - 3P (1 pieza)	NM1-225H	6,50€
	125154	Cubrebornes bajo - 3P (1 pieza)	NM1-400S	8,70€
	125157	Cubrebornes bajo - 3P (1 pieza)	NM1-630S	9,80€
	125160	Cubrebornes bajo - 3P (1 pieza)	NM1-800H	10,80€
	125162	Cubrebornes bajo - 3P (1 pieza)	NM1-1250H	12,50€

NA1
Interruptores automáticos
En bastidor

CE	KEMA UR	CCC	005	PG	RCC
U.E.	Holanda	Chequia	Ucrania	Rusia	Sudáfrica

Polos	3,4P
Intensidad nominal	630A ~ 6300A
Ajuste térmico	0,4In ~ 1In
Tipo de relé	Electrónico
Norma	UNE-EN60947-2

APARATOS TRIPOLARES (3P) - MONTAJE FIJO - MANDO MANUAL



F4	Referencia	Regulaciones base	Poder de corte (Icu)	P.V.P.
	NA1-2000/630-3P-FM	252~630A	80kA	3.348,00€
	NA1-2000/800-3P-FM	320~800A	80kA	3.621,00€
	NA1-2000/1000-3P-FM	400~1000A	80kA	3.714,00€
	NA1-2000/1250-3P-FM	500~1250A	80kA	3.864,00€
	NA1-2000/1600-3P-FM	640~1600A	80kA	4.309,00€
	NA1-2000/2000-3P-FM	800~2000A	80kA	5.509,00€
	NA1-3200/2000-3P-FM	800~2000A	80kA	6.742,00€
	NA1-3200/2500-3P-FM	1000~2500A	80kA	6.964,00€
	NA1-3200/3200-3P-FM	1280~3200A	80kA	10.170,00€
	NA1-4000/3200-3P-FM	1280~3200A	80kA	11.876,00€
	NA1-4000/4000-3P-FM	1600~4000A	80kA	13.587,00€

APARATOS TETRAPOLARES (4P) - MONTAJE FIJO - MANDO MANUAL



F4	Referencia	Regulaciones base	Poder de corte (Icu)	P.V.P.
	NA1-2000/630-4P-FM	252~630A	80kA	3.898,00€
	NA1-2000/800-4P-FM	320~800A	80kA	4.195,00€
	NA1-2000/1000-4P-FM	400~1000A	80kA	4.486,00€
	NA1-2000/1250-4P-FM	500~1250A	80kA	4.570,00€
	NA1-2000/1600-4P-FM	640~1600A	80kA	5.120,00€
	NA1-2000/2000-4P-FM	800~2000A	80kA	6.675,00€
	NA1-3200/2000-4P-FM	800~2000A	80kA	8.098,00€
	NA1-3200/2500-4P-FM	1000~2500A	80kA	8.409,00€
	NA1-3200/3200-4P-FM	1280~3200A	80kA	12.455,00€

Nota: Los interruptores NA1 se suministran, de serie, con la bobina de mínima tensión incluida.

APARATOS TRIPOLARES (3P) - MONTAJE EXTRAÍBLE - MANDO MANUAL

F4	Referencia	Regulaciones base	Poder de corte (Icu)	P.V.P.
	NA1-2000/630-3P-EM	252~630A	80kA	4.380,00€
	NA1-2000/800-3P-EM	320~800A	80kA	4.682,00€
	NA1-2000/1000-3P-EM	400~1000A	80kA	5.076,00€
	NA1-2000/1250-3P-EM	500~1250A	80kA	5.159,00€
	NA1-2000/1600-3P-EM	640~1600A	80kA	5.920,00€
	NA1-2000/2000-3P-EM	800~2000A	80kA	8.897,00€
	NA1-3200/2000-3P-EM	800~2000A	80kA	9.015,00€
	NA1-3200/2500-3P-EM	1000~2500A	80kA	9.386,00€
	NA1-3200/3200-3P-EM	1280~3200A	80kA	13.857,00€
	NA1-4000/3200-3P-EM	1280~3200	80kA	17.490,00€
	NA1-4000/4000-3P-EM	1600~4000A	80kA	19.758,00€
	NA1-6300/4000-3P-EM	1600~4000A	120kA	25.223,00€
	NA1-6300/5000-3P-EM	2000~5000A	120kA	26.485,00€
	NA1-6300/6300-3P-EM	2520~6300A	120kA	33.459,00€

APARATOS TETRAPOLARES (4P) - MONTAJE EXTRAÍBLE - MANDO MANUAL

F4	Referencia	Regulaciones base	Poder de corte (Icu)	P.V.P.
	NA1-2000/630-4P-EM	252~630A	80kA	5.276,00€
	NA1-2000/800-4P-EM	320~800A	80kA	5.510,00€
	NA1-2000/1000-4P-EM	400~1000A	80kA	6.186,00€
	NA1-2000/1250-4P-EM	500~1250A	80kA	6.315,00€
	NA1-2000/1600-4P-EM	640~1600A	80kA	7.192,00€
	NA1-2000/2000-4P-EM	800~2000A	80kA	9.186,00€
	NA1-3200/2000-4P-EM	800~2000A	80kA	10.423,00€
	NA1-3200/2500-4P-EM	1000~2500A	80kA	10.979,00€
	NA1-3200/3200-4P-EM	1280~3200A	80kA	15.662,00€
	NA1-4000/3200-4P-EM	1280~3200	80kA	23.112,00€
	NA1-4000/4000-4P-EM	1600~4000A	80kA	23.390,00€
	NA1-6300/4000-4P-EM	1600~4000A	120kA	28.668,00€
	NA1-6300/5000-4P-EM	2000~5000A	120kA	28.861,00€



Nota: Los interruptores NA1 se suministran, de serie, con la bobina de mínima tensión incluida.

NA1 Accesorios

ACCESORIOS ELÉCTRICOS

F4	Referencia	Descripción	P.V.P.
	NA1-SHT230VCA	Bobina de emisión de tensión - 230Vca	112,10€
	NA1-SHT400VCA	Bobina de emisión de tensión - 400Vca	112,10€
	NA1-SHT110VCC	Bobina de emisión de tensión - 110Vcc	126,90€
	NA1-SHT220VCC	Bobina de emisión de tensión - 220Vcc	126,90€
	NA1-UVT230VCA	Bobina de mínima tensión, instantánea - 230Vca	277,70€
	NA1-UVT400VCA	Bobina de mínima tensión, instantánea - 400Vca	277,70€
	NA1-UVT110VCC	Bobina de mínima tensión, instantánea - 110Vca	321,30€
	NA1-UVT220VCC	Bobina de mínima tensión, instantánea - 220Vca	321,30€
	NA1-UVTR230VCA-(*)	Bobina de mínima tensión, retardada (*) - 230Vca	299,90€
	NA1-UVTR300VCA-(*)	Bobina de mínima tensión, retardada (*) - 400Vca	299,90€
	NA1-UVTR110VCC-(*)	Bobina de mínima tensión, retardada (*) - 110Vca	333,30€
	NA1-UVTR220VCC-(*)	Bobina de mínima tensión, retardada (*) - 220Vca	333,30€
	NA1-MOT230VCA	Mando motorizado - 230Vca	725,50€
	NA1-MOT400VCA	Mando motorizado - 400Vca	725,50€
	NA1-MOT220VCC	Mando motorizado - 220Vcc	786,40€
	NA1-CC230VCA	Bobina de cierre a distancia - 230Vca	133,30€
	NA1-CC400VCA	Bobina de cierre a distancia - 400Vca	133,30€
	NA1-CC110VCC	Bobina de cierre a distancia - 110Vcc	145,80€
	NA1-CC220VCC	Bobina de cierre a distancia - 220Vcc	145,80€
	NA1-AC35	Bloque de contactos auxiliares 3NA+5NC	78,80€
	NA1-AC53	Bloque de contactos auxiliares 5NA+3NC	78,80€
	NA1-AC62	Bloque de contactos auxiliares 6NA+2NC	78,80€
	NA1-AC26	Bloque de contactos auxiliares 2NA+6NC	78,80€
	NA1-RS485	Relé electrónico con controlador de comunicaciones	consultar

(*) Indicar retardo: 0,5, 1, 2 o 3 seg.

ACCESORIOS MECÁNICOS

F4	Referencia	Descripción	P.V.P.
	NA1-KEYLOCK	Bloqueo, por llave, del botón de cierre del interruptor	81,10€
	NA1-PADLOCK	Bloqueo, por candado, del interruptor	69,90€
	NA1-CABLOCK	Enclavamiento mecánico por cable entre 2 interruptores - longitud cable: 2 mts.	69,90€
	NA1-MECLOCK	Enclavamiento mecánico por varillas, vertical, entre 3 interruptores	225,50€

NA1 Interruptores de corte al aire

- 1 Interruptor extraíble
- 2 Interruptor fijo
- 3 Relé electrónico
- 4 Mecanismo de accionamiento
- 5 Bloque de contactos auxiliares
- 6 Dispositivo de enclavamiento por llave
- 7 Cámara apagachispas
- 8 Bloque de contactos
- 9 Enclavamiento mecánico por cables
- 10 Enclavamiento mecánico por varillas
- 11 Bobina de cierre
- 12 Bobina de mínima tensión
- 13 Bobina de emisión de corriente
- 14 Motor de accionamiento
- 15 Palanca de extracción
- 16 Placa de montaje fijo

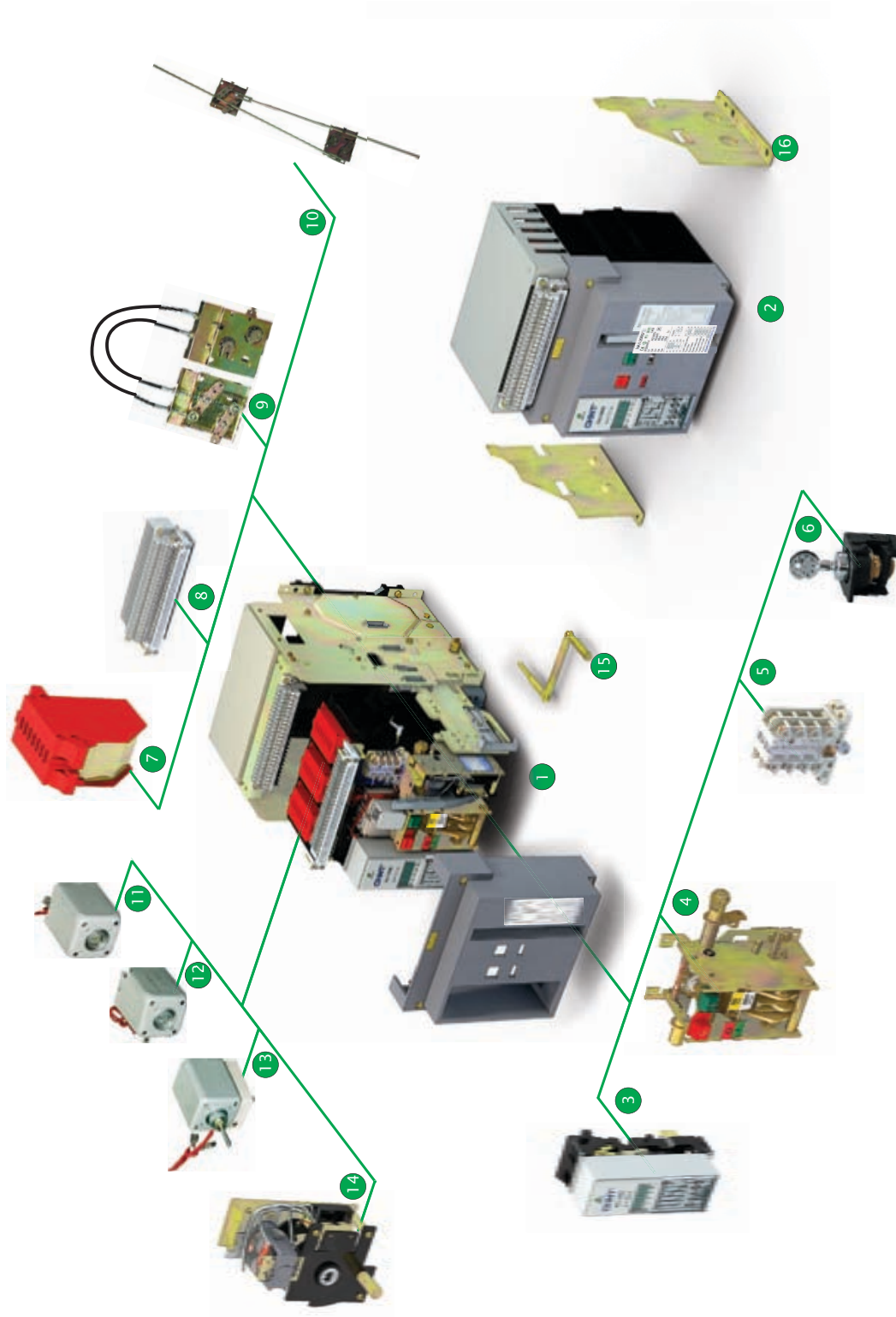



RDC Relés diferenciales

F5	Referencia	Características	P.V.P.
	RDC-01	Relé diferencial electrónico * Sensibilidades fijas: 0.3A ó 0.5A * Tensiones de servicio 50/60Hz: 110Vca/Vcc, 230/400Vca * Señalización mediante LEDs: ON y disparo * Relé de salida: Normalmente en reposo * Contactos de salida: 1NO/1NC	183,50€
	RDC-02	Relé diferencial electrónico * Sensibilidad ajustable: de 0.025A a 25A * Retardo a la desconexión ajustable: 0.02A a 5 seg. * Tensiones de servicio 50/60Hz: 110Vca/Vcc, 230/400Vca * Señalización mediante LEDs: ON y disparo * Relé de salida: Normalmente en reposo * Contactos de salida: 1NO/1NC	198,50€
	RDC-03	Relé diferencial electrónico, con transformador incorporado * Reconexión automática * Sensibilidad ajustable: de 0.025A a 25A * Retardo a la desconexión ajustable * Tensiones de servicio 50/60Hz: 110Vca/Vcc, 230/400Vca * Señalización mediante LEDs: ON y disparo * Relé de salida: Normalmente en reposo * Contactos de salida: 1NO/1NC * Diámetro interior del transformador: 28mm	257,80€
	RDC-04	Relé diferencial electrónico Mismas características que RDC-03, para trafo.independiente	257,80€
	RDC-21/35	Relé diferencial electrónico, con transformador incorporado * Sensibilidad ajustable: de 0.025A a 25A * Retardo a la desconexión ajustable	183,50€
	RDC-21/60	* Tensiones de servicio 50/60Hz: 110Vca/Vcc, 230/400Vca * Señalización mediante LEDs: ON y disparo	196,50€
	RDC-21/110	* Relé de salida: Normalmente en reposo * Contactos de salida: 1NO/1NC * Diámetro interior del transformador: 35, 60, 110mm	224,50€



TTC Transformadores toroidales

F5	Referencia	Características	P.V.P.
	TTC-028D	Transformador toroidal cerrado - Diam.:28mm - Para guía Din	47,30€
	TTC-035C	Transformador toroidal cerrado - Diam.interior: 35mm	62,30€
	TTC-060C	Transformador toroidal cerrado - Diam.interior: 60mm	71,80€
	TTC-080C	Transformador toroidal cerrado - Diam.interior: 80mm	98,60€
	TTC-110C	Transformador toroidal cerrado - Diam.interior: 110mm	133,30€
	TTC-160C	Transformador toroidal cerrado - Diam.interior: 160mm	344,10€
	TTC-210C	Transformador toroidal cerrado - Diam.interior: 210mm	378,40€
	TTC-110A	Transformador toroidal abierto - Diam.interior: 110mm	248,50€
	TTC-160A	Transformador toroidal abierto - Diam.interior: 160mm	378,00€
	TTC-210A	Transformador toroidal abierto - Diam.interior: 210mm	404,70€





NP72

Aparatos de medida analógicos

F1	Referencia	Características	P.V.P.
	NP72/ADIR/(*)	Amperímetros directos Escalas (*): 5, 10, 15, 20, 40, 60, 100A	30,70€
	NP72/AIND/(*)	Amperímetros indirectos .../5A Escalas (*): 40, 60, 75, 100, 150, 200, 250, 300, 350, 400, 500, 600, 750, 800, 1000, 1200, 1500, 2000, 3000A	27,60€
	NP72/VOLT230	Voltímetro corriente alterna -0-230V	31,40€
	NP72/VOLT500	Voltímetro corriente alterna 0-500V	31,40€
	NP72/FREQ(*)	Frecuencímetro 45-55Hz - Tensiones (*): 110, 220, 380Vca	87,30€
	NP72/PF	Factor de Potencia - Cos.phi: 0.5-1-0.5	129,90€
	NP72/WADIR	Potencia Activa - Directa - 0,6kW a 800kW	197,90€
	NP72/WATRAF	Potencia Activa - Con trafo./100V - 1MW a 5000MW	214,50€
	NP72/WRDIR	Potencia Reactiva - Directa - 0,6kVar a 800kVar	210,60€
	NP72/WRTRAF	Potencia Reactiva - Con trafo/100V - 1MVar a 5000MVar	232,50€
	NP72/CB	Cubrebornes posterior - transparente	10,50€

Sustituir (*) por la característica requerida



RDC/RMC

Aparatos de medida digitales

F5	Referencia	Características	P.V.P.
	RDC-31	Multímetro multifunción - Montaje a panel 96x96mm Medidas: Tensión Corriente y Frecuencia Alimentación: 110/230Vca ó 230/400Vca Opcional: 2 salidas de relé en estado sólido	233,50€
	RDC-38	Analizador de redes - Montaje a panel 96x96mm Medidas: Tensión Corriente y Frecuencia, Potencia, Energía, Factor de Potencia, Temperatura, Contador de horas Alimentación: 100-125/220/240Vca Opcional: 2 salidas de relé en estado sólido Opcional: Puerto serie RS485 - Protocolo Modbus	303,50€
	RMC-31	Multímetro multifunción - Montaje a guía Din (3 módulos) Medidas: Tensión Corriente y Frecuencia Alimentación normal: 230Vca - Opcional: 110Vca ó 400Vca Salida digital ON/FF - 5-230Vca/Vcc - max.150mA Opcional: 2 salidas de relé en estado sólido	238,50€
	RMC-32	Analizador de redes - Montaje a guía Din (3 módulos) Medidas: Tensión Corriente y Frecuencia, Potencia, Energía, Factor de Potencia, Temperatura, Contador de horas Alimentación: 230Vca - Opcional: 110/400Vca Opcional: 2 salidas de relé en estado sólido Opcional: Puerto serie RS485 - Protocolo Modbus	298,50€

NC
Contactores de CA y de CC

CE	DE	CCC	UK	CCC	RCC	UL US LISTED
U.E	Alemania	Chequia	Ucrania	Rusia	Sudáfrica	EE.UU.

NC6 Minicontactores de corriente alterna - 3P, 4P - 9A/AC3 - conexión por tornillos

F1	Referencia	P	Contactos Auxiliares	Intensidad Ith - AC1	Potencia motor 380Vca - AC3			Emb.	P.V.P.
					kW	CV	A		
	NC6-3-9-10-(*)	3	1NA	20	4	5,5	9	1/100	19,20€
	NC6-3-9-01-(*)	3	1NC	20	4	5,5	9	1/100	19,20€
	NC6-4-9-00-(*)	4	-	20	4	5,5	9	1/100	19,60€
Minicontactores de corriente alterna - 3P, 4P - 9A/AC3 - conexión con pins para circuito impreso									
	NC6-K-3-9-10-(*)	3	1NA	20	4	5,5	9	1/100	19,20€
	NC6-K-3-9-01-(*)	3	1NC	20	4	5,5	9	1/100	19,20€
	NC6-K-4-9-00-(*)	4	-	20	4	5,5	9	1/100	19,60€

NC1 Contactores de corriente alterna - 3P, 4P, 2P+2P - 12A a 95A/AC3 - conexión por tornillos

F1	Referencia	P	Contactos Auxiliares	Intensidad Ith - AC1	Potencia motor 380Vca - AC3			Emb.	P.V.P.
					kW	CV	A		
	NC1-3-12-10-(*)	3	1NA	20	5,5	7,5	12	1	25,70€
	NC1-3-12-01-(*)	3	1NC	20	5,5	7,5	12	1	25,70€
	NC1-3-18-10-(*)	3	1NA	32	7,5	10	18	1	34,30€
	NC1-3-18-01-(*)	3	1NC	32	7,5	10	18	1	34,30€
	NC1-3-25-10-(*)	3	1NA	40	11	15	25	1	52,30€
	NC1-3-25-01-(*)	3	1NC	40	11	15	25	1	52,30€
	NC1-3-32-10-(*)	3	1NA	50	15	20	32	1	73,60€
	NC1-3-32-01-(*)	3	1NC	50	15	20	32	1	73,60€
	NC1-3-40-11-(*)	3	1NA+1NC	60	18,5	25	40	1	81,10€
	NC1-3-50-11-(*)	3	1NA+1NC	80	22	30	50	1	113,80€
	NC1-3-65-11-(*)	3	1NA+1NC	80	30	40	65	1	145,70€
	NC1-3-80-11-(*)	3	1NA+1NC	125	37	50	80	1	187,20€
	NC1-3-95-11-(*)	3	1NA+1NC	125	45	80	95	1	210,60€
	NC1-4-12-00-(*)	4	-	20	5,5	7,5	12	1	27,90€
	NC1-4-25-00-(*)	4	-	40	11	15	25	1	35,35€
	NC1-4-40-00-(*)	4	-	60	18,5	25	40	1	96,00€
	NC1-4-50-00-(*)	4	-	80	22	30	50	1	168,00€
	NC1-4-65-00-(*)	4	-	80	30	40	65	1	192,50€
	NC1-4-80-00-(*)	4	-	125	37	50	80	1	214,90€
	NC1-4-95-00-(*)	4	-	125	45	80	95	1	237,20€
	NC1-8-12-00-(*)	2+2	-	20	5,5	7,5	12	1	27,90€
	NC1-8-25-00-(*)	2+2	-	40	11	15	25	1	35,35€
	NC1-8-40-00-(*)	2+2	-	60	18,5	25	40	1	96,00€
	NC1-8-50-00-(*)	2+2	-	80	22	30	50	1	168,00€
	NC1-8-65-00-(*)	2+2	-	80	30	40	65	1	192,50€
	NC1-8-80-00-(*)	2+2	-	125	37	50	80	1	214,90€
	NC1-8-95-00-(*)	2+2	-	125	45	80	95	1	237,20€

Sustituir (*) por la referencia de la tensión de bobina requerida. (24, 48, 110, 230, 400Vca)

NC1-Z Contactores de corriente continua 3P - 9A a 95A/AC3 - conexión por tornillos



F1	Referencia	P	Contactos Auxiliares	Intensidad lth - AC1	Potencia motor 380Vca - AC3			Emb.	P.V.P.
					kW	CV	A		
	NC1-3-12Z-10-(*).	3	1NA	20	5,5	7,5	12	1	57,90€
	NC1-3-12Z-01-(*).	3	1NC	20	5,5	7,5	12	1	57,90€
	NC1-3-18Z-10-(*).	3	1NA	32	7,5	10	18	1	84,60€
	NC1-3-18Z-01-(*).	3	1NC	32	7,5	10	18	1	84,60€
	NC1-3-25Z-10-(*).	3	1NA	40	11	15	25	1	108,50€
	NC1-3-25Z-01-(*).	3	1NC	40	11	15	25	1	108,50€
	NC1-3-32Z-10-(*).	3	1NA	50	15	20	32	1	136,30€
	NC1-3-32Z-01-(*).	3	1NC	50	15	20	32	1	136,30€
	NC1-3-40Z-11-(*).	3	1NA+1NC	60	18,5	25	40	1	178,50€
	NC1-3-50Z-11-(*).	3	1NA+1NC	80	22	30	50	1	202,90€
	NC1-3-65Z-11-(*).	3	1NA+1NC	80	30	40	65	1	242,90€
	NC1-3-80Z-11-(*).	3	1NA+1NC	125	37	50	80	1	325,10€
	NC1-3-95Z-11-(*).	3	1NA+1NC	125	45	80	95	1	372,90€

Sustituir (*) por la referencia de la tensión de bobina requerida. (24, 48, 110, 220Vcc)

NC2 Contactores de corriente alterna 3P, 4P - 115A a 630A/AC3 - conexión por tornillos



F2	Referencia	P	Contactos Auxiliares	Intensidad lth - AC1	Potencia motor 380Vca - AC3			Emb.	P.V.P.
					kW	CV	A		
	NC2-3-115-00-(*).	3	-	200	55	75	115	1	200,00€
	NC2-3-150-00-(*).	3	-	200	75	100	150	1	252,10€
	NC2-3-185-00-(*).	3	-	275	90	125	185	1	348,90€
	NC2-3-225-00-(*).	3	-	275	110	150	225	1	379,80€
	NC2-3-265-00-(*).	3	-	315	132	180	265	1	401,00€
	NC2-3-330-00-(*).	3	-	380	160	220	330	1	625,50€
	NC2-3-400-00-(*).	3	-	450	200	270	400	1	742,60€
	NC2-3-500-00-(*).	3	-	630	250	340	500	1	854,20€
	NC2-3-630-00-(*).	3	-	800	335	455	630	1	960,60€
	NC2-4-115-00-(*).	4	-	200	55	75	115	1	271,20€
	NC2-4-150-00-(*).	4	-	200	75	100	150	1	325,50€
	NC2-4-185-00-(*).	4	-	275	90	125	185	1	390,40€
	NC2-4-225-00-(*).	4	-	275	110	150	225	1	417,00€
	NC2-4-265-00-(*).	4	-	315	132	180	265	1	444,60€
	NC2-4-330-00-(*).	4	-	380	160	220	330	1	689,30€
	NC2-4-400-00-(*).	4	-	450	200	270	400	1	848,90€
	NC2-4-500-00-(*).	4	-	630	250	340	500	1	953,30€
	NC2-4-630-00-(*).	4	-	800	335	455	630	1	1.008,20€

Sustituir (*) por la referencia de la tensión de bobina requerida. (110, 230, 400Vca)





CJ19

Contactores para corrección del Factor de Potencia - 3P - 25A a 95A - conexión por tornillos

F2	Referencia	P	Contactos Auxiliares	Intensidad (A)		Condensador (kVar)		Emb.	P.V.P.
				Nominal	Trabajo	230Vca	400Vca		
	CJ19-3-25-20-(*)	3	2NA	25	17	6	12	1	63,40€
	CJ19-3-25-02-(*)	3	2NC	25	17	6	12	1	63,40€
	CJ19-3-25-11-(*)	3	1NA+1NC	25	17	6	12	1	63,40€
	CJ19-3-32-20-(*)	3	2NA	32	23	9	18	1	84,40€
	CJ19-3-32-02-(*)	3	2NC	32	23	9	18	1	84,40€
	CJ19-3-32-11-(*)	3	1NA+1NC	32	23	9	18	1	84,40€
	CJ19-3-43-20-(*)	3	2NA	43	29	10	20	1	94,50€
	CJ19-3-43-02-(*)	3	2NC	43	29	10	20	1	94,50€
	CJ19-3-43-11-(*)	3	1NA+1NC	43	29	10	20	1	94,50€
	CJ19-3-63-21-(*)	3	2NA+1NC	63	43	15	30	1	123,20€
	CJ19-3-63-12-(*)	3	1NA+2NC	63	43	15	30	1	123,20€
	CJ19-3-95-21-(*)	3	2NA+1NC	95	63	22	40	1	166,30€
	CJ19-3-95-12-(*)	3	1NA+2NC	95	63	22	40	1	166,30€

Sustituir (*) por la referencia de la tensión de bobina requerida. (24, 48, 110, 230, 400Vca)



NC9

Contactores de vacío, C.A. - 3P - 160A a 1000A - hasta 1140V - conexión por tornillos

F5	Referencia	P	Corriente nominal (A)	Potencia motor trifásico (KW)		Emb.	P.V.P.
				660/690V	1140V		
	NC9-3-160-(*)	3	160	140	230	1	consultar
	NC9-3-250-(*)	3	250	220	380	1	consultar
	NC9-3-400-(*)	3	400	350	590	1	consultar
	NC9-3-630-(*)	3	630	540	930	1	consultar
	NC9-3-800-(*)	3	800	685	1180	1	consultar
	NC9-3-1000-(*)	3	1000	850	1480	1	consultar
	NC9-22	Contactos auxiliares 2NA+2NC para NC9-160 y NC9-250				1	consultar
	NC9-44	Contactos auxiliares 4NA+4NC para NC9-400 a NC9-1000				1	consultar

Sustituir (*) por la referencia de la tensión de bobina requerida. (110, 230, 400Vca)



F...
Contactos auxiliares - Conexión por tornillos



F2	Referencia	Descripción	Contactos	Emb.	P.V.P.
	F4-20	Contactos auxiliares para contactores NC1 y NC2 Montaje en la cabeza del contactor	2NA	6	6,50€
	F4-11		1NA+1NC	6	6,50€
	F4-02		2NC	6	6,50€
	F4-40		4NA	6	8,60€
	F4-31		3NA+1NC	6	8,60€
	F4-22		2NA+2NC	6	8,60€
	F4-13		1NA+3NC	6	8,60€
	F4-04		4NC	6	8,60€
	NCF1-11	Para contactores NC1 Montaje en el lateral del contactor	1NA+1NC	6	8,60€
	F6-20	Contactos auxiliares para minicontactores NC6 Montaje en la cabeza del contactor	2NA	6	6,50€
	F6-11		1NA+1NC	6	6,50€
	F6-02		2NC	6	6,50€
	F6-40		4NA	6	8,60€
	F6-31		3NA+1NC	6	8,60€
	F6-22		2NA+2NC	6	8,60€
	F6-13		1NA+3NC	6	8,60€
	F6-04		4NC	6	8,60€



F5
Temporizadores neumáticos - Conexión por tornillos



F2	Referencia	Descripción	Retardado a la....	Temporización	Contactos	Emb.	P.V.P.
	F5-T0	Temporizadores neumáticos para contactores NC1, NC2	Conexión	0.1-3seg.	1NA+1NC	6	33,50€
	F5-T2 (*)		Conexión	0.1-30seg.	1NA+1NC	6	33,50€
	F5-T4		Conexión	10-180seg.	1NA+1NC	6	40,20€
	F5-D0		Desconexión	0.1-3seg.	1NA+1NC	6	33,50€
	F5-D2		Desconexión	0.1-30seg.	1NA+1NC	6	33,50€
	F5-D4		Desconexión	10-180seg.	1NA+1NC	6	40,20€

(*) Para arrancadores estrella-triángulo

CE

U.E



BMH

Bloqueos mecánicos horizontales para contactores NC1 y NC2



F2	Referencia	Descripción	Para contactores	Montaje	Emb.	P.V.P.
	BMH-9	Bloqueo mecánico horizontal entre contactores NC1	9, 12, 18, 25, 32	Lateral	1	11,60€
	BMH-40		40, 50, 63	Lateral	1	11,60€
	BMH-80		80, 95	Lateral	1	11,60€
	BMH-115	Bloqueo mecánico horizontal entre contactores NC2	115, 150	Lateral	1	20,10€
	BMH-185		185	Lateral	1	22,90€
	BMH-265		225, 265, 330, 400, 500	Lateral	1	32,40€
	BMH-630		630	Lateral	1	95,50€

CE

U.E



Bloqueos verticales (por varillaje) para contactores NC2

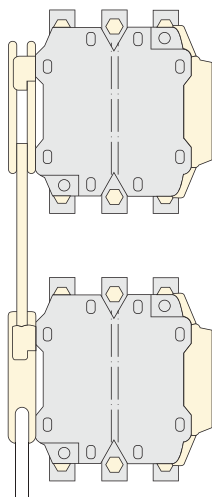

F2	Referencia	Descripción	Para bloqueo entre contactores NC2... y NC2...	Montaje	Emb.	P.V.P.
	FF	Bloqueo mecánico vertical entre contactores NC2	115/150	Vertical	1	8,20€
	FG		115/150 y 185/225	Vertical	1	9,40€
	FH		115/150 y 265/330	Vertical	1	15,50€
	FK		115/150 y 400/500	Vertical	1	15,50€
	FL		115/150 y 630	Vertical	1	18,30€
	GG		185/225	Vertical	1	9,00€
	GH		185/225 y 265/330	Vertical	1	14,70€
	GK		185/225 y 400/500	Vertical	1	14,70€
	GL		185/225 y 630	Vertical	1	17,40€
	HH		265/330	Vertical	1	19,50€
	HK		265/330 y 400/500	Vertical	1	14,70€
	HL		265/330 y 630	Vertical	1	17,40€
	KK		400/500	Vertical	1	14,70€
	KL		400/500 y 630	Vertical	1	14,70€
	LL	630	Vertical	1	17,40€	

CE

U.E



SR2

Filtros antiparasitarios



F2	Referencia	Descripción	Tensión bobina	Para contactores	Emb.	P.V.P.
	SR2-A-24	Filtro antiparasitario para contactores NC1	24-48Vca	NC1-9 a NC1-32	1	10,80€
	SR2-A-230		100-230Vca	NC1-9 a NC1-32	1	10,80€
	SR2-A-400		380-440Vca	NC1-9 a NC1-32	1	10,80€
	SR2-B-24		24-48Vca	NC1-40 a NC1-95	1	14,30€
	SR2-B-230		100-230Vca	NC1-40 a NC1-95	1	14,30€
	SR2-B-400		380-440Vca	NC1-40 a NC1-95	1	14,30€

CE						
U.E.	Alemania	Chequia	Ucrania	Rusia	Sudáfrica	EE.UU.

NR2-11.5

Relés térmicos electromecánicos para minicontactores NC6



F1	Referencia	Corriente nominal (A)	Escala regulación		Para contactores	Embalaje	P.V.P.
			Min(A)	Max(A)			
	NR2-11.5-0,16	13	0,10	0,16	NC6 (minicontactor)	1/100	32,50€
	NR2-11.5-0,25		0,16	0,25		1/100	32,50€
	NR2-11.5-0,4		0,25	0,40		1/100	32,50€
	NR2-11.5-0,63		0,40	0,63		1/100	32,50€
	NR2-11.5-1		0,63	1,00		1/100	32,50€
	NR2-11.5-1,6		1,00	1,60		1/100	32,50€
	NR2-11.5-2		1,25	2,00		1/100	32,50€
	NR2-11.5-2,5		1,60	2,50		1/100	32,50€
	NR2-11.5-4		2,50	4,00		1/100	32,50€
	NR2-11.5-6		4,00	6,00		1/100	32,50€
	NR2-11.5-8		5,50	8,00		1/100	32,50€
	NR2-11.5-10		7,00	10,00		1/100	32,50€
	NR2-11.5-13		9,00	13,00		1/100	32,50€

NR2-25

Relés térmicos electromecánicos para contactores NC1 y NC2



F1	Referencia	Corriente nominal (A)	Escala regulación		Para contactores	Embalaje	P.V.P.
			Min(A)	Max(A)			
	NR2-25-0,25	25	0,16	0,25	NC1-9, 12, 18 NC1-25, 32	1/100	33,45€
	NR2-25-0,4		0,25	0,40		1/100	33,45€
	NR2-25-0,63		0,40	0,63		1/100	33,45€
	NR2-25-1		0,63	1,00		1/100	33,45€
	NR2-25-1,6		1,00	1,60		1/100	33,45€
	NR2-25-2		1,25	2,00		1/100	33,45€
	NR2-25-2,5		1,60	2,50		1/100	33,45€
	NR2-25-4		2,50	4,00		1/100	33,45€
	NR2-25-6		4,00	6,00		1/100	33,45€
	NR2-25-8		5,50	8,00		1/100	33,45€
	NR2-25-10		7,00	10,00		1/100	33,45€
	NR2-25-13		9,00	13,00		1/100	33,45€
	NR2-25-18		12,00	18,00		1/100	33,45€
	NR2-25-25		17,00	25,00		1/100	33,45€
	NR2-36-32		36	23,00		32,00	NC1-32
	NR2-36-36	28,00		36,00	1	40,40€	
	NR2-93-32	93	23,00	32,00	NC1-40, 50, 65 NC1-80, 95	1	72,20€
	NR2-93-40		30,00	40,00		1	72,20€
	NR2-93-50		37,00	50,00		1	72,20€
	NR2-93-65		48,00	65,00		1	72,20€
	NR2-93-70		55,00	70,00		1	72,20€
	NR2-93-80		63,00	80,00		1	72,20€
	NR2-93-93		80,00	93,00		1	72,20€

NR2

Relés térmicos electromecánicos para contactores NC2



F1	Referencia	Corriente nominal (A)	Escala regulación		Para contactores	Embalaje	P.V.P.
			Min(A)	Max(A)			
	NR2-150-104	150	80	104	NC2-115 NC2-150	1	250,40€
	NR2-150-120		95	120		1	250,40€
	NR2-150-150		110	150		1	250,40€
	NR2-200-125	200	80	125	NC2-185 NC2-225	1	288,00€
	NR2-200-160		100	160		1	288,00€
	NR2-200-200		125	200		1	288,00€
	NR2-630-250	630	160	250	NC2-225 NC2-300 NC2-400 NC2-500 NC2-630	1	304,20€
	NR2-630-315		200	315		1	304,20€
	NR2-630-400		250	400		1	304,20€
	NR2-630-500		315	500		1	304,20€
	NR2-630-630		400	630		1	304,20€



NRE8

Relés térmicos electrónicos para contactores NC1 y NC2



F1	Referencia	Corriente nominal (A)	Escala regulación		Para contactores	Embalaje	P.V.P.	
			Min(A)	Max(A)				
	NRE8-25-1,2	25	0,6	1,2	NC1-9, NC1-12	1	41,80€	
	NRE8-25-2,4		1,2	2,4		1	41,80€	
	NRE8-25-4		2	4		1	41,80€	
	NRE8-25-8		4	8	1	41,80€		
	NRE8-25-10		5	10	NC1-12	1	41,80€	
	NRE8-25-12		7	12	1	41,80€		
	NRE8-25-20		10	20	NC1-18, NC1-25	1	41,80€	
	NRE8-25-25		20	25	NC1-25	1	50,50€	
	NRE8-25-32		22	32		1	50,50€	
	NRE8-40-4		40	2	4	NC1-32, NC1-40	1	52,80€
	NRE8-40-8			4	8		1	52,80€
	NRE8-40-10			5	10		1	52,80€
	NRE8-40-20	10		20	1		52,80€	
	NRE8-40-40	20		40	1		52,80€	
	NRE8-100-65	100	30	65	NC1-50, NC1-65	1	82,40€	
	NRE8-100-100		50	100	NC1-80, NC1-95	1	90,30€	
	NRE8-200-120	200	85	120	NC2-115, NC2-150 NC2-185, NC2-225	1	313,00€	
	NRE8-200-160		110	160		1	315,30€	
	NRE8-200-200		140	200		1	330,00€	
	NRE8-630-250	630	170	250	NC2-225, NC2-265 NC2-330, NC2-400 NC2-500, NC2-630	1	340,20€	
	NRE8-630-315		215	315		1	343,30€	
	NRE8-630-400		275	400		1	354,80€	
	NRE8-630-500		340	500		1	375,60€	
	NRE8-630-630		430	630		1	380,70€	

BRT

Bases para montaje independiente de relés térmicos NR2 y NRE8



F1	Referencia	Descripción	Para relés térmicos	Embalaje	P.V.P.
	BRT-NR2-25	Base montaje independiente para relés térmicos	NR2-25	6	21,30€
	BRT-NR2-36		NR2-36	6	22,40€
	BRT-NR2-93		NR2-93	6	25,50€
	BRT-NRE8-25		NRE8-25	6	21,30€
	BRT-NRE8-40		NRE8-40	6	22,40€

NS2 Guardamotores trifásicos

CE	S	CS	005	PG	RCC	eUL US LISTED
U.E	Suecia	Chequia	Ucrania	Rusia	Sudáfrica	EE.UU.



F1	Referencia	Corrientes de ajuste (A)	Potencia nom. motores trifásicos (kW) AC3, 50/60Hz			Embalaje	P.V.P.
			230/240V	400V	440V		
	NS2-25-0,16	0.1~0.16	-	-	-	1	45,90€
	NS2-25-0,25	0.16~0.25	-	-	-	1	45,90€
	NS2-25-0,4	0.25~0.4	-	-	-	1	45,90€
	NS2-25-0,63	0.4~0.63	-	-	-	1	45,90€
	NS2-25-1	0.63~1	-	-	0,37	1	45,90€
	NS2-25-1,6	1~1.6	-	0,37	0,55	1	45,90€
	NS2-25-2,5	1.6~2.5	0,37	0,75	1,1	1	45,90€
	NS2-25-4	2.5~4	0,75	1,5	1,5	1	45,90€
	NS2-25-6,3	4~6.3	1,1	2,2	3	1	45,90€
	NS2-25-10	6~10	2,2	4	4	1	45,90€
	NS2-25-14	9~14	3	5,5	7,5	1	45,90€
	NS2-25-18	13~18	4	7,5	9	1	48,10€
	NS2-25-23	17~23	5,5	11	11	1	51,00€
	NS2-25-25	20~25	5,5	11	11	1	53,50€
	NS2-80B-25	16~25	5,5	11	11	1	103,20€
	NS2-80B-40	25~40	11	18,5	22	1	112,60€
	NS2-80B-63	40~63	15	30	33	1	142,50€
	NS2-80B-80	56~80	22	40	45	1	147,20€

Accesorios para guardamotores NS2-25

F1	Referencia	Descripción		Embalaje	P.V.P.
	NS2-UV(*)	Bobina mínima tensión - C.Alterna	ver tensiones	1	27,20€
	NS2-SH(*)	Bobina emisión de corriente - C.Alterna	ver tensiones	1	27,20€
	NS2-AE20	Contacto auxiliar central	2NA	1	5,80€
	NS2-AE11	Contacto auxiliar central	1NA+1NC	1	5,80€
	NS2-AU20	Contacto auxiliar lado izquierdo	2NA	1	11,60€
	NS2-AU11	Contacto auxiliar lado izquierdo	1NA+1NC	1	11,60€
	NS2-FA0110	Contacto auxiliar + alarma	1NC+1NA	1	10,40€
	NS2-FA0101	Contacto auxiliar + alarma	1NC+1NC	1	10,40€
	NS2-FA1010	Contacto auxiliar + alarma	1NA+1NA	1	10,40€
	NS2-FA1001	Contacto auxiliar + alarma	1NA+1NC	1	10,40€
	NS2-BOX-MC	Caja de superficie	IP55	1	22,40€
	NS2-BOX-PE	Caja superf. con pulsador emergencia	IP55	1	31,10€

Sustituir (*) por la tensión requerida: 110, 230, 400, 440Vca

Accesorios para guardamotores NS2-80B

F1	Referencia	Descripción		Embalaje	P.V.P.
	NS2-AU20/80	Contacto auxiliar lado izquierdo	2NA	1	11,60€
	NS2-AU11/80	Contacto auxiliar lado izquierdo	1NA+1NC	1	11,60€



MANIOBRAS MONTADAS

NQ2

Caja metálica, IP40, con pulsadores paro-marcha - sin relé térmico



F2	Referencia	Corriente nominal (A)	Potencia motor (AC3) (kW)		Contactor montado	Embalaje	P.V.P.
			220/230V	380/400V			
	NQ2-15P/12-(*)	12	3	5,5	NC1-03-12	1	45,10€
	NQ2-15P/18-(*)	18	4	7,5	NC1-03-18	1	58,35€
	NQ2-15P/25-(*)	25	5,5	11	NC1-03-25	1	73,00€
	NQ2-15P/32-(*)	32	9	15	NC1-03-32	1	108,00€

Sustituir (*) por la tensión de bobina requerida: 24, 48, 110, 230, 400Vca

AD1

Caja plástica, IP65, con pulsadores paro-marcha - sin relé térmico



F2	Referencia	Corriente nominal (A)	Potencia motor (AC3) (kW)		Contactor montado	Embalaje	P.V.P.
			220/230V	380/400V			
	AD1/12-(*)	12	3	5,5	NC1-03-12	1	42,40€
	AD1/18-(*)	18	4	7,5	NC1-03-18	1	47,80€

Sustituir (*) por la tensión de bobina requerida: 24, 48, 110, 230, 400Vca

NC1-NI

Inversores tripolares montados - sin relés térmicos



F2	Referencia	Corriente nominal (A)	Potencia motor (AC3) (kW)		Contactores montados	Embalaje	P.V.P.
			220/230V	380/400V			
	NC1-312NI-(*)	12	3	5,5	NC1-03-12	1	83,60€
	NC1-318NI-(*)	18	4	7,5	NC1-03-18	1	113,70€
	NC1-325NI-(*)	25	5,5	11	NC1-03-25	1	131,30€
	NC1-332NI-(*)	32	7,5	15	NC1-03-32	1	180,80€
	NC1-340NI-(*)	40	11	18,5	NC1-03-40	1	240,10€
	NC1-350NI-(*)	50	15	22	NC1-03-50	1	301,30€
	NC1-365NI-(*)	65	18,5	30	NC1-03-65	1	395,80€
	NC1-380NI-(*)	80	22	37	NC1-03-80	1	493,70€
	NC1-395NI-(*)	95	25	45	NC1-03-95	1	503,20€

Sustituir (*) por la tensión de bobina requerida: 24, 48, 110, 230, 400Vca

NC1-NC

Conmutadores tetrapolares montados - sin relés térmicos



F2	Referencia	Corriente nominal (A)	Potencia motor (AC3) (kW)		Contactores montados	Embalaje	P.V.P.
			220/230V	380/400V			
	NC1-412NC-(*)	12	3	5,5	NC1-04-12	1	97,30€
	NC1-425NC-(*)	25	5,5	11	NC1-04-25	1	150,80€
	NC1-440NC-(*)	40	11	18,5	NC1-04-40	1	311,30€
	NC1-450NC-(*)	50	15	22	NC1-04-50	1	361,20€
	NC1-465NC-(*)	65	18,5	30	NC1-04-65	1	482,60€
	NC1-480NC-(*)	80	22	37	NC1-04-80	1	619,30€
	NC1-495NC-(*)	95	25	45	NC1-04-95	1	743,80€

Sustituir (*) por la tensión de bobina requerida: 24, 48, 110, 230, 400Vca

NC2-NI

Inversores tripolares montados - sin relés térmicos

F2	Referencia	Corriente nominal (A)	Potencia motor (AC3) (kW)		Contactores montados	Embalaje	P.V.P.
			220/230V	380/400V			
	NC2-3115NI-(*).	115	55	80	NC2-03-115	1	524,30€
	NC2-3150NI-(*).	150	75	100	NC2-03-150	1	616,90€
	NC2-3185NI-(*).	185	90	110	NC2-03-185	1	834,80€
	NC2-3225NI-(*).	225	110	129	NC2-03-225	1	906,40€
	NC2-3265NI-(*).	265	132	160	NC2-03-265	1	964,30€
	NC2-3330NI-(*).	330	160	220	NC2-03-330	1	1.451,60€
	NC2-3400NI-(*).	400	200	280	NC2-03-400	1	1.693,70€
	NC2-3500NI-(*).	500	250	335	NC2-03-500	1	1.904,20€
	NC2-3630NI-(*).	630	335	460	NC2-03-630	1	2.123,10€

Sustituir (*) por la tensión de bobina requerida: 110, 230, 400Vca

NC2-NC

Conmutadores tetrapolares montados - sin relés térmicos

F2	Referencia	Corriente nominal (A)	Corriente máxima de empleo a 440V/AC1 (A)	Contactores montados	Embalaje	P.V.P.
	NC2-4150NC-(*).	150	200	NC2-04-150	1	945,30€
	NC2-4185NC-(*).	185	275	NC2-04-185	1	1.000,00€
	NC2-4225NC-(*).	225	275	NC2-04-225	1	1.156,80€
	NC2-4265NC-(*).	265	315	NC2-04-265	1	1.220,00€
	NC2-4330NC-(*).	330	380	NC2-04-330	1	1.714,70€
	NC2-4400NC-(*).	400	450	NC2-04-400	1	2.041,00€
	NC2-4500NC-(*).	500	630	NC2-04-500	1	2.228,40€
	NC2-4630NC-(*).	630	800	NC2-04-630	1	2.504,20€

Sustituir (*) por la tensión de bobina requerida: 110, 230, 400Vca



INVERSOR

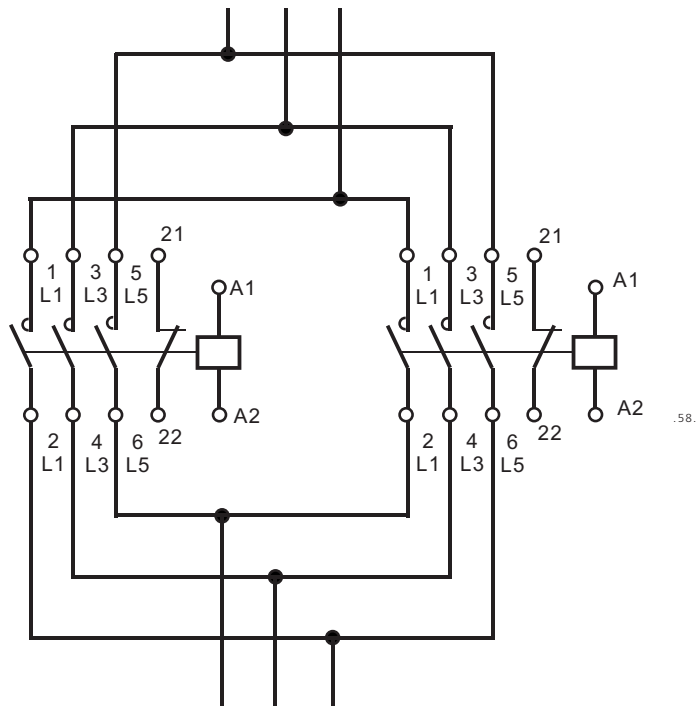

CONMUTADOR

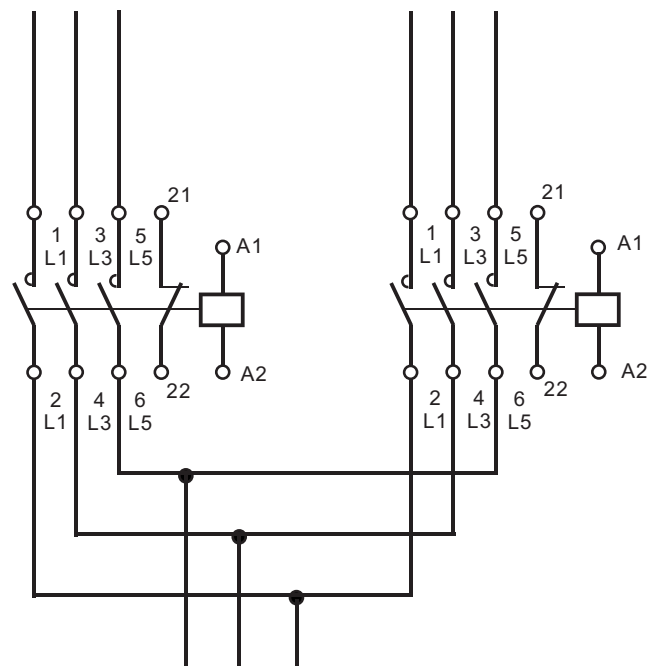

QJX2 Arranadores Estrella-Triángulo
Composición de los arranadores

Referencia	Potencia Motor 380/400V		Contactores de Línea y Triángulo	Contactor Estrella	Relé Térmico	Temporiz. 1-30seg	Contactos Auxiliares
	KW	CV					
QJX2-7,5/10-(*)	7,5	10	NC1-03-09-10	NC1-03-09-10	NR2-25-10	F5-T2	F4-11
QJX2-10/14-(*)	10	14	NC1-03-12-10	NC1-03-09-10	NR2-25-13	F5-T2	F4-11
QJX2-15/20-(*)	15	20	NC1-03-18-10	NC1-03-12-10	NR2-25-18	F5-T2	F4-11
QJX2-18,5/25-(*)	18,5	25	NC1-03-25-10	NC1-03-18-10	NR2-25-25	F5-T2	F4-11
QJX2-25/34-(*)	25	34	NC1-03-32-10	NC1-03-25-10	NR2-36-32	F5-T2	F4-11
QJX2-33/45-(*)	33	45	NC1-03-40-11	NC1-03-25-10	NR2-93-50	F5-T2	F4-11
QJX2-45/60-(*)	45	60	NC1-03-50-11	NC1-03-40-11	NR2-93-65	F5-T2	F4-11
QJX2-55/75-(*)	55	75	NC1-03-65-11	NC1-03-40-11	NR2-93-65	F5-T2	F4-11
QJX2-63/85-(*)	63	85	NC1-03-80-11	NC1-03-50-11	NR2-93-80	F5-T2	F4-11
QJX2-80/110-(*)	80	110	NC1-03-95-11	NC1-03-50-11	NR2-93-93	F5-T2	F4-11
QJX2-110/150-(*)	110	150	NC2-03-115	NC1-03-80-11	NR2-150-150	F5-T2	F4-11
QJX2-132/180-(*)	132	180	NC2-03-150	NC2-03-115	NR2-200-200	F5-T2	F4-11
QJX2-160/217-(*)	160	217	NC2-03-185	NC2-03-150	NR2-200-200	F5-T2	F4-11
QJX2-185/251-(*)	185	251	NC2-03-225	NC2-03-185	NR2-630-250	F5-T2	F4-11
QJX2-220/299-(*)	220	299	NC2-03-265	NC2-03-185	NR2-630-315	F5-T2	F4-11
QJX2-280/380-(*)	280	380	NC2-03-330	NC2-03-265	NR2-630-400	F5-T2	F4-11
QJX2-315/428-(*)	315	428	NC2-03-400	NC2-03-265	NR2-630-400	F5-T2	F4-11
QJX2-450/611-(*)	450	611	NC2-03-500	NC2-03-330	NR2-630-500	F5-T2	F4-11
QJX2-630/856-(*)	630	856	NC2-03-630	NC2-03-400	Transform.(**)	F5-T2	F4-11

QJX2
Arranadores Estrella-Triángulo - 7,5kW a 630kW

F2	Referencia	Potencia Motor 380/400V		Corriente (A) <440V	Ajuste Relé térmico (A)	Potencia (KW)				P.V.P.
		KW	CV			230V	400V	415V	440V	
	QJX2-7,5/10-(*)	7,5	10	15,5	9	4	7,5	7,5	7,5	181,90€
	QJX2-10/14-(*)	10	14	20	11,6	5,5	10	10	10	197,50€
	QJX2-15/20-(*)	15	20	30	17,4	11	15	15	15	237,70€
	QJX2-18,5/25-(*)	18,5	25	37	21,5	11	18,5	22	22	240,60€
	QJX2-25/34-(*)	25	34	52	30,2	15	25	25	25	324,60€
	QJX2-33/45-(*)	33	45	68	39,5	18,5	33	37	37	327,80€
	QJX2-45/60-(*)	45	60	85	49,3	25	45	45	45	440,00€
	QJX2-55/75-(*)	55	75	105	60,9	30	55	59	59	571,90€
	QJX2-63/85-(*)	63	85	117	67,9	37	63	75	75	584,80€
	QJX2-80/110-(*)	80	110	147	85,3	45	80	80	80	813,70€
	QJX2-110/150-(*)	110	150	205	118,9	63	110	110	110	963,00€
	QJX2-132/180-(*)	132	180	245	142,1	75	132	132	150	1.112,50€
	QJX2-160/217-(*)	160	217	300	174	90	160	160	185	1.434,50€
	QJX2-185/251-(*)	185	251	350	203	100	185	185	200	1.664,50€
	QJX2-220/299-(*)	220	299	410	237,8	110	220	220	250	1.742,70€
	QJX2-280/380-(*)	280	380	520	302	160	280	280	320	2.308,50€
	QJX2-315/428-(*)	315	428	580	336,7	185	315	355	370	2.676,50€
	QJX2-450/611-(*)	450	611	830	482	250	450	475	500	3.217,00€
	QJX2-630/856-(*)	630	856	1,100	638	315	630	630	750	3.631,00€



Sustituir (*) por la tensión de bobina requerida:
 - Contactores NC1: 24, 48, 110, 230, 400Vca
 - Contactores NC2: 110, 230, 400Vca

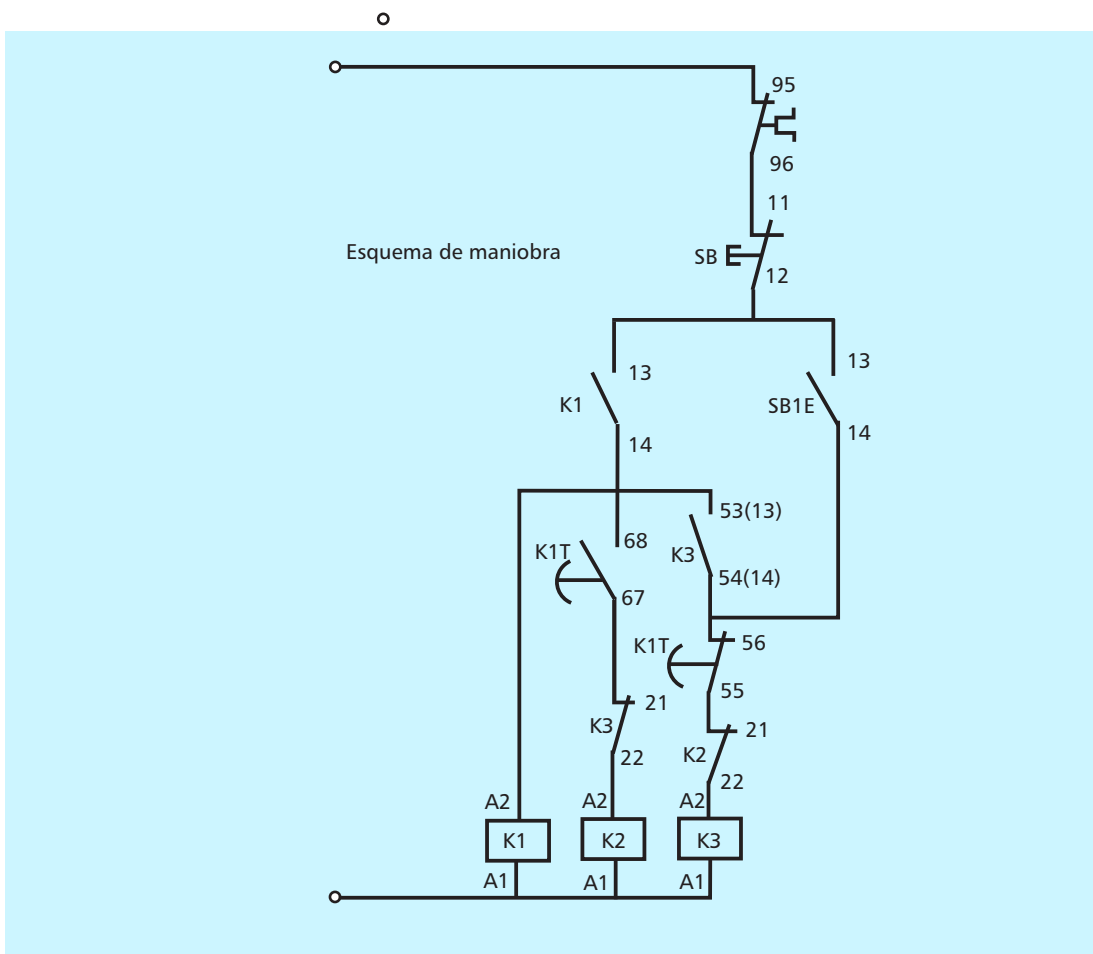
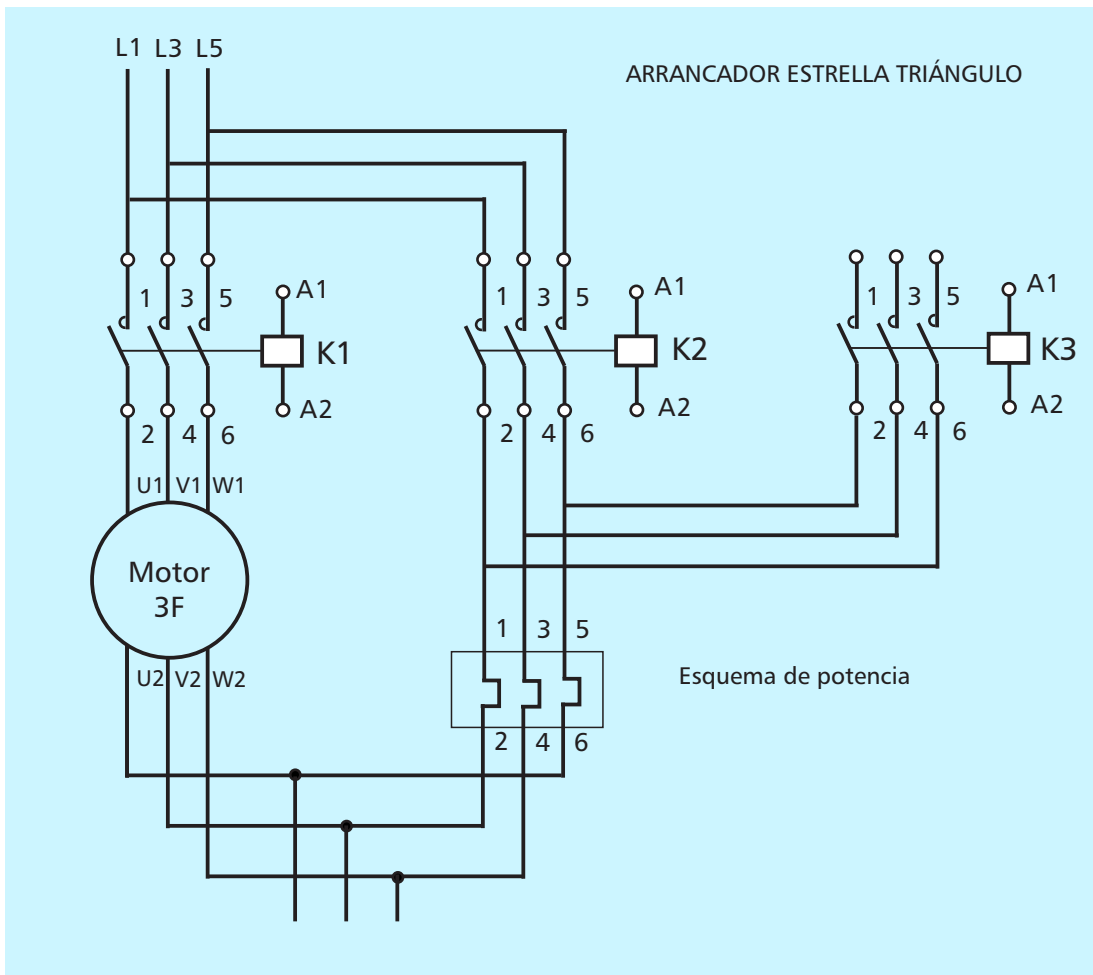

NP2
Auxiliares de mando (Diámetro: 22mm)

Pulsadores plásticos - rasantes momentáneos

F1	NP2-EA (**)	Referencia	Color	NA	NC	P.V.P.
		NP2-EA11		1	-	6,35€
		NP2-EA21		1	-	6,35€
		NP2-EA31		1	-	6,35€
		NP2-EA41		1	-	6,35€
		NP2-EA51		1	-	6,35€
		NP2-EA61		1	-	6,35€
		NP2-EA12		-	1	6,35€
		NP2-EA22		-	1	6,35€
		NP2-EA32		-	1	6,35€
		NP2-EA42		-	1	6,35€
		NP2-EA52		-	1	6,35€
		NP2-EA62		-	1	6,35€
		NP2-EA13		2	-	7,80€
		NP2-EA23		2	-	7,80€
		NP2-EA33		2	-	7,80€
		NP2-EA43		2	-	7,80€
		NP2-EA53		2	-	7,80€
		NP2-EA63		2	-	7,80€
		NP2-EA14		-	2	7,80€
		NP2-EA24		-	2	7,80€
		NP2-EA34		-	2	7,80€
		NP2-EA44		-	2	7,80€
		NP2-EA54		-	2	7,80€
		NP2-EA64		-	2	7,80€
		NP2-EA15		1	1	7,80€
		NP2-EA25		1	1	7,80€
		NP2-EA35		1	1	7,80€
		NP2-EA45		1	1	7,80€
		NP2-EA55		1	1	7,80€
		NP2-EA65		1	1	7,80€



Embalajes: Todos los aparatos de las series NP2 y ND16 (auxiliares de mando de diámetro 22mm) se suministran en cajas de 10 unidades

Colores							
	1	2	3	4	5	6	7
	Blanco	Negro	Verde	Rojo	Amarillo	Azul	Naranja

NP2

Auxiliares de mando (Diámetro: 22mm)





Pulsadores metálicos - rasantes momentáneos

F1	NP2-BA(**)	Referencia	Color	NA	NC	P.V.P.
		NP2-BA11	○	1	-	8,40€
		NP2-BA21	●	1	-	8,40€
		NP2-BA31	●	1	-	8,40€
		NP2-BA41	●	1	-	8,40€
		NP2-BA51	●	1	-	8,40€
		NP2-BA61	●	1	-	8,40€
		NP2-BA12	○	-	1	8,40€
		NP2-BA22	●	-	1	8,40€
		NP2-BA32	●	-	1	8,40€
		NP2-BA42	●	-	1	8,40€
		NP2-BA52	●	-	1	8,40€
		NP2-BA62	●	-	1	8,40€
		NP2-BA13	○	2	-	9,15€
		NP2-BA23	●	2	-	9,15€
		NP2-BA33	●	2	-	9,15€
		NP2-BA43	●	2	-	9,15€
		NP2-BA53	●	2	-	9,15€
		NP2-BA63	●	2	-	9,15€
		NP2-BA14	○	-	2	9,15€
		NP2-BA24	●	-	2	9,15€
		NP2-BA34	●	-	2	9,15€
		NP2-BA44	●	-	2	9,15€
		NP2-BA54	●	-	2	9,15€
		NP2-BA64	●	-	2	9,15€
		NP2-BA15	○	1	1	9,15€
		NP2-BA25	●	1	1	9,15€
		NP2-BA35	●	1	1	9,15€
		NP2-BA45	●	1	1	9,15€
		NP2-BA55	●	1	1	9,15€
		NP2-BA65	●	1	1	9,15€





Pulsadores de plástico dobles - momentáneos - normales y luminosos

F1	NP2-EL/EW(**)	Tipo/Lámpara	Referencia	Color	NA	NC	P.V.P.
		Pulsador rojo rasante	NP2-EL8325	● + ●	1	1	13,20€
		Pulsador rojo saliente	NP2-EL8425	● + ●	1	1	13,20€
		LED c.a.: 6V, 12V, 24V, 36V, 48V, 110V, 230V	NP2-EW8465	● + ●	1	1	19,70€
		LED c.a.: 6V Transformador: 230, 380V	NP2-EW8475	● + ●	1	1	25,30€

Pulsadores de plástico - rasantes momentáneos - luminosos - Conexión directa

F1	NP2-EW(**)	Lámpara	Referencia	Color	NA	NC	P.V.P.
		LED corriente alterna Sustituir (*) por la tensión de la lámpara: 6V, 12V, 24V, 36V, 48V, 110V, 230V	NP2-EW3161/L/(*)	○	1	-	17,70€
			NP2-EW3361/L/(*)	●	1	-	17,70€
			NP2-EW3461/L/(*)	●	1	-	17,70€
			NP2-EW3561/L/(*)	●	1	-	17,70€
			NP2-EW3661/L/(*)	●	1	-	17,70€
			NP2-EW3162/L/(*)	○	-	1	17,70€
			NP2-EW3362/L/(*)	●	-	1	17,70€
			NP2-EW3462/L/(*)	●	-	1	17,70€
			NP2-EW3562/L/(*)	●	-	1	17,70€
			NP2-EW3662/L/(*)	●	-	1	17,70€
			NP2-EW3165/L/(*)	○	1	1	20,40€
			NP2-EW3365/L/(*)	●	1	1	20,40€
			NP2-EW3465/L/(*)	●	1	1	20,40€
			NP2-EW3565/L/(*)	●	1	1	20,40€
			NP2-EW3665/L/(*)	●	1	1	20,40€
			NP2-EW3163/L/(*)	○	2	-	20,40€
			NP2-EW3363/L/(*)	●	2	-	20,40€
			NP2-EW3463/L/(*)	●	2	-	20,40€
			NP2-EW3563/L/(*)	●	2	-	20,40€
			NP2-EW3663/L/(*)	●	2	-	20,40€
NP2-EW3164/L/(*)	○	-	2	20,40€			
NP2-EW3364/L/(*)	●	-	2	20,40€			
NP2-EW3464/L/(*)	●	-	2	20,40€			
NP2-EW3564/L/(*)	●	-	2	20,40€			
NP2-EW3664/L/(*)	●	-	2	20,40€			

Pulsadores metálicos dobles - momentáneos - normales y luminosos

F1	NP2-BL/BW(**)	Tipo/Lámpara	Referencia	Color	NA	NC	P.V.P.
		Pulsador rojo rasante	NP2-BL8325	● + ●	1	1	14,90€
		Pulsador rojo saliente	NP2-BL8425	● + ●	1	1	14,90€
		LED c.a.: 6V, 12V, 24V, 36V, 48V, 110V, 230V	NP2-BW8465	● + ●	1	1	20,90€
		LED c.a.: 6V Transformador: 230, 380V	NP2-BW8475	● + ●	1	1	26,80€

Pulsadores metálicos - rasantes momentáneos - luminosos - Conexión directa

F1	NP2-BW (**)	Lámpara	Referencia	Color	NA	NC	P.V.P.
		LED corriente alterna Sustituir (*) por la tensión de la lámpara: 6V, 12V, 24V, 36V, 48V, 110V, 230V	NP2-BW3161/L/(*)	○	1	-	21,00€
			NP2-BW3361/L/(*)	●	1	-	21,00€
			NP2-BW3461/L/(*)	●	1	-	21,00€
			NP2-BW3561/L/(*)	●	1	-	21,00€
			NP2-BW3661/L/(*)	●	1	-	21,00€
			NP2-BW3162/L/(*)	○	-	1	21,00€
			NP2-BW3362/L/(*)	●	-	1	21,00€
			NP2-BW3462/L/(*)	●	-	1	21,00€
			NP2-BW3562/L/(*)	●	-	1	21,00€
			NP2-BW3662/L/(*)	●	-	1	21,00€
			NP2-BW3165/L/(*)	○	1	1	23,70€
			NP2-BW3365/L/(*)	●	1	1	23,70€
			NP2-BW3465/L/(*)	●	1	1	23,70€
			NP2-BW3565/L/(*)	●	1	1	23,70€
			NP2-BW3665/L/(*)	●	1	1	23,70€
			NP2-BW3163/L/(*)	○	2	-	23,70€
			NP2-BW3363/L/(*)	●	2	-	23,70€
			NP2-BW3463/L/(*)	●	2	-	23,70€
			NP2-BW3563/L/(*)	●	2	-	23,70€
			NP2-BW3663/L/(*)	●	2	-	23,70€
NP2-BW3164/L/(*)	○	-	2	23,70€			
NP2-BW3364/L/(*)	●	-	2	23,70€			
NP2-BW3464/L/(*)	●	-	2	23,70€			
NP2-BW3564/L/(*)	●	-	2	23,70€			
NP2-BW3664/L/(*)	●	-	2	23,70€			

Pulsadores de plástico - rasantes momentáneos - luminosos - Conexión con transformador

F1	NP2-EW(**)	Lámparas	Referencia	Color	NA	NC	P.V.P.
		LED corriente alterna: 230V	NP2-EW3141/L/230	○	1	-	27,70€
			NP2-EW3341/L/230	●	1	-	27,70€
			NP2-EW3441/L/230	●	1	-	27,70€
			NP2-EW3541/L/230	●	1	-	27,70€
			NP2-EW3641/L/230	●	1	-	27,70€
			NP2-EW3142/L/230	○	-	1	27,70€
			NP2-EW3342/L/230	●	-	1	27,70€
			NP2-EW3442/L/230	●	-	1	27,70€
			NP2-EW3542/L/230	●	-	1	27,70€
			NP2-EW3642/L/230	●	-	1	27,70€
			NP2-EW3143/L/230	○	2	-	30,40€
			NP2-EW3343/L/230	●	2	-	30,40€
			NP2-EW3443/L/230	●	2	-	30,40€
			NP2-EW3543/L/230	●	2	-	30,40€
			NP2-EW3643/L/230	●	2	-	30,40€
			NP2-EW3144/L/230	○	-	2	30,40€
			NP2-EW3344/L/230	●	-	2	30,40€
			NP2-EW3444/L/230	●	-	2	30,40€
			NP2-EW3544/L/230	●	-	2	30,40€
			NP2-EW3644/L/230	●	-	2	30,40€
		NP2-EW3145/L/230	○	1	1	30,40€	
		NP2-EW3345/L/230	●	1	1	30,40€	
		NP2-EW3445/L/230	●	1	1	30,40€	
		NP2-EW3545/L/230	●	1	1	30,40€	
		NP2-EW3645/L/230	●	1	1	30,40€	
		LED corriente alterna: 400V	NP2-EW3151/L/400	○	1	-	27,70€
			NP2-EW3351/L/400	●	1	-	27,70€
			NP2-EW3451/L/400	●	1	-	27,70€
			NP2-EW3551/L/400	●	1	-	27,70€
			NP2-EW3651/L/400	●	1	-	27,70€
			NP2-EW3152/L/400	○	-	1	27,70€
			NP2-EW3352/L/400	●	-	1	27,70€
			NP2-EW3452/L/400	●	-	1	27,70€
			NP2-EW3552/L/400	●	-	1	27,70€
			NP2-EW3652/L/400	●	-	1	27,70€
			NP2-EW3153/L/400	○	2	-	30,40€
			NP2-EW3353/L/400	●	2	-	30,40€
			NP2-EW3453/L/400	●	2	-	30,40€
			NP2-EW3553/L/400	●	2	-	30,40€
			NP2-EW3653/L/400	●	2	-	30,40€
NP2-EW3154/L/400	○		-	2	30,40€		
NP2-EW3354/L/400	●		-	2	30,40€		
NP2-EW3454/L/400	●		-	2	30,40€		
NP2-EW3554/L/400	●		-	2	30,40€		
NP2-EW3654/L/400	●		-	2	30,40€		
NP2-EW3155/L/400	○	1	1	30,40€			
NP2-EW3355/L/400	●	1	1	30,40€			
NP2-EW3455/L/400	●	1	1	30,40€			
NP2-EW3555/L/400	●	1	1	30,40€			
NP2-EW3655/L/400	●	1	1	30,40€			

Pulsadores metálicos - rasantes momentáneos - luminosos - Conexión con transformador

F1	NP2-BW(**)	Lámparas	Referencia	Color	NA	NC	P.V.P.
		LED corriente alterna: 230V	NP2-BW3141/L/230	○	1	-	33,30€
			NP2-BW3341/L/230	●	1	-	33,30€
			NP2-BW3441/L/230	●	1	-	33,30€
			NP2-BW3541/L/230	●	1	-	33,30€
			NP2-BW3641/L/230	●	1	-	33,30€
			NP2-BW3142/L/230	○	-	1	33,30€
			NP2-BW3342/L/230	●	-	1	33,30€
			NP2-BW3442/L/230	●	-	1	33,30€
			NP2-BW3542/L/230	●	-	1	33,30€
			NP2-BW3642/L/230	●	-	1	33,30€
			NP2-BW3143/L/230	○	2	-	36,00€
			NP2-BW3343/L/230	●	2	-	36,00€
			NP2-BW3443/L/230	●	2	-	36,00€
			NP2-BW3543/L/230	●	2	-	36,00€
			NP2-BW3643/L/230	●	2	-	36,00€
			NP2-BW3144/L/230	○	-	2	36,00€
			NP2-BW3344/L/230	●	-	2	36,00€
			NP2-BW3444/L/230	●	-	2	36,00€
			NP2-BW3544/L/230	●	-	2	36,00€
			NP2-BW3644/L/230	●	-	2	36,00€
		NP2-BW3145/L/230	○	1	1	36,00€	
		NP2-BW3345/L/230	●	1	1	36,00€	
		NP2-BW3445/L/230	●	1	1	36,00€	
		NP2-BW3545/L/230	●	1	1	36,00€	
		NP2-BW3645/L/230	●	1	1	36,00€	
		LED corriente alterna: 400V	NP2-BW3151/L/400	○	1	-	33,30€
			NP2-BW3351/L/400	●	1	-	33,30€
			NP2-BW3451/L/400	●	1	-	33,30€
			NP2-BW3551/L/400	●	1	-	33,30€
			NP2-BW3651/L/400	●	1	-	33,30€
			NP2-BW3152/L/400	○	-	1	33,30€
			NP2-BW3352/L/400	●	-	1	33,30€
			NP2-BW3452/L/400	●	-	1	33,30€
			NP2-BW3552/L/400	●	-	1	33,30€
			NP2-BW3652/L/400	●	-	1	33,30€
			NP2-BW3153/L/400	○	2	-	36,00€
			NP2-BW3353/L/400	●	2	-	36,00€
			NP2-BW3453/L/400	●	2	-	36,00€
			NP2-BW3553/L/400	●	2	-	36,00€
			NP2-BW3653/L/400	●	2	-	36,00€
NP2-BW3154/L/400	○		-	2	36,00€		
NP2-BW3354/L/400	●		-	2	36,00€		
NP2-BW3454/L/400	●		-	2	36,00€		
NP2-BW3554/L/400	●		-	2	36,00€		
NP2-BW3654/L/400	●		-	2	36,00€		
NP2-BW3155/L/400	○	1	1	36,00€			
NP2-BW3355/L/400	●	1	1	36,00€			
NP2-BW3455/L/400	●	1	1	36,00€			
NP2-BW3555/L/400	●	1	1	36,00€			
NP2-BW3655/L/400	●	1	1	36,00€			

Pulsadores de plástico, tipo seta - momentáneos - D:40mm

F1	NP2-EC(**)	Referencia	Color	NA	NC	P.V.P.
		NP2-EC11	○	1	-	9,30€
		NP2-EC21	●	1	-	9,30€
		NP2-EC31	●	1	-	9,30€
		NP2-EC41	●	1	-	9,30€
		NP2-EC51	●	1	-	9,30€
		NP2-EC61	●	1	-	9,30€
		NP2-EC12	○	-	1	9,30€
		NP2-EC22	●	-	1	9,30€
		NP2-EC32	●	-	1	9,30€
		NP2-EC42	●	-	1	9,30€
		NP2-EC52	●	-	1	9,30€
		NP2-EC62	●	-	1	9,30€
		NP2-EC13	○	2	-	12,10€
		NP2-EC23	●	2	-	12,10€
		NP2-EC33	●	2	-	12,10€
		NP2-EC43	●	2	-	12,10€
		NP2-EC53	●	2	-	12,10€
		NP2-EC63	●	2	-	12,10€
		NP2-EC14	○	-	2	12,10€
		NP2-EC24	●	-	2	12,10€
		NP2-EC34	●	-	2	12,10€
		NP2-EC44	●	-	2	12,10€
		NP2-EC54	●	-	2	12,10€
		NP2-EC64	●	-	2	12,10€
		NP2-EC15	○	1	1	12,10€
		NP2-EC25	●	1	1	12,10€
		NP2-EC35	●	1	1	12,10€
		NP2-EC45	●	1	1	12,10€
		NP2-EC55	●	1	1	12,10€
		NP2-EC65	●	1	1	12,10€



Pulsadores de plástico, tipo seta - momentáneos - D:60mm

F1	NP2-ER(**)	Referencia	Color	NA	NC	P.V.P.
		NP2-ER11	○	1	-	10,50€
		NP2-ER21	●	1	-	10,50€
		NP2-ER31	●	1	-	10,50€
		NP2-ER41	●	1	-	10,50€
		NP2-ER51	●	1	-	10,50€
		NP2-ER61	●	1	-	10,50€
		NP2-ER12	○	-	1	10,50€
		NP2-ER22	●	-	1	10,50€
		NP2-ER32	●	-	1	10,50€
		NP2-ER42	●	-	1	10,50€
		NP2-ER52	●	-	1	10,50€
		NP2-ER62	●	-	1	10,50€
		NP2-ER13	○	2	-	13,30€
		NP2-ER23	●	2	-	13,30€
		NP2-ER33	●	2	-	13,30€
		NP2-ER43	●	2	-	13,30€
		NP2-ER53	●	2	-	13,30€
		NP2-ER63	●	2	-	13,30€
		NP2-ER14	○	-	2	13,30€
		NP2-ER24	●	-	2	13,30€
		NP2-ER34	●	-	2	13,30€
		NP2-ER44	●	-	2	13,30€
		NP2-ER54	●	-	2	13,30€
		NP2-ER64	●	-	2	13,30€
		NP2-ER15	○	1	1	13,30€
		NP2-ER25	●	1	1	13,30€
		NP2-ER35	●	1	1	13,30€
		NP2-ER45	●	1	1	13,30€
		NP2-ER55	●	1	1	13,30€
		NP2-ER65	●	1	1	13,30€



Pulsadores de plástico, tipo seta - Girar para desbloquear

F1	NP2-ES(**)	Diámetro seta	Referencia	Color	NA	NC	P.V.P.
		30mm	NP2-ES441	●	1	-	17,00€
			NP2-ES442		-	1	17,00€
		40mm	NP2-ES541		1	-	18,10€
			NP2-ES542		-	1	18,10€
		60mm	NP2-ES641		1	-	19,30€
			NP2-ES642		-	1	19,30€
		30mm	NP2-ES443	●	2	-	19,80€
			NP2-ES444		-	2	19,80€
			NP2-ES445		1	1	19,80€
		40mm	NP2-ES543		2	-	20,90€
			NP2-ES544		-	2	20,90€
			NP2-ES545		1	1	20,90€
		60mm	NP2-ES643		2	-	22,10€
			NP2-ES644		-	2	22,10€
			NP2-ES645		1	1	22,10€



Pulsadores de plástico, tipo seta - momentáneos - D:40mm

F1	NP2-BC(**)	Referencia	Color	NA	NC	P.V.P.
		NP2-BC11	○	1	-	9,60€
		NP2-BC21	●	1	-	9,60€
		NP2-BC31	●	1	-	9,60€
		NP2-BC41	●	1	-	9,60€
		NP2-BC51	●	1	-	9,60€
		NP2-BC61	●	1	-	9,60€
		NP2-BC12	○	-	1	9,60€
		NP2-BC22	●	-	1	9,60€
		NP2-BC32	●	-	1	9,60€
		NP2-BC42	●	-	1	9,60€
		NP2-BC52	●	-	1	9,60€
		NP2-BC62	●	-	1	9,60€
		NP2-BC13	○	2	-	12,40€
		NP2-BC23	●	2	-	12,40€
		NP2-BC33	●	2	-	12,40€
		NP2-BC43	●	2	-	12,40€
		NP2-BC53	●	2	-	12,40€
		NP2-BC63	●	2	-	12,40€
		NP2-BC14	○	-	2	12,40€
		NP2-BC24	●	-	2	12,40€
		NP2-BC34	●	-	2	12,40€
		NP2-BC44	●	-	2	12,40€
		NP2-BC54	●	-	2	12,40€
		NP2-BC64	●	-	2	12,40€
		NP2-BC15	○	1	1	12,40€
		NP2-BC25	●	1	1	12,40€
		NP2-BC35	●	1	1	12,40€
		NP2-BC45	●	1	1	12,40€
		NP2-BC55	●	1	1	12,40€
		NP2-BC65	●	1	1	12,40€



Pulsadores de plástico, tipo seta - momentáneos - D:60mm

F1	NP2-BR(**)	Referencia	Color	NA	NC	P.V.P.
		NP2-BR11	○	1	-	11,70€
		NP2-BR21	●	1	-	11,70€
		NP2-BR31	●	1	-	11,70€
		NP2-BR41	●	1	-	11,70€
		NP2-BR51	●	1	-	11,70€
		NP2-BR61	●	1	-	11,70€
		NP2-BR12	○	-	1	11,70€
		NP2-BR22	●	-	1	11,70€
		NP2-BR32	●	-	1	11,70€
		NP2-BR42	●	-	1	11,70€
		NP2-BR52	●	-	1	11,70€
		NP2-BR62	●	-	1	11,70€
		NP2-BR13	○	2	-	14,40€
		NP2-BR23	●	2	-	14,40€
		NP2-BR33	●	2	-	14,40€
		NP2-BR43	●	2	-	14,40€
		NP2-BR53	●	2	-	14,40€
		NP2-BR63	●	2	-	14,40€
		NP2-BR14	○	-	2	14,40€
		NP2-BR24	●	-	2	14,40€
		NP2-BR34	●	-	2	14,40€
		NP2-BR44	●	-	2	14,40€
		NP2-BR54	●	-	2	14,40€
		NP2-BR64	●	-	2	14,40€
		NP2-BR15	○	1	1	14,40€
		NP2-BR25	●	1	1	14,40€
		NP2-BR35	●	1	1	14,40€
		NP2-BR45	●	1	1	14,40€
		NP2-BR55	●	1	1	14,40€
		NP2-BR65	●	1	1	14,40€







Pulsadores de plástico, tipo seta - Girar para desbloquear



F1	NP2-BS(**)	Diámetro seta	Referencia	Color	NA	NC	P.V.P.
		30mm	NP2-BS441	●	1	-	21,50€
			NP2-BS442		-	1	21,50€
		40mm	NP2-BS541	●	1	-	22,70€
			NP2-BS542		-	1	22,70€
		60mm	NP2-BS641	●	1	-	23,70€
			NP2-BS642		-	1	23,70€
		30mm	NP2-BS443	●	2	-	24,30€
			NP2-BS444		-	2	24,30€
			NP2-BS445		1	1	24,30€
		40mm	NP2-BS543	●	2	-	25,50€
			NP2-BS544		-	2	25,50€
			NP2-BS545		1	1	25,50€
		60mm	NP2-BS643	●	2	-	26,50€
			NP2-BS644		-	2	26,50€
			NP2-BS645		1	1	26,50€





Pilotos de plástico y metálicos - Conexión directa y con transformador

F1	NP2-EV(**)	Lámparas	Referencia	Color	P.V.P.
	LED corriente alterna Sustituir (*) por la tensión de la lámpara 6V, 12V, 24V,36V, 48V, 110V, 230V	NP2-EV61/L/(*)	○	8,90€	
		NP2-EV63/L/(*)	●	8,90€	
		NP2-EV64/L/(*)	●	8,90€	
		NP2-EV65/L/(*)	●	8,90€	
		NP2-EV66/L/(*)	●	8,90€	
	LED 6V Corriente alterna con TRANSFORMADOR: 230V	NP2-EV41/L/230	○	23,90€	
		NP2-EV43/L/230	●	23,90€	
		NP2-EV44/L/230	●	23,90€	
		NP2-EV45/L/230	●	23,90€	
		NP2-EV46/L/230	●	23,90€	
	LED 6V Corriente alterna con TRANSFORMADOR: 400V	NP2-EV51/L/400	○	23,90€	
		NP2-EV53/L/400	●	23,90€	
		NP2-EV54/L/400	●	23,90€	
		NP2-EV55/L/400	●	23,90€	
		NP2-EV56/L/400	●	23,90€	
	LED corriente alterna Sustituir (*) por la tensión de la lámpara 6V, 12V, 24V,36V, 48V, 110V, 230V	NP2-BV61/L/(*)	○	9,50€	
		NP2-BV63/L/(*)	●	9,50€	
		NP2-BV64/L/(*)	●	9,50€	
		NP2-BV65/L/(*)	●	9,50€	
		NP2-BV66/L/(*)	●	9,50€	
	LED 6V Corriente alterna con TRANSFORMADOR: 230V	NP2-BV41/L/230	○	27,40€	
		NP2-BV43/L/230	●	27,40€	
		NP2-BV44/L/230	●	27,40€	
		NP2-BV45/L/230	●	27,40€	
		NP2-BV46/L/230	●	27,40€	
	LED 6V Corriente alterna con TRANSFORMADOR: 400V	NP2-BV51/L/400	○	27,40€	
		NP2-BV53/L/400	●	27,40€	
		NP2-BV54/L/400	●	27,40€	
		NP2-BV55/L/400	●	27,40€	
		NP2-BV56/L/400	●	27,40€	

Pilotos cabeza saliente abombada - con resistencia

F1	ND16-22	Lámparas	Referencia	Color	P.V.P.
	LED Vca/Vcc Sustituir (*) por la tensión de la lámpara: 6V,12V,24V,36V,48V, 110V,230,400V	ND16-22D/2/W/(*)	○	5,90€	
		ND16-22D/2/G/(*)	●	5,90€	
		ND16-22D/2/R/(*)	●	5,90€	
		ND16-22D/2/B/(*)	●	5,90€	
		ND16-22D/2/Y/(*)	●	5,90€	
LED corriente alterna 230V, 400V (uso en equipos de condensadores)	ND16-22D/2F/W/(*)	○	5,90€		
	ND16-22D/2F/G/(*)	●	5,90€		
	ND16-22D/2F/R/(*)	●	5,90€		
	ND16-22D/2F/B/(*)	●	5,90€		
	ND16-22D/2F/Y/(*)	●	5,90€		
	LED Vca/Vcc Sustituir (*) por la tensión de la lámpara: 6V,12V,24V, 36V,48V	ND16-22DS/2/W/(*)	○	5,90€	
		ND16-22DS/2/G/(*)	●	5,90€	
		ND16-22DS/2/R/(*)	●	5,90€	
		ND16-22DS/2/B/(*)	●	5,90€	
		ND16-22DS/2/Y/(*)	●	5,90€	

Pilotos cabeza saliente abombada - con condensador

F1	ND16-22	Lámparas	Referencia	Color	P.V.P.
	LED corriente alterna Sustituir (*) por la tensión de la lámpara: 110V,230,400V	ND16-22D/4/W/(*)	○	5,90€	
		ND16-22D/4/G/(*)	●	5,90€	
		ND16-22D/4/R/(*)	●	5,90€	
		ND16-22D/4/B/(*)	●	5,90€	
		ND16-22D/4/Y/(*)	●	5,90€	
	LED Vca/Vcc Sustituir (*) por la tensión de la lámpara: 6,12,24, 36,48V	ND16-22DS/4/W/(*)	○	5,90€	
		ND16-22DS/4/G/(*)	●	5,90€	
		ND16-22DS/4/R/(*)	●	5,90€	
		ND16-22DS/4/B/(*)	●	5,90€	
		ND16-22DS/4/Y/(*)	●	5,90€	



ND16

Pilotos compactos (Diámetro: 22mm)



Pilotos cabeza plana - con resistencia

F1	ND16-22	Lámparas	Referencia	Color	P.V.P.
	LED Vca/Vcc Sustituir (*) por la tensión de la lámpara: 6V,12V,24V,36V,48V, 110V,230,400V	ND16-22A/2/W/(*).	○	5,90€	
		ND16-22A/2/G/(*).	●	5,90€	
		ND16-22A/2/R/(*).	●	5,90€	
		ND16-22A/2/B/(*).	●	5,90€	
		ND16-22A/2/Y/(*).	●	5,90€	
	LED corriente alterna 230V, 400V (uso en equipos de condensadores)	ND16-22A/2F/W/(*).	○	5,90€	
		ND16-22A/2F/G/(*).	●	5,90€	
		ND16-22A/2F/R/(*).	●	5,90€	
		ND16-22A/2F/B/(*).	●	5,90€	
		ND16-22A/2F/Y/(*).	●	5,90€	
	LED Vca/Vcc Sustituir (*) por la tensión de la lámpara: 6V,12V,24V, 36V,48V	ND16-22AS/2/W/(*).	○	5,90€	
	ND16-22AS/2/G/(*).	●	5,90€		
	ND16-22AS/2/R/(*).	●	5,90€		
	ND16-22AS/2/B/(*).	●	5,90€		
	ND16-22AS/2/Y/(*).	●	5,90€		



Pilotos cabeza saliente plana - con resistencia

F1	ND16-22	Lámparas	Referencia	Color	P.V.P.
	LED Vca/Vcc Sustituir (*) por la tensión de la lámpara: 6V,12V,24V,36V,48V, 110V,230,400V	ND16-22B/2/W/(*).	○	5,90€	
		ND16-22B/2/G/(*).	●	5,90€	
		ND16-22B/2/R/(*).	●	5,90€	
		ND16-22B/2/B/(*).	●	5,90€	
		ND16-22B/2/Y/(*).	●	5,90€	
	LED corriente alterna 230V, 400V (uso en equipos de condensadores)	ND16-22B/2F/W/(*).	○	5,90€	
		ND16-22B/2F/G/(*).	●	5,90€	
		ND16-22B/2F/R/(*).	●	5,90€	
		ND16-22B/2F/B/(*).	●	5,90€	
		ND16-22B/2F/Y/(*).	●	5,90€	
	LED Vca/Vcc Sustituir (*) por la tensión de la lámpara: 6V,12V,24V, 36V,48V	ND16-22BS/2/W/(*).	○	5,90€	
	ND16-22BS/2/G/(*).	●	5,90€		
	ND16-22BS/2/R/(*).	●	5,90€		
	ND16-22BS/2/B/(*).	●	5,90€		
	ND16-22BS/2/Y/(*).	●	5,90€		



Pilotos cabeza plana - con condensador

F1	ND16-22	Lámparas	Referencia	Color	P.V.P.
	LED corriente alterna Sustituir (*) por la tensión de la lámpara: 110V,230,400V	ND16-22A/4/W/(*).	○	5,90€	
		ND16-22A/4/G/(*).	●	5,90€	
		ND16-22A/4/R/(*).	●	5,90€	
		ND16-22A/4/B/(*).	●	5,90€	
		ND16-22A/4/Y/(*).	●	5,90€	
	LED Vca/Vcc Sustituir (*) por la tensión de la lámpara: 6,12,24, 36,48V	ND16-22AS/4/W/(*).	○	5,90€	
	ND16-22AS/4/G/(*).	●	5,90€		
	ND16-22AS/4/R/(*).	●	5,90€		
	ND16-22AS/4/B/(*).	●	5,90€		
	ND16-22AS/4/Y/(*).	●	5,90€		



Pilotos cabeza saliente plana - con condensador

F1	ND16-22	Lámparas	Referencia	Color	P.V.P.
	LED corriente alterna Sustituir (*) por la tensión de la lámpara: 110V,230,400V	ND16-22B/4/W/(*).	○	5,90€	
		ND16-22B/4/G/(*).	●	5,90€	
		ND16-22B/4/R/(*).	●	5,90€	
		ND16-22B/4/B/(*).	●	5,90€	
		ND16-22B/4/Y/(*).	●	5,90€	
	LED Vca/Vcc Sustituir (*) por la tensión de la lámpara: 6,12,24, 36,48V	ND16-22BS/4/W/(*).	○	5,90€	
	ND16-22BS/4/G/(*).	●	5,90€		
	ND16-22BS/4/R/(*).	●	5,90€		
	ND16-22BS/4/B/(*).	●	5,90€		
	ND16-22BS/4/Y/(*).	●	5,90€		



Pilotos cabeza saliente abombada - con resistencia

F1	ND16-22	Lámparas	Referencia	Color	P.V.P.
	LED Vca/Vcc Sustituir (*) por la tensión de la lámpara: 6V,12V,24V,36V,48V, 110V,230,400V	ND16-22C/2/W/(*).	○	5,90€	
		ND16-22C/2/G/(*).	●	5,90€	
		ND16-22C/2/R/(*).	●	5,90€	
		ND16-22C/2/B/(*).	●	5,90€	
		ND16-22C/2/Y/(*).	●	5,90€	
	LED corriente alterna 230V, 400V (uso en equipos de condensadores)	ND16-22C/2F/W/(*).	○	5,90€	
		ND16-22C/2F/G/(*).	●	5,90€	
		ND16-22C/2F/R/(*).	●	5,90€	
		ND16-22C/2F/B/(*).	●	5,90€	
		ND16-22C/2F/Y/(*).	●	5,90€	
	LED Vca/Vcc Sustituir (*) por la tensión de la lámpara: 6V,12V,24V, 36V,48V	ND16-22CS/2/W/(*).	○	5,90€	
	ND16-22CS/2/G/(*).	●	5,90€		
	ND16-22CS/2/R/(*).	●	5,90€		
	ND16-22CS/2/B/(*).	●	5,90€		
	ND16-22CS/2/Y/(*).	●	5,90€		

Pilotos cabeza saliente abombada - con condensador

F1	ND16-22	Lámparas	Referencia	Color	P.V.P.
	LED corriente alterna Sustituir (*) por la tensión de la lámpara: 110V,230,400V	ND16-22C/4/W/(*).	○	5,90€	
		ND16-22C/4/G/(*).	●	5,90€	
		ND16-22C/4/R/(*).	●	5,90€	
		ND16-22C/4/B/(*).	●	5,90€	
		ND16-22C/4/Y/(*).	●	5,90€	
	LED Vca/Vcc Sustituir (*) por la tensión de la lámpara: 6,12,24, 36,48V	ND16-22CS/4/W/(*).	○	5,90€	
	ND16-22CS/4/G/(*).	●	5,90€		
	ND16-22CS/4/R/(*).	●	5,90€		
	ND16-22CS/4/B/(*).	●	5,90€		
	ND16-22CS/4/Y/(*).	●	5,90€		

Selectores de plástico - 2 posiciones

F1	NP2-E*(**)	Referencia	Pos.	NA	NC	P.V.P.
	V	NP2-ED21	1	-	9,60€	
		NP2-ED22	-	1	9,60€	
		NP2-ED23	2	-	12,40€	
		NP2-ED24	-	2	12,40€	
		NP2-ED25	1	1	12,40€	
	A	NP2-ED41	1	-	11,70€	
		NP2-ED42	-	1	11,70€	
		NP2-ED43	2	-	14,50€	
		NP2-ED44	-	2	14,50€	
		NP2-ED45	1	1	14,50€	
	V	NP2-EJ21	1	-	15,10€	
		NP2-EJ22	-	1	15,10€	
		NP2-EJ23	2	-	17,90€	
		NP2-EJ24	-	2	17,90€	
		NP2-EJ25	1	1	17,90€	
	A	NP2-EJ41	1	-	15,70€	
		NP2-EJ42	-	1	15,70€	
		NP2-EJ43	2	-	18,50€	
		NP2-EJ44	-	2	18,50€	
		NP2-EJ45	1	1	18,50€	
	V	NP2-EG21	1	-	28,40€	
		NP2-EG22	-	1	28,40€	
		NP2-EG23	2	-	31,20€	
		NP2-EG24	-	2	31,20€	
		NP2-EG25	1	1	31,20€	
	A	NP2-EG21B	1	-	30,40€	
		NP2-EG22B	-	1	30,40€	
		NP2-EG23B	2	-	33,20€	
		NP2-EG24B	-	2	33,20€	
		NP2-EG25B	1	1	33,20€	
	A	NP2-EG41	1	-	31,60€	
		NP2-EG42	-	1	31,60€	
		NP2-EG43	2	-	34,40€	
		NP2-EG44	-	2	34,40€	
		NP2-EG45	1	1	34,40€	

Selectores de plástico - 3 posiciones



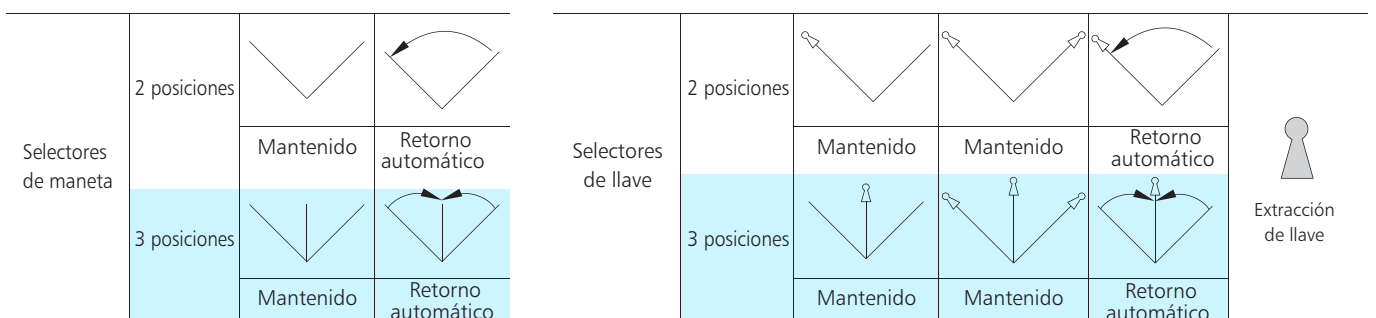

F1	NP2-E*(**)	Referencia	Pos.	NA	NC	P.V.P.
	V	NP2-ED31	1	-	9,70€	
		NP2-ED32	-	1	9,70€	
		NP2-ED33	2	-	12,40€	
		NP2-ED34	-	2	12,40€	
		NP2-ED35	1	1	12,40€	
	A	NP2-ED51	1	-	11,90€	
		NP2-ED52	-	1	11,90€	
		NP2-ED53	2	-	14,60€	
		NP2-ED54	-	2	14,60€	
		NP2-ED55	1	1	14,60€	
	V	NP2-EJ31	1	-	15,70€	
		NP2-EJ32	-	1	15,70€	
		NP2-EJ33	2	-	18,40€	
		NP2-EJ34	-	2	18,40€	
		NP2-EJ35	1	1	18,40€	
	A	NP2-EJ51	1	-	16,30€	
		NP2-EJ52	-	1	16,30€	
		NP2-EJ53	2	-	19,10€	
		NP2-EJ54	-	2	19,10€	
		NP2-EJ55	1	1	19,10€	
	V	NP2-EG31	1	-	32,10€	
		NP2-EG32	-	1	32,10€	
		NP2-EG33	2	-	34,90€	
		NP2-EG34	-	2	34,90€	
		NP2-EG35	1	1	34,90€	
	A	NP2-EG51	1	-	31,40€	
		NP2-EG52	-	1	31,40€	
		NP2-EG53	2	-	34,20€	
		NP2-EG54	-	2	34,20€	
		NP2-EG55	1	1	34,20€	
	A	NP2-EG3B1D	1	-	33,20€	
		NP2-EG3B2D	-	1	33,20€	
		NP2-EG3B3D	2	-	36,00€	
		NP2-EG3B4D	-	2	36,00€	
		NP2-EG3B5D	1	1	36,00€	



Selectores metálicos - 2 posiciones

F1	NP2-B*(**)	Referencia	Pos.	NA	NC	P.V.P.	
		NP2-BD21	∨	1	-	11,30€	
		NP2-BD22		-	1	11,30€	
		NP2-BD23		2	-	14,05€	
		NP2-BD24		-	2	14,05€	
		NP2-BD25		1	1	14,05€	
			NP2-BD41	↙	1	-	13,50€
			NP2-BD42		-	1	13,50€
			NP2-BD43		2	-	16,30€
			NP2-BD44		-	2	16,30€
			NP2-BD45		1	1	16,30€
		NP2-BJ21	∨		1	-	15,80€
	NP2-BJ22	-		1	15,80€		
	NP2-BJ23	2		-	18,60€		
	NP2-BJ24	-		2	18,60€		
	NP2-BJ25	1		1	18,60€		
		NP2-BJ41	↙	1	-	16,20€	
		NP2-BJ42		-	1	16,20€	
		NP2-BJ43		2	-	19,00€	
		NP2-BJ44		-	2	19,00€	
		NP2-BJ45		1	1	19,00€	
		NP2-BG21		∨	1	-	31,10€
		NP2-BG22	-		1	31,10€	
		NP2-BG23	2		-	33,90€	
		NP2-BG24	-		2	33,90€	
		NP2-BG25	1		1	33,90€	
			NP2-BG21B	∨	1	-	32,90€
			NP2-BG22B		-	1	32,90€
			NP2-BG23B		2	-	35,70€
			NP2-BG24B		-	2	35,70€
			NP2-BG25B		1	1	35,70€
		NP2-BG41	↙	1	-	34,20€	
		NP2-BG42		-	1	34,20€	
		NP2-BG43		2	-	37,00€	
		NP2-BG44		-	2	37,00€	
		NP2-BG45		1	1	37,00€	

Selectores metálicos - 3 posiciones

F1	NP2-B*(**)	Referencia	Pos.	NA	NC	P.V.P.	
		NP2-BD31	∨	1	-	11,40€	
		NP2-BD32		-	1	11,40€	
		NP2-BD33		2	-	14,10€	
		NP2-BD34		-	2	14,10€	
		NP2-BD35		1	1	14,10€	
			NP2-BD51	↙	1	-	13,10€
			NP2-BD52		-	1	13,10€
			NP2-BD53		2	-	15,80€
			NP2-BD54		-	2	15,80€
			NP2-BD55		1	1	15,80€
		NP2-BJ31	∨		1	-	16,80€
	NP2-BJ32	-		1	16,80€		
	NP2-BJ33	2		-	19,60€		
	NP2-BJ34	-		2	19,60€		
	NP2-BJ35	1		1	19,60€		
		NP2-BJ51	↙	1	-	20,70€	
		NP2-BJ52		-	1	20,70€	
		NP2-BJ53		2	-	23,40€	
		NP2-BJ54		-	2	23,40€	
		NP2-BJ55		1	1	23,40€	
		NP2-BG31		∨	1	-	33,50€
		NP2-BG32	-		1	33,50€	
		NP2-BG33	2		-	36,20€	
		NP2-BG34	-		2	36,20€	
		NP2-BG35	1		1	36,20€	
			NP2-BG51	↙	1	-	34,40€
			NP2-BG52		-	1	34,40€
			NP2-BG53		2	-	37,10€
			NP2-BG54		-	2	37,10€
			NP2-BG55		1	1	37,10€
		NP2-BG3B1D	↙	1	-	36,80€	
		NP2-BG3B2D		-	1	36,80€	
		NP2-BG3B3D		2	-	39,60€	
		NP2-BG3B4D		-	2	39,60€	
		NP2-BG3B5D		1	1	39,60€	

Cajas vacías y Cajas equipadas - 1 elem.

F1	Fotografía	Referencia	P.V.P.
		NP2-B01	9,40€
		NP2-B02	13,30€
		NP2-B03	16,30€
		NP2-J01	9,40€
		NP2-B101H29	15,80€
		NP2-B102	15,90€
		NP2-B103	15,90€
		NP2-B111H29	15,80€



Cajas equipadas - 1 elemento

F1	Fotografía	Referencia	P.V.P.
		NP2-B112	15,90€
		NP2-B114	15,90€
		NP2-B132H29	19,00€
		NP2-B142H29	37,80€
		NP2-B164H29	18,70€
		NP2-J174	27,50€
		NP2-J174H29	27,50€

Cajas equipadas - 2 elementos

F1	Fotografía	Referencia	P.V.P.
		NP2-B211H29	26,00€
		NP2-B213	26,20€
		NP2-B215	26,20€
		NP2-B222	26,20€
		NP2-B223	26,20€

Cajas equipadas - 3 elementos

F1	Fotografía	Referencia	P.V.P.
		NP2-B311H29 (Avance, Parada, Retroceso)	54,40€
		NP2-B321H29 (Arriba, Parada, Abajo)	54,40€
		NP2-B324	55,00€

Cajas equipadas - 3 elementos

F1	Fotografía	Referencia	P.V.P.
		NP2-B363	35,10€
		NP2-B366	35,10€

Cajas equipadas - 3 elementos

F1	Fotografía	Referencia	P.V.P.
		NP2-B334	55,00€
		NP2-B339	55,00€
		NP2-B341H29 (Cierre, Parada, Apertura)	54,40€
		NP2-B361H29 (Parada, Arranque)	54,40€

Etiquetas adhesivas - Emergencia

F1	NP2-BY	Referencia	Características	P.V.P.
		NP2-BY9101	60mm diam. sin grabación	7,20€
		NP2-BY9330	60mm diam. "Parada Emergencia"	7,40€
		NP2-BY8101	90mm diam. sin grabación	8,20€
		NP2-BY8330	90mm diam. "Parada Emergencia"	8,40€

Protectores de pulsadores

F1	NP2-BX	Referencia	Grado de protección	P.V.P.
   		NP2-BX01	IP65	2,30€
		NP2-BX02	IP65	2,30€
		NP2-BX03	IP65	2,30€
		NP2-BX04	IP65	2,50€

Lámparas LED - 6,12,24,36Vca/Vcc

F1	LED	Referencia	Color	P.V.P.
		LED(*)W		16,50€
		LED(*)G		16,50€
		LED(*)R		16,50€
		LED(*)Y		16,50€
		LED(*)B		16,50€

Sustituir (*) por la tensión de LED deseada: 6, 12, 24, 48, 110, 230Vca/Vcc

Portaetiquetas y etiquetas

F1	NP2-BY	Referencia	Características	P.V.P.
		NP2-BZ31	Porta-etiquetas 30x45mm	2,30€
		NP2-BZ00	Etiqueta sin grabación	2,30€
		NP2-BZ**	Etiqueta grabada	14,00€

Contactos (montaje en el pulsador)

F1	NP2-BE	Referencia	Descripción	P.V.P.
		NP2-BE101	1NA	2,80€
		NP2-BE102	1NC	2,80€









Contactos (montaje a fondo de caja)

F1	NP2-BE	Referencia	Descripción	P.V.P.
		NP2-L1111	1NA	2,80€
		NP2-L1121	1NC	2,80€

Bases para pulsadores luminosos (sin lámpara)

F1	NP2-EW	Referencia	Descripción	P.V.P.
		NP2-EW6/EV6	Directo	3,80€
		NP2-EW4/EV4 NP2-EW5/EV5	Transform. 220Vca 400Vca	6,80€

Zumbadores compactos - diametro 22mm

F1	ND16	Tensión	Referencia	Color	P.V.P.
	Sonido intermitente		ND16-22F/B/(*)		29,30€
			ND16-22F/R/(*)		29,30€
	Sonido continuo		ND16-22L/B/(*)		29,30€
			ND16-22L/R/(*)		29,30€
	Sonido intermitente, rasante		ND16-22FS/B/(*)		29,30€
			NFM1-22FS/R/(*)		29,30€
	Sonido continuo, con piloto		ND16-22LC/B/(*)		29,30€
			ND16-22LC/R/(*)		29,30€

Sustituir (*) por la tensión requerida: 24Vca/Vcc, 110, 230, 400Vca



NP6
Auxiliares de mando (Diámetro: 16mm)







Pulsadores rasantes momentáneos

F1	NP6-11/22B/*	Referencia	Color	⌋	P.V.P.
	NP6-11B	NP6-11B/1J	○	1	16,50€
		NP6-11B/2J	●	1	16,50€
		NP6-11B/3J	●	1	16,50€
		NP6-11B/4J	●	1	16,50€
		NP6-11B/5J	●	1	16,50€
		NP6-11B/6J	●	1	16,50€
		NP6-11B/7J	●	1	16,50€
	NP6-22B	NP6-22B/1J	○	2	19,80€
		NP6-22B/2J	●	2	19,80€
		NP6-22B/3J	●	2	19,80€
		NP6-22B/4J	●	2	19,80€
		NP6-22B/5J	●	2	19,80€
		NP6-22B/6J	●	2	19,80€
		NP6-22B/7J	●	2	19,80€
	NP6-11B	NP6-11B/1F	○	1	16,50€
		NP6-11B/2F	●	1	16,50€
		NP6-11B/3F	●	1	16,50€
		NP6-11B/4F	●	1	16,50€
		NP6-11B/5F	●	1	16,50€
		NP6-11B/6F	●	1	16,50€
		NP6-11B/7F	●	1	16,50€
	NP6-22B	NP6-22B/1F	○	2	19,80€
		NP6-22B/2F	●	2	19,80€
		NP6-22B/3F	●	2	19,80€
		NP6-22B/4F	●	2	19,80€
		NP6-22B/5F	●	2	19,80€
		NP6-22B/6F	●	2	19,80€
		NP6-22B/7F	●	2	19,80€
	NP6-11B	NP6-11B/1Y	○	1	16,50€
		NP6-11B/2Y	●	1	16,50€
		NP6-11B/3Y	●	1	16,50€
		NP6-11B/4Y	●	1	16,50€
		NP6-11B/5Y	●	1	16,50€
		NP6-11B/6Y	●	1	16,50€
		NP6-11B/7Y	●	1	16,50€
	NP6-22B	NP6-22B/1Y	○	2	19,80€
		NP6-22B/2Y	●	2	19,80€
		NP6-22B/3Y	●	2	19,80€
		NP6-22B/4Y	●	2	19,80€
		NP6-22B/5Y	●	2	19,80€
		NP6-22B/6Y	●	2	19,80€
		NP6-22B/7Y	●	2	19,80€

Pulsadores rasantes mantenidos







F1	NP6-11/22BS/*	Referencia	Color	⌋	P.V.P.
	NP6-11BS	NP6-11BS/1J	○	1	16,50€
		NP6-11BS/2J	●	1	16,50€
		NP6-11BS/3J	●	1	16,50€
		NP6-11BS/4J	●	1	16,50€
		NP6-11BS/5J	●	1	16,50€
		NP6-11BS/6J	●	1	16,50€
		NP6-11BS/7J	●	1	16,50€
	NP6-22BS	NP6-22BS/1J	○	2	19,80€
		NP6-22BS/2J	●	2	19,80€
		NP6-22BS/3J	●	2	19,80€
		NP6-22BS/4J	●	2	19,80€
		NP6-22BS/5J	●	2	19,80€
		NP6-22BS/6J	●	2	19,80€
		NP6-22BS/7J	●	2	19,80€
	NP6-11BS	NP6-11BS/1F	○	1	16,50€
		NP6-11BS/2F	●	1	16,50€
		NP6-11BS/3F	●	1	16,50€
		NP6-11BS/4F	●	1	16,50€
		NP6-11BS/5F	●	1	16,50€
		NP6-11BS/6F	●	1	16,50€
		NP6-11BS/7F	●	1	16,50€
	NP6-22BS	NP6-22BS/1F	○	2	19,80€
		NP6-22BS/2F	●	2	19,80€
		NP6-22BS/3F	●	2	19,80€
		NP6-22BS/4F	●	2	19,80€
		NP6-22BS/5F	●	2	19,80€
		NP6-22BS/6F	●	2	19,80€
		NP6-22BS/7F	●	2	19,80€
	NP6-11BS	NP6-11BS/1Y	○	1	16,50€
		NP6-11BS/2Y	●	1	16,50€
		NP6-11BS/3Y	●	1	16,50€
		NP6-11BS/4Y	●	1	16,50€
		NP6-11BS/5Y	●	1	16,50€
		NP6-11BS/6Y	●	1	16,50€
		NP6-11BS/7Y	●	1	16,50€
	NP6-22BS	NP6-22BS/1Y	○	2	19,80€
		NP6-22BS/2Y	●	2	19,80€
		NP6-22BS/3Y	●	2	19,80€
		NP6-22BS/4Y	●	2	19,80€
		NP6-22BS/5Y	●	2	19,80€
		NP6-22BS/6Y	●	2	19,80€
		NP6-22BS/7Y	●	2	19,80€

Pulsadores rasantes luminosos momentáneos

F1	NP6-11/22D/*	Referencia	Color	⌋	P.V.P.
		NP6-11D/1J/(*)	○	1	22,20€
		NP6-11D/2J/(*)	●	1	22,20€
		NP6-11D/3J/(*)	●	1	22,20€
		NP6-11D/4J/(*)	●	1	22,20€
		NP6-11D/5J/(*)	●	1	22,20€
		NP6-11D/6J/(*)	●	1	22,20€
		NP6-11D/7J/(*)	●	1	22,20€
		NP6-22D/1J/(*)	○	2	24,60€
		NP6-22D/2J/(*)	●	2	24,60€
		NP6-22D/3J/(*)	●	2	24,60€
		NP6-22D/4J/(*)	●	2	24,60€
		NP6-22D/5J/(*)	●	2	24,60€
		NP6-22D/6J/(*)	●	2	24,60€
		NP6-22D/7J/(*)	●	2	24,60€
		NP6-11D/1F/(*)	○	1	22,20€
		NP6-11D/2F/(*)	●	1	22,20€
		NP6-11D/3F/(*)	●	1	22,20€
		NP6-11D/4F/(*)	●	1	22,20€
		NP6-11D/5F/(*)	●	1	22,20€
		NP6-11D/6F/(*)	●	1	22,20€
		NP6-11D/7F/(*)	●	1	22,20€
		NP6-22D/1F/(*)	○	2	24,60€
		NP6-22D/2F/(*)	●	2	24,60€
		NP6-22D/3F/(*)	●	2	24,60€
		NP6-22D/4F/(*)	●	2	24,60€
		NP6-22D/5F/(*)	●	2	24,60€
		NP6-22D/6F/(*)	●	2	24,60€
		NP6-22D/7F/(*)	●	2	24,60€
		NP6-11D/1Y/(*)	○	1	22,20€
		NP6-11D/2Y/(*)	●	1	22,20€
		NP6-11D/3Y/(*)	●	1	22,20€
		NP6-11D/4Y/(*)	●	1	22,20€
		NP6-11D/5Y/(*)	●	1	22,20€
		NP6-11D/6Y/(*)	●	1	22,20€
		NP6-11D/7Y/(*)	●	1	22,20€
		NP6-22D/1Y/(*)	○	2	24,60€
		NP6-22D/2Y/(*)	●	2	24,60€
		NP6-22D/3Y/(*)	●	2	24,60€
		NP6-22D/4Y/(*)	●	2	24,60€
		NP6-22D/5Y/(*)	●	2	24,60€
		NP6-22D/6Y/(*)	●	2	24,60€
		NP6-22D/7Y/(*)	●	2	24,60€

Sustituir (*) por la tensión: 6, 12, 24Vca

Pulsadores rasantes luminosos mantenidos

F1	NP6-11/22DS/*	Referencia	Color	⌋	P.V.P.
		NP6-11DS/1J/(*)	○	1	22,20€
		NP6-11DS/2J/(*)	●	1	22,20€
		NP6-11DS/3J/(*)	●	1	22,20€
		NP6-11DS/4J/(*)	●	1	22,20€
		NP6-11DS/5J/(*)	●	1	22,20€
		NP6-11DS/6J/(*)	●	1	22,20€
		NP6-11DS/7J/(*)	●	1	22,20€
		NP6-22DS/1J/(*)	○	2	24,60€
		NP6-22DS/2J/(*)	●	2	24,60€
		NP6-22DS/3J/(*)	●	2	24,60€
		NP6-22DS/4J/(*)	●	2	24,60€
		NP6-22DS/5J/(*)	●	2	24,60€
		NP6-22DS/6J/(*)	●	2	24,60€
		NP6-22DS/7J/(*)	●	2	24,60€
		NP6-11DS/1F/(*)	○	1	22,20€
		NP6-11DS/2F/(*)	●	1	22,20€
		NP6-11DS/3F/(*)	●	1	22,20€
		NP6-11DS/4F/(*)	●	1	22,20€
		NP6-11DS/5F/(*)	●	1	22,20€
		NP6-11DS/6F/(*)	●	1	22,20€
		NP6-11DS/7F/(*)	●	1	22,20€
		NP6-22DS/1F/(*)	○	2	24,60€
		NP6-22DS/2F/(*)	●	2	24,60€
		NP6-22DS/3F/(*)	●	2	24,60€
		NP6-22DS/4F/(*)	●	2	24,60€
		NP6-22DS/5F/(*)	●	2	24,60€
		NP6-22DS/6F/(*)	●	2	24,60€
		NP6-22DS/7F/(*)	●	2	24,60€
		NP6-11DS/1Y/(*)	○	1	22,20€
		NP6-11DS/2Y/(*)	●	1	22,20€
		NP6-11DS/3Y/(*)	●	1	22,20€
		NP6-11DS/4Y/(*)	●	1	22,20€
		NP6-11DS/5Y/(*)	●	1	22,20€
		NP6-11DS/6Y/(*)	●	1	22,20€
		NP6-11DS/7Y/(*)	●	1	22,20€
		NP6-22DS/1Y/(*)	○	2	24,60€
		NP6-22DS/2Y/(*)	●	2	24,60€
		NP6-22DS/3Y/(*)	●	2	24,60€
		NP6-22DS/4Y/(*)	●	2	24,60€
		NP6-22DS/5Y/(*)	●	2	24,60€
		NP6-22DS/6Y/(*)	●	2	24,60€
		NP6-22DS/7Y/(*)	●	2	24,60€

Sustituir (*) por la tensión: 6, 12, 24Vca

Pulsadores de seta - Diam.23mm

F1	NP6-11/22J	Referencia	Color		P.V.P.
		NP6-11J/3		1	29,50€
		NP6-11J/4		1	29,50€
		NP6-11J/5		1	29,50€
		NP6-22J/3		2	35,40€
		NP6-22J/4		2	35,40€
		NP6-22J/5		2	35,40€

Pulsadores de seta - girar para desbloquear - Diam.23mm

F1	NP6-11/22ZS/4	Referencia	Color		P.V.P.
		NP6-11ZS/4		1	29,50€
		NP6-22ZS/4		2	35,40€

Pilotos

F1	NP6-XD	Referencia	Color	P.V.P.
		NP6-XD/1J/(*)		13,50€
		NP6-XD/3J/(*)		13,50€
		NP6-XD/4J/(*)		13,50€
		NP6-XD/5J/(*)		13,50€
		NP6-XD/6J/(*)		13,50€
		NP6-XD/7J/(*)		13,50€
			NP6-XD/1F/(*)	
		NP6-XD/3F/(*)		13,50€
		NP6-XD/4F/(*)		13,50€
		NP6-XD/5F/(*)		13,50€
		NP6-XD/6F/(*)		13,50€
		NP6-XD/7F/(*)		13,50€
			NP6-XD/1Y/(*)	
		NP6-XD/3Y/(*)		13,50€
		NP6-XD/4Y/(*)		13,50€
		NP6-XD/5Y/(*)		13,50€
		NP6-XD/6Y/(*)		13,50€
		NP6-XD/7Y/(*)		13,50€

Sustituir (*) por la tensión: 6,12,24Vca

Selectores de maneta

F1	NP6-11/22X	Referencia	Posiciones		P.V.P.
		NP6-11X/2Y		1	35,20€
		NP6-22X/2Y		2	39,90€
		NP6-22X/3Y		2	44,70€

Selectores con llave

F1	NP6-11/22Y	Referencia	Posiciones		P.V.P.
		NP6-11Y/2J		1	59,80€
		NP6-22Y/2J		2	67,50€
		NP6-22Y/3J		2	72,90€
		NP6-11Y/2F		1	59,80€
		NP6-22Y/2F		2	67,50€
		NP6-22Y/3F		2	72,90€
		NP6-11Y/2Y		1	59,80€
		NP6-22Y/2Y		2	67,50€
		NP6-22Y/3Y		2	72,90€







NP3

Botoneras colgantes

Pulsadores rasantes momentáneos
con pulsador de arranque ON mantenido





Pulsadores rasantes momentáneos





F1	NP3-*	Refer.	Función	P.V.P.
	NP3-1		ARRIBA ABAJO	35,00€
	NP3-2		ARRIBA/IZQUIERDA ABAJO/DERECHA	51,90€
	NP3-3		ARRIBA/IZQUIERDA/ADELANTE ABAJO/DERECHA/ATRÁS	68,70€
	NP3-4		ARRIBA/IZQUIERDA/ADELANTE/ en sentido antihorario ABAJO/DERECHA/ATRÁS/ en sentido horario	91,20€
	NP3-5		ARRIBA/IZQUIERDA/ADELANTE/ en sentido antihorario/RÁPIDO ABAJO/DERECHA/ATRÁS/ en sentido horario/DESPACIO	112,35€

F1	NP3-*A	Refer.	Función	P.V.P.
	NP3-1A		(on/off) ARRIBA ABAJO	40,70€
	NP3-2A		(on/off) ARRIBA/IZQUIERDA ABAJO/DERECHA	57,50€
	NP3-3A		(on/off) ARRIBA/IZQUIERDA/ADELANTE ABAJO/DERECHA/ATRÁS	74,30€
	NP3-4A		(on/off) ARRIBA/IZQUIERDA/ADELANTE/ en sentido antihorario ABAJO/DERECHA/ATRÁS/ en sentido horario	96,80€

Pulsadores rasantes momentáneos - con pulsador de arranque (ON)
mantenido y pulsador de paro (OFF) de tipo seta

Pulsadores rasantes momentáneos - con interruptores (ON/OFF)

F1	NP3-*B	Refer.	Función	P.V.P.
	NP3-1B		(on/off) ARRIBA ABAJO	40,70€
	NP3-2B		(on/off) ARRIBA/IZQUIERDA ABAJO/DERECHA	57,50€
	NP3-3B		(on/off) ARRIBA/IZQUIERDA/ADELANTE ABAJO/DERECHA/ATRÁS	74,30€
	NP3-4B		(on/off) ARRIBA/IZQUIERDA/ADELANTE/ en sentido antihorario ABAJO/DERECHA/ATRÁS/ en sentido horario	96,80€

F1	NP3-*K	Refer.	Función	P.V.P.
	NP3-1K		(on/off) ARRIBA ABAJO	61,70€
	NP3-2K		(on/off) ARRIBA/IZQUIERDA ABAJO/DERECHA	78,50€
	NP3-3K		(on/off) ARRIBA/IZQUIERDA/ADELANTE ABAJO/DERECHA/ATRÁS	95,30€
	NP3-4K		(on/off) ARRIBA/IZQUIERDA/ADELANTE/ en sentido antihorario ABAJO/DERECHA/ATRÁS/ en sentido horario	117,80€



RT Fusibles y Bases

RT28/RT29

Fusibles cilindricos - 2~125A (20kA)

Curva gG (estandar)



F2	Referencia	Dimensiones	Calibres (A)	Indicador de fusión	Embalaje	P.V.P.
	RT29-16/gG/(*)	8,5x31,5	2, 4, 6, 8, 10, 16	No	50	0,52€
	RT28-32/gG/(*)	10x38	2, 4, 6, 8, 10, 16, 20, 25,32	No	50	0,67€
	RT28-32/gG/(*)/IF	10x38	2, 4, 6, 8, 10, 16, 20, 25,32	Si	50	0,72€
	RT28-63/gG/(*)	14x51	10, 16, 20, 25,32, 40, 50, 63	No	50	0,97€
	RT28-63/gG/(*)/IF	14x51	10, 16, 20, 25,32, 40, 50, 63	Si	50	1,10€
	RT29-125/gG/(*)	22x58	25,32, 40, 50, 63, 80, 100, 125	No	50	2,50€

Curva aM (acompañamiento de motor)



F2	Referencia	Dimensiones	Calibres (A)	Indicador de fusión	Embalaje	P.V.P.
	RT29-16/aM/(*)	8,5x31,5	2, 4, 6, 8, 10, 16	No	50	0,52€
	RT28-32/aM/(*)	10x38	2, 4, 6, 8, 10, 16, 20, 25,32	No	50	0,67€
	RT28-32/aM/(*)/IF	10x38	2, 4, 6, 8, 10, 16, 20, 25,32	Si	50	0,72€
	RT28-63/aM/(*)	14x51	10, 16, 20, 25,32, 40, 50, 63	No	50	0,97€
	RT28-63/aM/(*)/IF	14x51	10, 16, 20, 25,32, 40, 50, 63	Si	50	1,10€
	RT29-125/aM/(*)	22x58	25,32, 40, 50, 63, 80, 100, 125	No	50	2,50€

Sustituir (*) por el calibre del fusible

WS18

Bases para fusibles cilindricos



F4	Referencia	Polos/Amperios	Para fusibles tipo...	Dimensiones	Embalaje	P.V.P.
	WS18-1/32	1P/32A	RT29-16 y RT28-32	18mm	12	3,70€
	WS18-1/63	1P/63A	RT28-63	26mm	12	6,40€
	WS18-1/125	1P/125A	RT29-125	35mm	6	12,40€
	WS18-2/32	2P/32A	RT29-16 y RT28-32	36mm	6	5,60€
	WS18-2/63	2P/63A	RT28-63	52mm	6	9,90€
	WS18-2/125	2P/125A	RT29-125	70mm	4	18,90€
	WS18-3/32	3P/32A	RT29-16 y RT28-32	54mm	4	9,00€
	WS18-3/63	3P/63A	RT28-63	104mm	4	15,00€
	WS18-3/125	3P/125A	RT29-125	140mm	2	28,00€

RT36

Fusibles TIPO NH - 4~1000A (120kA/500V)



F2	Referencia	Tamaño	Calibre (A)	Embalaje	P.V.P.
	RT36-00/(*)/(*)	T00	4,6,10,16,20,25,32,40,50,63,80	3	6,25€
	RT36-00/100/(*)	T00	100	3	6,25€
	RT36-00/125/(*)	T00	125	3	6,44€
	RT36-00/160/(*)	T00	160	3	6,44€
	RT36-0/(*)/(*)	T0	4,6,10,16,20,25,32,40,50,63,80	3	6,55€
	RT36-0/100/(*)	T0	100	3	6,75€
	RT36-0/125/(*)	T0	125	3	6,75€
	RT36-0/160/(*)	T0	160	3	6,75€
	RT36-1/(*)/(*)	T1	80,100,125	3	10,10€
	RT36-1/160/(*)	T1	160	3	11,50€
	RT36-1/200/(*)	T1	200	3	11,50€
	RT36-1/250/(*)	T1	250	3	11,50€
	RT36-2/(*)/(*)	T2	125,160,200,250	1	13,90€
	RT36-2/300/(*)	T2	300	1	15,15€
	RT36-2/315/(*)	T2	315	1	15,15€
	RT36-2/355/(*)	T2	355	1	15,15€
	RT36-2/400/(*)	T2	400	1	15,15€
	RT36-3/(*)/(*)	T3	315,355	1	22,25€
	RT36-3/400/(*)	T3	400	1	22,25€
	RT36-3/500/(*)	T3	500	1	23,60€
	RT36-3/630/(*)	T3	630	1	25,40€
	RT36-4/800/(*)	T4	800	1	104,90€
	RT36-4/1000/(*)	T4	1000	1	116,70€

RT36-(*)/(*)/(*)

Composición de la referencia para pedidos

Tipo de curva:

- gM - Protección estandar
- aM - Acompañamiento de motor

Calibre del fusible

Tamaño del fusible

Serie



F2	Referencia	Características de las bases	Embalaje	P.V.P.
	BRT36/00	Base portafusible - Unipolar - Tamaño 00 - 160A	3	6,00€
	BRT36/0	Base portafusible - Unipolar - Tamaño 0 - 160A	3	8,10€
	BRT36/1	Base portafusible - Unipolar - Tamaño 1 - 250A	3	16,30€
	BRT36/2	Base portafusible - Unipolar - Tamaño 2 - 400A	3	18,50€
	BRT36/3	Base portafusible - Unipolar - Tamaño 3 - 630A	3	30,80€
	BRT36/4	Base portafusible - Unipolar - Tamaño 4 - 1000A	3	170,90€



F2	Referencia	Características de las bases	Embalaje	P.V.P.
	ERT36	Empuñadura extracción fusibles NH	1	17,50€



RELÉS

Relés enchufables - corriente alterna y continua

F3	JTX	Referencia	Contactos	In.	Embal.	P.V.P.
	CORRIENTE ALTERNA					
		JTX-2C/(*)CA	2NA/NC	10A	10	14,30€
		JTX-3C/(*)CA	3NA/NC	10A	10	16,20€
	CORRIENTE CONTINUA					
		JTX-2C/(*)CC	2NA/NC	10A	10	15,30€
	JTX-3C/(*)CC	3NA/NC	10A	10	17,20€	

Sustituir (*) por la tensión: 6,12,24,48,110,220,380Vca
Sustituir (*) por la tensión: 6,12,24,36,48,110,220Vcc

Relés enchufables - corriente alterna y continua

F3	JQX/F	Referencia	Contactos	In.	Embal.	P.V.P.
	CORRIENTE ALTERNA					
		JQX-10F/(*)CA-2Z	2NA/NC	10A	10	14,30€
		JQX-10F/(*)CA-3Z	3NA/NC	10A	10	16,20€
	CORRIENTE CONTINUA					
		JQX-10F/(*)CC-2Z	2NA/NC	10A	10	15,30€
	JQX-10F/(*)CC-3Z	3NA/NC	10A	10	17,20€	

Sustituir (*) por la tensión: 6,12,24,36,48,110,127,220,380Vca
Sustituir (*) por la tensión: 6,12,24,36,48,110,125,220Vcc

Bases para relés enchufables - corriente alterna y continua

F3	CZF	Referencia	Embal.	P.V.P.
	BASE ENCHUFABLE PARA JTX-2C			
		CZF08A-E 52x41x21,5mm - protegida	10	7,10€
	BASE ENCHUFABLE PARA JTX-3C			
		CZF11A-E 52x44x31mm - protegida	10	8,50€

Bases para relés enchufables - corriente alterna y continua

F3	JQX/F	Referencia	Embal.	P.V.P.
	BASE ENCHUFABLE PARA JQX-10F/2Z			
		CZF08A-E 52x41x21,5mm - protegida	10	7,10€
	BASE ENCHUFABLE PARA JQX-10F/3Z			
		CZF11A-E 52x44x31mm - protegida	10	8,50€

Relés corriente alterna - enchufables

F3	JQX 13F	Referencia	Contactos	In.	Embal.	P.V.P.
	CON INDICADOR					
		JQX-13F/D/(*)CA-2Z/6	2NA/NC	10A	10	14,30€

Sustituir (*) por la tensión: 6,12,24,36,48,110,127,220,380V

Relés corriente continua - enchufables

F3	JQX 13F	Referencia	Contactos	In.	Embal.	P.V.P.
	CON INDICADOR					
		JQX-13F/D/(*)CC-2Z/6	2NA/NC	10A	10	15,30€

Sustituir (*) por la tensión: 6,12,24,36,48,110,125,220V

Bases para relés enchufables - corriente alterna

F3	CZF	Referencia	Embal.	P.V.P.
	BASE ENCHUFABLE PARA JQX-13F			
		CZF08A-01E 68x30x28mm - protegida	10	7,10€

Bases para relés enchufables - corriente alterna

F3	JQX/F	Referencia	Embal.	P.V.P.
	BASE ENCHUFABLE PARA JQX-13F			
		CZF08A-01E 68x30x28mm - protegida	10	7,10€



RELÉS

Relés corriente alterna - enchufables

F3	JZX 22F	Referencia	Contactos	In.	Embal.	P.V.P.
	CON INDICADOR					
	JZX-22F/D/(*)CA-2ZS/6	2NA/NC	5A	10	5,65€	
	JZX-22F/D/(*)CA-3ZS/6	3NA/NC	5A	10	5,85€	
	JZX-22F/D/(*)CA-4ZS/6	4NA/NC	3A	10	6,15€	

Sustituir (*) por la tensión: 6,12,24,36,48,110,127,220,380V

Relés corriente continua - enchufables

F3	JZX 22F	Referencia	Contactos	In.	Embal.	P.V.P.
	CON INDICADOR					
	JZX-22F/D/(*)CC-2ZS/6	2NA/NC	5A	10	5,65€	
	JZX-22F/D/(*)CC-3ZS/6	3NA/NC	5A	10	5,85€	
	JZX-22F/D/(*)CC-4ZS/6	4NA/NC	3A	10	6,15€	

Sustituir (*) por la tensión: 6,12,24,36,48,110,125,220V

Bases para relés enchufables - corriente alterna

F3	CZy	Referencia	Embal.	P.V.P.
	BASES ENCHUFABLE PARA JZX-22F			
	CZY08B-01E - 2 contactos 63x30,5x26mm - protegida	10	6,50€	
	CZY11B-01E - 3 contactos 72x30x31mm - protegida	10	7,30€	
	CZY14B-01E - 4 contactos 63x30,5x26mm - protegida	10	8,10€	

Bases para relés enchufables - corriente continua

F3	CZY	Referencia	Embal.	P.V.P.
	BASES ENCHUFABLE PARA JZX-22F			
	CZY08B-01E - 2 contactos 63x30,5x26mm - protegida	10	6,50€	
	CZY11B-01E - 3 contactos 72x30x31mm - protegida	10	7,30€	
	CZY14B-01E - 4 contactos 63x30,5x26mm - protegida	10	8,10€	

Relés corriente alterna - para circuito impreso

F3	JZX 22F	Referencia	Contactos	In.	Embal.	P.V.P.
	CON INDICADOR					
	JZX-22F/D/(*)CA-2ZS/1	2NA/NC	5A	10	5,65€	
	JZX-22F/D/(*)CA-3ZS/1	3NA/NC	5A	10	5,85€	
	JZX-22F/D/(*)CA-4ZS/1	4NA/NC	3A	10	6,50€	

Sustituir (*) por la tensión: 6,12,24,36,48,110,127,220,380V

Relés corriente continua - para circuito impreso

F3	JZX 22F	Referencia	Contactos	In.	Embal.	P.V.P.
	CON INDICADOR					
	JZX-22F/D/(*)CC-2ZS/1	2NA/NC	5A	10	5,65€	
	JZX-22F/D/(*)CC-3ZS/1	3NA/NC	5A	10	5,85€	
	JZX-22F/D/(*)CC-4ZS/1	4NA/NC	3A	10	6,50€	

Sustituir (*) por la tensión: 6,12,24,36,48,110,127,220V



RELÉS

Relés Sub - corriente alterna y continua

F3	JQC-3F	Referencia	Contactos	In.	Embal.	P.V.P.
	CORRIENTE ALTERNA					
	JQC-3F/(*)CA-1Z	1NA/NC	7A	10	4,65€	
	JQC-3F/(*)CA-1H	1NA	7A	10	4,10€	
	CORRIENTE CONTINUA					
	JQC-3F/(*)CC-1Z	1NA/NC	7A	10	4,65€	
JQC-3F/(*)CC-1H	1NA	7A	10	4,10€		

Sustituir (*) por la tensión: 3,6,9,12,24,48V



CORRECCIÓN DEL FACTOR DE POTENCIA

JKF8

Controlador para compensación de Energía Reactiva en B.T.



F5	Referencia	Pasos	Tensión de control	Consumo de energía	Contactos de salida	P.V.P.
	JKF8-6	1~6	400Vca±10%	15W max.	5A/230V - 3A/400V	180,45€
	JKF8-12	1~12	400Vca±10%	15W max.	5A/230V - 3A/400V	216,90€

BZMJ

Condensadores de C.A. - paralelos autorregenerados



F4	Referencia	Tensión nominal kV	Capacidad nominal kVar	Frecuencia nominal Hz	Capacidad nominal μ F	Corriente nominal A	P.V.P.
	BZMJ-0.23-5-3	0.23	5	50	301	12.5	115,00€
	BZMJ-0.23-6-3	0.23	6	50	361	15.1	137,00€
	BZMJ-0.23-7.5-3	0.23	7.5	50	451	18.8	152,00€
	BZMJ-0.23-10-3	0.23	10	50	602	25.1	190,00€
	BZMJ-0.23-12-3	0.23	12	50	722	30.1	235,00€
	BZMJ-0.23-15-3	0.23	15	50	903	37.7	262,00€
	BZMJ-0.23-20-3	0.23	20	50	1203	50.2	345,00€
	BZMJ-0.4-3-3	0.4	3	50	60	4.3	89,00€
	BZMJ-0.4-5-3	0.4	5	50	99	7.2	93,00€
	BZMJ-0.4-6-3	0.4	6	50	119	8.7	97,00€
	BZMJ-0.4-7.5-3	0.4	7.5	50	149	10.8	100,00€
	BZMJ-0.4-8-3	0.4	8	50	159	11.5	112,00€
	BZMJ-0.4-10-3	0.4	10	50	199	14.4	121,00€
	BZMJ-0.4-12-3	0.4	12	50	239	17.3	133,00€
	BZMJ-0.4-14-3	0.4	14	50	279	20.2	145,00€
	BZMJ-0.4-15-3	0.4	15	50	298	21.7	152,00€
	BZMJ-0.4-16-3	0.4	16	50	318	23.1	158,00€
	BZMJ-0.4-18-3	0.4	18	50	358	26.0	163,00€
	BZMJ-0.4-20-3	0.4	20	50	398	28.9	170,00€
	BZMJ-0.4-25-3	0.4	25	50	497	36.1	186,00€
	BZMJ-0.4-30-3	0.4	30	50	597	43.3	236,00€
	BZMJ-0.4-40-3	0.4	40	50	796	57.7	294,00€
	BZMJ-0.4-50-3	0.4	50	50	995	72.2	319,00€
	BZMJ-0.4-60-3	0.4	60	50	1194	86.6	375,00€

F4	Referencia	Tensión nominal kV	Capacidad nominal kVar	Frecuencia nominal Hz	Capacidad nominal μ F	Corriente nominal A	P.V.P.
	BZMJ-0.45-3-3	0.45	3	50	47	3.8	107,00€
	BZMJ-0.45-5-3	0.45	5	50	79	6.4	112,00€
	BZMJ-0.45-6-3	0.45	6	50	94	7.7	117,00€
	BZMJ-0.45-7.5-3	0.45	7.5	50	118	9.6	120,00€
	BZMJ-0.45-8-3	0.45	8	50	126	10.3	134,00€
	BZMJ-0.45-10-3	0.45	10	50	157	12.8	145,00€
	BZMJ-0.45-12-3	0.45	12	50	189	15.4	160,00€
	BZMJ-0.45-14-3	0.45	14	50	220	18.0	174,00€
	BZMJ-0.45-15-3	0.45	15	50	236	19.2	182,00€
	BZMJ-0.45-16-3	0.45	16	50	252	20.5	190,00€
	BZMJ-0.45-18-3	0.45	18	50	283	23.1	196,00€
	BZMJ-0.45-20-3	0.45	20	50	314	25.7	204,00€
	BZMJ-0.45-25-3	0.45	25	50	393	32.1	223,00€
	BZMJ-0.45-30-3	0.45	30	50	472	38.5	283,00€
	BZMJ-0.45-40-3	0.45	40	50	629	51.3	353,00€
	BZMJ-0.45-50-3	0.45	50	50	786	64.2	383,00€
	BZMJ-0.45-60-3	0.45	60	50	943	77.0	450,00€
	BZMJ-0.525-5-3	0.525	5	50	58	5.5	107,00€
	BZMJ-0.525-10-3	0.525	10	50	115	11.0	145,00€
	BZMJ-0.525-15-3	0.525	15	50	173	16.5	182,00€
	BZMJ-0.525-20-3	0.525	20	50	231	22.0	204,00€
	BZMJ-0.525-25-3	0.525	25	50	289	27.5	223,00€
	BZMJ-0.525-30-3	0.525	30	50	346	33.0	283,00€
	BZMJ-0.525-40-3	0.525	40	50	462	44.0	353,00€
	BZMJ-0.525-50-3	0.525	50	50	577	55.0	383,00€
	BZMJ-0.525-60-3	0.525	60	50	693	66.0	450,00€
	BZMJ-0.69-5-3	0.69	5	50	33	4.2	118,00€
	BZMJ-0.69-10-3	0.69	10	50	67	8.4	151,00€
	BZMJ-0.69-15-3	0.69	15	50	100	12.6	193,00€
	BZMJ-0.69-20-3	0.69	20	50	134	16.7	206,00€
	BZMJ-0.69-25-3	0.69	25	50	167	20.9	228,00€
	BZMJ-0.69-30-3	0.69	30	50	201	25.1	292,00€
	BZMJ-0.69-40-3	0.69	40	50	267	33.5	368,00€
	BZMJ-0.69-50-3	0.69	50	50	334	41.8	396,00€
	BZMJ-0.69-60-3	0.69	60	50	401	50.2	471,00€
	BZMJ 1.14-10-3	1.14	10	50	25	5.1	175,00€
	BZMJ 1.14-15-3	1.14	15	50	37	7.6	218,00€
	BZMJ-0.4-7.5-3YN(*)	0.4	7.5	50	149	10.8	100,00€
	BZMJ-0.4-10-3YN(*)	0.4	10	50	199	14.4	121,00€
	BZMJ-0.4-15-3YN(*)	0.4	15	50	298	21.7	152,00€
	BZMJ-0.4-20-3YN(*)	0.4	20	50	398	28.9	170,00€

Nota: Los modelos marcados (*) se utilizan para compensación de fases individualmente, el mayor de los cuatro terminales debe conectarse al neutro

NWC5

Condensadores de C.A. - paralelos autorregenerados

F4	Referencia	Tensión nominal kV	Capacidad nominal kVar	Frecuencia nominal Hz	Capacidad nominal μ F	Corriente nominal A	P.V.P.
	NWC5-0.4-10-3	0.4	10	50	199	14.4	75,00€
	NWC5-0.4-12-3	0.4	12	50	239	17.3	88,00€
	NWC5-0.4-14-3	0.4	14	50	279	20.2	99,00€
	NWC5-0.4-15-3	0.4	15	50	298	21.7	103,00€
	NWC5-0.4-16-3	0.4	16	50	318	23.1	109,00€
	NWC5-0.4-18-3	0.4	18	50	358	26.0	114,00€
	NWC5-0.4-20-3	0.4	20	50	398	28.9	120,00€
	NWC5-0.4-25-3	0.4	25	50	497	36.1	133,00€
	NWC5-0.45-10-3	0.45	10	50	157	12.8	78,00€
	NWC5-0.45-12-3	0.45	12	50	189	15.4	98,00€
	NWC5-0.45-14-3	0.45	14	50	220	18.0	107,00€
	NWC5-0.45-15-3	0.45	15	50	236	19.2	115,00€
	NWC5-0.45-16-3	0.45	16	50	252	20.	121,00€
	NWC5-0.45-18-3	0.45	18	50	283	23.1	125,00€
	NWC5-0.45-20-3	0.45	20	50	314	25.7	131,00€
	NWC5-0.45-25-3	0.45	25	50	393	32.1	144,00€
	NWC5-0.525-10-3	0.525	10	50	115	11.0	80,00€
	NWC5-0.525-12-3	0.525	12	50	139	13.2	100,00€
	NWC5-0.525-14-3	0.525	14	50	162	15.4	110,00€
	NWC5-0.525-15-3	0.525	15	50	173	16.5	119,00€
	NWC5-0.525-16-3	0.525	16	50	185	17.6	125,00€
	NWC5-0.525-18-3	0.525	18	50	208	19.8	131,00€
	NWC5-0.525-20-3	0.525	20	50	231	22.0	148,00€
	NWC5-0.525-25-3	0.525	25	50	289	27.55	159,00€



Condensadores autorregenerables

Los condensadores de papel tienen aplicaciones en ambientes industriales. Los condensadores autorregenerables son condensadores de papel, pero la armadura se realiza depositando aluminio sobre el papel. Ante una situación de sobrecarga que supere la rigidez dieléctrica del dieléctrico, el papel se rompe en algún punto, produciéndose un cortocircuito entre las armaduras, pero el propio cortocircuito provoca una alta densidad de corriente por la armadura en la zona de la rotura. Esta corriente funde la fina capa de aluminio que rodea el punto del cortocircuito, restableciendo el aislamiento entre las armaduras.



JBK5 Transformadores de tensión

F3	Referencia	Potencia (VA)	Tensión Primario (V)	Tensión Secundario (V)	P.V.P.
UNA TENSION DE PRIMARIO (1P) Y UNA TENSION DE SECUNDARIO (1S)					
	JBK5-40-(1P)/(1S)	40	230, 400	6, 12, 24, 36, 110, 127, 230, 400	23,00€
	JBK5-63-(1P)/(1S)	63			25,00€
	JBK5-100-(1P)/(1S)	100			37,10€
	JBK5-160-(1P)/(1S)	160			48,40€
	JBK5-250-(1P)/(1S)	250			64,00€
	JBK5-400-(1P)/(1S)	400			84,50€
	JBK5-630-(1P)/(1S)	630			91,40€
	JBK5-1000-(1P)/(1S)	1000			107,80€
	JBK5-1600-(1P)/(1S)	1600			114,90€
	JBK5-2500-(1P)/(1S)	2500			123,90€
UNA TENSION DE PRIMARIO (1P) Y DOS TENSIONES DE SECUNDARIO (2S)					
	JBK5-40-(1P)/(2S)	40	230, 400	6, 12, 24, 36, 110, 127, 230, 400	27,00€
	JBK5-63-(1P)/(2S)	63			29,00€
	JBK5-100-(1P)/(2S)	100			41,10€
	JBK5-160-(1P)/(2S)	160			52,20€
	JBK5-250-(1P)/(2S)	250			68,00€
	JBK5-400-(1P)/(2S)	400			88,50€
	JBK5-630-(1P)/(2S)	630			95,40€
	JBK5-1000-(1P)/(2S)	1000			111,80€
	JBK5-1600-(1P)/(2S)	1600			118,90€
	JBK5-2500-(1P)/(2S)	2500			127,90€
DOS TENSIONES DE PRIMARIO (2P) Y UNA TENSION DE SECUNDARIO (1S)					
	JBK5-40-(2P)/(1S)	40	230, 400	6, 12, 24, 36, 110, 127, 230, 400	27,00€
	JBK5-63-(2P)/(1S)	63			29,00€
	JBK5-100-(2P)/(1S)	100			41,10€
	JBK5-160-(2P)/(1S)	160			52,20€
	JBK5-250-(2P)/(1S)	250			68,00€
	JBK5-400-(2P)/(1S)	400			88,50€
	JBK5-630-(2P)/(1S)	630			95,40€
	JBK5-1000-21P)/(1S)	1000			111,80€
	JBK5-1600-(2P)/(1S)	1600			118,90€
	JBK5-2500-(2P)/(1S)	2500			127,90€
DOS TENSIONES DE PRIMARIO (2P) Y DOS TENSIONES DE SECUNDARIO (2S)					
	JBK5-40-(2P)/(2S)	40	230, 400	6, 12, 24, 36, 110, 127, 230, 400	32,00€
	JBK5-63-(2P)/(2S)	63			34,00€
	JBK5-100-(2P)/(2S)	100			46,10€
	JBK5-160-(2P)/(2S)	160			57,20€
	JBK5-250-(2P)/(2S)	250			73,00€
	JBK5-400-(2P)/(2S)	400			93,50€
	JBK5-630-(2P)/(2S)	630			100,40€
	JBK5-1000-(2P)/(2S)	1000			116,80€
	JBK5-1600-(2P)/(2S)	1600			123,90€
	JBK5-2500-(2P)/(2S)	2500			132,90€

Nota: Sustituir (1P,2P) por la/s tensión/es del primario. Sustituir (1S,2S) por las tensión/es del secundario
 Nota: Bajo demanda pueden suministrarse tensiones distintas a las estándar





BH-0.66
Transformadores de corriente

BH-0.66-I
Transformadores de corriente



BH-0.66





BH-0.66-20I





BH-0.66-30I
clase 0.2

F5	Referencia	Relación de transformación (I _p n/I _s n)	Salida nominal (VA)				Vueltas de cable	
			Clase de precisión					
			1	0.5	0.5S	0.2		
	BH-0.66/5/0.5	5/5	5	2.5				12,90€
	BH-0.66/10/0.5	10/5	5	2.5				12,90€
	BH-0.66/15/0.5	15/5	5	2.5				12,90€
	BH-0.66/20/0.5	20/5	5	2.5				12,90€
	BH-0.66/25/0.5	25/5	5	2.5				12,90€
	BH-0.66/30/0.5	30/5	5	2.5				12,90€
	BH-0.66/40/0.5	40/5	5	2.5				12,90€
	BH-0.66/50/0.5	50/5	5	2.5				12,90€
	BH-0.66/75/0.5	75/5	5	2.5				12,90€
	BH-0.66-20I/75/1	75/5	2.5				1	13,10€
	BH-0.66-20I/100/1	100/5	2.5				1	13,10€
	BH-0.66-30I/30/0.5	30/5	2.5	5			5	14,05€
	BH-0.66-30I/50/0.5	50/5	2.5	5			3	14,05€
	BH-0.66-30I/75/0.5	75/5		2.5			1	14,05€
	BH-0.66-30I/100/0.5	100/5		2.5			1	14,05€
	BH-0.66-30I/150/0.5	150/5	2.5	5			1	14,05€
	BH-0.66-30I/200/0.5	200/5	5	5			1	14,05€
	BH-0.66-30I/250/0.5	250/5	5	5			1	14,05€
	BH-0.66-30I/300/0.5	300/5	5	5			1	14,05€
	BH-0.66-30I/400/0.5	400/5	5	5			1	14,05€
	BH-0.66-30I/30/0.2	30/5				2.5	5	16,90€
	BH-0.66-30I/50/0.2	50/5				2.5	3	16,90€
	BH-0.66-30I/75/0.2	75/5	2.5	5			1	16,90€
	BH-0.66-30I/100/0.2	100/5	2.5	5			1	16,90€
	BH-0.66-30I/150/0.2	150/5				2.5	1	16,90€
	BH-0.66-30I/200/0.2	200/5				5	1	16,90€
	BH-0.66-30I/250/0.2	250/5				5	1	16,90€
	BH-0.66-30I/300/0.2	300/5				5	1	16,90€

Nota: La clase de precisión estandar es 0.5, excepto en los casos en los que ésta no esté disponible.
Otras clases de precisión: bajo demanda.

F5	Referencia	Relación de transformación (I _{pn} /I _{sn})	Salida nominal (VA)				Vueltas de cable	P.V.P.
			Clase de precisión					
			1	0.5	0.5S	0.2		
	BH-0.66-40I/30/0.5	30/5	2.5	5			5	16,10€
	BH-0.66-40I/50/0.5	50/5	2.5	5			3	16,10€
	BH-0.66-40I/75/0.5	75/5		2.5			1	16,10€
	BH-0.66-40I/100/0.5	100/5		2.5			1	16,10€
	BH-0.66-40I/150/0.5	150/5	2.5	5			1	16,10€
	BH-0.66-40I/200/0.5	200/5	5	5			1	16,10€
	BH-0.66-40I/250/0.5	250/5	5	5			1	16,10€
	BH-0.66-40I/300/0.5	300/5	5	5			1	16,10€
	BH-0.66-40I/400/0.5	400/5	5	5			1	16,10€
	BH-0.66-40I/500/0.5	500/5	10	10			1	16,10€
	BH-0.66-40I/600/0.5	600/5	10	10			1	16,10€
	BH-0.66-40I/750/0.5	750/5	10	10		5	1	16,10€
	BH-0.66-40I/800/0.5	800/5	10	10		5	1	16,10€
	BH-0.66-50I/150/0.5	150/5		2.5		10	1	28,90€
	BH-0.66-50I/200/0.5	200/5	2.5	5		10	1	28,90€
	BH-0.66-50I/250/0.5	250/5	5	5			1	28,90€
	BH-0.66-50I/300/0.5	300/5	5	5			1	28,90€
	BH-0.66-50I/400/0.5	400/5	5	5			1	28,90€
	BH-0.66-50I/500/0.5	500/5	10	10	5	5	1	28,90€
	BH-0.66-50I/600/0.5	600/5	10	10	5	5	1	30,50€
	BH-0.66-50I/750/0.5	750/5	10	10	10	10	1	30,50€
	BH-0.66-50I/800/0.5	800/5	10	10	10	10	1	30,50€
	BH-0.66-50I/1000/0.5	1000/5	10	10	10	10	1	31,40€
	BH-0.66-50I/1200/0.5	1200/5	20	20	20	20	1	31,40€
	BH-0.66-50I/1500/0.5	1500/5	20	20	20	20	1	31,40€
	BH-0.66-60I/200/0.5	200/5		5			1	28,90€
	BH-0.66-60I/250/0.5	250/5	5	5			1	28,90€
	BH-0.66-60I/300/0.5	300/5	5	5			1	28,90€
	BH-0.66-60I/400/0.5	400/5	5	5			1	28,90€
	BH-0.66-60I/500/0.5	500/5	10	10	5	5	1	28,90€
	BH-0.66-60I/600/0.5	600/5	10	10	5	5	1	30,60€
	BH-0.66-60I/750/0.5	750/5	10	10	10	10	1	30,60€
	BH-0.66-60I/800/0.5	800/5	10	10	10	10	1	30,60€
BH-0.66-60I	BH-0.66-60I/1000/0.5	1000/5	10	10	10	10	1	32,00€
	BH-0.66-60I/1200/0.5	1200/5	20	20	20	20	1	33,20€
	BH-0.66-60I/1500/0.5	1500/5	20	20	20	20	1	36,10€
	BH-0.66-60I/2000/0.5	2000/5	20	20	20	20	1	43,50€





Nota: La clase de precisión estándar es 0.5 excepto en los casos en los que ésta no esté disponible.
Otras clases de precisión: bajo demanda.

F5	Referencia	Relación de transformación (I _{pn} /I _{sn})	Salida nominal (VA)				Vueltas de cable	P.V.P.
			Clase de precisión					
			1	0.5	0.5S	0.2		
 BH-0.66-80I	BH-0.66-80I/300/0.5	300/5	5	5			1	30,20€
	BH-0.66-80I/400/0.5	400/5	5	5			1	30,20€
	BH-0.66-80I/500/0.5	500/5	10	10			1	30,20€
	BH-0.66-80I/600/0.5	600/5	10	10			1	30,20€
	BH-0.66-80I/750/0.5	750/5	10	10	10	10	1	30,20€
	BH-0.66-80I/800/0.5	800/5	10	10	10	10	1	30,20€
	BH-0.66-80I/1000/0.5	1000/5	10	10	10	10	1	32,00€
 BH-0.66-100I	BH-0.66-80I/1200/0.5	1200/5	20	20	20	20	1	35,30€
	BH-0.66-80I/1500/0.5	1500/5	20	20	20	20	1	37,40€
	BH-0.66-80I/2000/0.5	2000/5	20	20	20	20	1	39,70€
	BH-0.66-80I/2500/0.5	2500/5	40	40	40	40	1	45,90€
	BH-0.66-100I/600/0.5	600/5	10	10			1	35,70€
	BH-0.66-100I/750/0.5	750/5	10	10	10	10	1	35,70€
	BH-0.66-100I/800/0.5	800/5	10	10	10	10	1	35,70€
 BH-0.66-120I	BH-0.66-100I/1000/0.5	1000/5	10	10	10	10	1	40,00€
	BH-0.66-100I/1200/0.5	1200/5	20	20	20	20	1	40,00€
	BH-0.66-100I/1500/0.5	1500/5	20	20	20	20	1	40,00€
	BH-0.66-100I/2000/0.5	2000/5	20	20	20	20	1	49,10€
	BH-0.66-100I/2500/0.5	2500/5	40	40	40	40	1	58,60€
	BH-0.66-100I/3000/0.5	3000/5	40	40	40	40	1	63,40€
	BH-0.66-120I/1000/0.5	1000/5	10	10	10	10	1	48,60€
	BH-0.66-120I/1200/0.5	1200/5	20	20	20	20	1	48,60€
	BH-0.66-120I/1500/0.5	1500/5	20	20	20	20	1	48,60€
	BH-0.66-120I/2000/0.5	2000/5	20	20	20	20	1	56,20€
	BH-0.66-120I/2500/0.5	2500/5	40	40	40	40	1	68,70€
	BH-0.66-120I/3000/0.5	3000/5	40	40	40	40	1	79,50€
	BH-0.66-120I/4000/0.5	4000/5	40	40	40	40	1	88,90€
	BH-0.66-120I/5000/0.5	5000/5	40	40	40	40	1	99,90€



Nota: La clase de precisión estandar es 0.5, excepto en los casos en los que ésta no esté disponible.
Otras clases de precisión: bajo demanda

BH-0.66-II

Transformadores de corriente

F5	Referencia	Relación de transformación (I _{pn} /I _{sn})	Salida nominal (VA)				Vueltas de cable	P.V.P.
			Clase de precisión					
			1	0.5	0.5S	0.2		
	BH-0.66-40II/150/0.5	150/5	5	2.5			1	18,30€
	BH-0.66-40II/200/0.5	200/5	5	5			1	18,30€
	BH-0.66-40II/250/0.5	250/5	5	5			1	18,30€
	BH-0.66-40II/300/0.5	300/5	5	5			1	18,30€
	BH-0.66-40II/400/0.5	400/5	5	5			1	18,30€
	BH-0.66-40II/500/0.5	500/5	10	10	5	5	1	18,30€
	BH-0.66-40II/600/0.5	600/5	10	10	5	5	1	18,30€
	BH-0.66-40II/750/0.5	750/5	10	10	10	10	1	18,30€
	BH-0.66-40II/800/0.5	800/5	10	10	10	10	1	18,30€
	BH-0.66-50II/150/0.5	150/5	2.5	2.5			1	30,00€
	BH-0.66-50II/200/0.5	200/5	5	5			1	30,00€
	BH-0.66-50II/250/0.5	250/5	5	5			1	30,00€
	BH-0.66-50II/300/0.5	300/5	5	5			1	30,00€
	BH-0.66-50II/400/0.5	400/5	5	5			1	30,00€
	BH-0.66-50II/500/0.5	500/5	10	10	5	5	1	32,20€
	BH-0.66-50II/600/0.5	600/5	10	10	5	5	1	32,20€
	BH-0.66-50II/750/0.5	750/5	10	10	10	10	1	32,20€
	BH-0.66-50II/800/0.5	800/5	10	10	10	10	1	32,20€
	BH-0.66-50II/1000/0.5	1000/5	10	10	10	10	1	33,40€
	BH-0.66-50II/1200/0.5	1200/5	20	20	20	20	1	33,40€
	BH-0.66-50II/1500/0.5	1500/5	20	20	20	20	1	33,40€
	BH-0.66-60II/300/0.5	300/5	5	5			1	34,60€
	BH-0.66-60II/400/0.5	400/5	5	5			1	34,60€
	BH-0.66-60II/500/0.5	500/5	10	10	5	5	1	34,60€
	BH-0.66-60II/600/0.5	600/5	10	10	5	5	1	35,90€
	BH-0.66-60II/750/0.5	750/5	10	10	10	10	1	35,90€
	BH-0.66-60II/800/0.5	800/5	10	10	10	10	1	36,10€
	BH-0.66-60II/1000/0.5	1000/5	10	10	10	10	1	37,20€
	BH-0.66-60II/1200/0.5	1200/5	20	20	20	20	1	38,00€
	BH-0.66-60II/1500/0.5	1500/5	20	20	20	20	1	38,00€
	BH-0.66-60II/2000/0.5	2000/5	20	20	20	20	1	38,00€
	BH-0.66-80II/600/0.5	600/5	10	10			1	34,10€
	BH-0.66-80II/750/0.5	750/5	10	10			1	34,10€
	BH-0.66-80II/800/0.5	800/5	10	10	10	10	1	34,10€
	BH-0.66-80II/1000/0.5	1000/5	10	10	10	10	1	38,60€
	BH-0.66-80II/1200/0.5	1200/5	20	20	20	20	1	38,60€
	BH-0.66-80II/1500/0.5	1500/5	20	20	20	20	1	43,10€
	BH-0.66-80II/2000/0.5	2000/5	20	20	20	20	1	46,40€
	BH-0.66-80II/2500/0.5	2500/5	40	40	40	40	1	52,30€



Nota: La clase de precisión estándar es 0.5, excepto en los casos en los que ésta no esté disponible.
Otras clases de precisión: bajo demanda







F5	Referencia	Relación de transformación (I _p /I _{sn})	Salida nominal (VA)				Vueltas de cable	P.V.P.
			Clase de precisión					
			1	0.5	0.5S	0.2		
	BH-0.66-100II/1000/0.5	1000/5	10	10	10	10	1	43,90€
	BH-0.66-100II/1200/0.5	1200/5	20	20	20	20	1	43,90€
	BH-0.66-100II/1500/0.5	1500/5	20	20	20	20	1	43,90€
	BH-0.66-100II/2000/0.5	2000/5	20	20	20	20	1	53,70€
	BH-0.66-100II/2500/0.5	2500/5	40	40	40	40	1	68,20€
	BH-0.66-100II/3000/0.5	3000/5	40	40	40	40	1	65,70€
	BH-0.66-100II/4000/0.5	4000/5	40	40	40	40	1	79,70€
	BH-0.66-120II/1000/0.5	1000/5	10	10	10	10	1	53,20€
	BH-0.66-120II/1200/0.5	1200/5	20	20	20	20	1	53,20€
	BH-0.66-120II/1500/0.5	1500/5	20	20	20	20	1	53,20€
	BH-0.66-120II/2000/0.5	2000/5	20	20	20	20	1	64,80€
	BH-0.66-120II/2500/0.5	2500/5	40	40	40	40	1	74,10€
	BH-0.66-120II/3000/0.5	3000/5	40	40	40	40	1	83,50€
	BH-0.66-120II/4000/0.5	4000/5	40	40	40	40	1	96,50€
	BH-0.66-120II/5000/0.5	5000/5	40	40	40	40	1	110,30€

Nota: La clase de precisión estandar es 0.5, excepto en los casos en los que ésta no esté disponible.
Otras clases de precisión: bajo demanda

BH-0.66-III

Transformadores de corriente

F5	Referencia	Relación de transformación (I _p /I _{sn})	Salida nominal (VA)				Vueltas de cable	P.V.P.
			Clase de precisión					
			1	0.5	0.5S	0.2		
	BH-0.66-20III/75/1	75/5	5				1	13,10€
	BH-0.66-20III/100/1	100/5	5				1	13,10€
	BH-0.66-20III/150/0.5	150/5	10	5			1	13,10€
	BH-0.66-20III/200/0.5	200/5	10	5			1	13,10€
	BH-0.66-30III/150/0.5	150/5	10	5	5	5	1	14,05€
	BH-0.66-30III/200/0.5	200/5	10	5	5	5	1	14,05€
	BH-0.66-30III/250/0.5	250/5	10	5	5	5	1	14,05€
	BH-0.66-30III/300/0.5	300/5	10	10	5	5	1	14,05€
	BH-0.66-30III/400/0.5	400/5	10	10	5	5	1	14,05€
	BH-0.66-30III/500/0.5	500/5	10	10	10	10	1	14,05€
	BH-0.66-30III/600/0.5	600/5	10	10	10	10	1	14,05€
	BH-0.66-40III/150/0.5	150/5	10	5			1	16,10€
	BH-0.66-40III/200/0.5	200/5	10	5	5	5	1	16,10€
	BH-0.66-40III/250/0.5	250/5	10	5	5	5	1	16,10€
	BH-0.66-40III/300/0.5	300/5	10	10	10	10	1	16,10€
	BH-0.66-40III/400/0.5	400/5	10	10	10	10	1	16,10€
	BH-0.66-40III/500/0.5	500/5	10	10	10	10	1	16,10€
	BH-0.66-40III/600/0.5	600/5	10	10	10	10	1	16,10€
	BH-0.66-40III/750/0.5	750/5	10	10	10	10	1	16,10€
	BH-0.66-40III/800/0.5	800/5	10	10	20	20	1	16,10€
	BH-0.66-40III/1000/0.5	1000/5	10	10	20	20	1	16,10€
	BH-0.66-40III/1200/0.5	1200/5	20	20			1	16,10€
	BH-0.66-40III/1500/0.5	1500/5	20	20			1	16,10€

F5	Referencia	Relación de transformación (I _{pn} /I _{sn})	Salida nominal (VA)				Vueltas de cable	P.V.P.
			Clase de precisión					
			1	0.5	0.5S	0.2		
	BH-0.66-50III/300/0.5	300/5	10	10	10	10	1	28,90€
	BH-0.66-50III/400/0.5	400/5	10	10	10	10	1	28,90€
	BH-0.66-50III/500/0.5	500/5	10	10	10	10	1	28,90€
	BH-0.66-50III/600/0.5	600/5	10	10	10	10	1	30,50€
	BH-0.66-50III/750/0.5	750/5	10	10	10	10	1	30,50€
	BH-0.66-50III/800/0.5	800/5	10	10	20	20	1	30,50€
	BH-0.66-50III/1000/0.5	1000/5	10	10	20	20	1	31,40€
	BH-0.66-50III/1200/0.5	1200/5	20	20	10	10	1	31,40€
	BH-0.66-50III/1500/0.5	1500/5	20	20	10	10	1	31,40€
	BH-0.66-60III/500/0.5	500/5	10	10	10	10	1	34,60€
	BH-0.66-60III/600/0.5	600/5	10	10	10	10	1	34,60€
	BH-0.66-60III/750/0.5	750/5	10	10	10	10	1	35,90€
	BH-0.66-60III/800/0.5	800/5	10	10	20	20	1	36,10€
	BH-0.66-60III/1000/0.5	1000/5	10	10	20	20	1	37,20€
	BH-0.66-60III/1200/0.5	1200/5	20	20	40	40	1	38,00€
	BH-0.66-60III/1500/0.5	1500/5	20	20	10	10	1	38,00€
	BH-0.66-60III/2000/0.5	2000/5	40	40	10	10	1	38,00€
	BH-0.66-80III/500/0.5	500/5	10	10	10	10	1	34,10€
	BH-0.66-80III/600/0.5	600/5	10	10	10	10	1	34,10€
	BH-0.66-80III/750/0.5	750/5	10	10	10	10	1	34,10€
	BH-0.66-80III/800/0.5	800/5	10	10	20	20	1	34,10€
	BH-0.66-80III/1000/0.5	1000/5	10	10	20	20	1	38,60€
	BH-0.66-80III/1200/0.5	1200/5	20	20	40	40	1	38,60€
	BH-0.66-80III/1500/0.5	1500/5	20	20	40	40	1	43,10€
	BH-0.66-80III/2000/0.5	2000/5	40	40	40	40	1	46,40€
	BH-0.66-80III/2500/0.5	2500/5	40	40			1	52,30€
	BH-0.66-80III/3000/0.5	3000/5	40	40			1	60,40€
	BH-0.66-100III/800/0.5	800/5	10	10	10	10	1	35,70€
	BH-0.66-100III/1000/0.5	1000/5	10	10	10	10	1	40,00€
	BH-0.66-100III/1200/0.5	1200/5	20	20	20	20	1	40,00€
	BH-0.66-100III/1500/0.5	1500/5	20	20	20	20	1	40,00€
	BH-0.66-100III/2000/0.5	2000/5	40	40	40	40	1	49,10€
	BH-0.66-100III/2500/0.5	2500/5	40	40	40	40	1	58,60€
	BH-0.66-100III/3000/0.5	3000/5	40	40	40	40	1	63,40€
	BH-0.66-100III/4000/0.5	4000/5	40	40	40	40	1	85,10€
	BH-0.66-120III/1000/0.5	1000/5	10	10	10	10	1	48,60€
	BH-0.66-120III/1200/0.5	1200/5	20	20	20	20	1	48,60€
	BH-0.66-120III/1500/0.5	1500/5	20	20	20	20	1	48,60€
	BH-0.66-120III/2000/0.5	2000/5	40	40	40	40	1	56,20€
	BH-0.66-120III/2500/0.5	2500/5	40	40	40	40	1	68,70€
	BH-0.66-120III/3000/0.5	3000/5	40	40	40	40	1	79,50€
	BH-0.66-120III/4000/0.5	4000/5	40	40	40	40	1	88,90€
BH-0.66-120III/5000/0.5	5000/5	40	40	40	40	1	99,90€	

Nota: La clase de precisión estándar es 0.5, excepto en los casos en los que ésta no esté disponible.
Otras clases de precisión: bajo demanda



NH Seccionadores y conmutadores

NH40

Seccionadores manuales - mando directo
16 a 1000A Corte en carga- 1250 a 3150A Corte en vacío

F2	Referencia (Mando directo)	Calibre de fusibles asociados (A)	Corriente 400Vca AC22	Corriente 690Vca AC21	Corriente 230Vcc DC22	Corriente 440Vcc DC21	P.V.P.
	NH40-16/3	16	16	16	16	16	35,00€
	NH40-32/3	32	32	32	32	32	43,80€
	NH40-40/3	40	40	40	40	40	45,60€
	NH40-63/3	63	63	63	63	63	55,50€
	NH40-80/3	80	80	80	80	80	62,10€
	NH40-100/3	100	100	100	100	100	69,70€
	NH40-125/3	125	125	125	125	125	77,70€
	NH40-160/3	160	160	160	160	160	81,30€
	NH40-200/3	200	200	160	200	160	124,30€
	NH40-250/3	250	250	200	250	200	153,70€
	NH40-315/3	315	315	315	315	315	173,70€
	NH40-400/3	400	400	315	400	315	212,70€
	NH40-630/3	630	630	500	630	500	270,60€
	NH40-1000/3	1000	1000	800	1000	800	807,40€
	NH40-1250/3	1250	1250	800	1250	800	886,40€
	NH40-1600/3	2x800	1600	1000	1600	1000	965,20€
	NH40-2000/3	2x1000	2000	1600	2000	1600	2.330,50€
	NH40-2500/3	2x1250	2500	1600	2500	1600	2.544,20€
	NH40-3150/3	-	3150	2000	3150	2000	2.713,70€
	NH40-16/4	16	16	16	16	16	45,00€
	NH40-32/4	32	32	32	32	32	53,40€
	NH40-40/4	40	40	40	40	40	60,10€
	NH40-63/4	63	63	63	63	63	65,40€
	NH40-80/4	80	80	80	80	80	69,80€
	NH40-100/4	100	100	100	100	100	76,40€
	NH40-125/4	125	125	125	125	125	84,40€
	NH40-160/4	160	160	160	160	160	90,70€
	NH40-200/4	200	200	200	200	200	144,30€
	NH40-250/4	250	250	250	250	250	174,80€
	NH40-315/4	315	315	315	315	315	205,30€
	NH40-400/4	400	400	315	400	315	246,40€
	NH40-630/4	630	630	500	630	500	308,50€
	NH40-1000/4	1000	1000	800	1000	800	702,20€
	NH40-1250/4	1250	1250	800	1250	800	1.059,00€
	NH40-1600/4	2x800	1600	1000	1600	1000	1.196,80€
	NH40-2000/4	2x1000	2000	1600	2000	1600	2.541,00€
	NH40-2500/4	2x1250	2500	1600	2500	1600	2.734,70€
	NH40-3150/4	-	3150	2000	3150	2000	2.962,10€



NH40-(*)/(*)/(*)

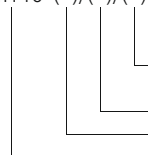

Composición de la referencia
para pedidos

- C: Palanca a la derecha del aparato (bajo demanda)
Sin letra: palanca central
- Polos: (3, 4)
- Corriente nominal (Ith)
- Serie

NH40-W

Seccionadores manuales - mando por eje prolongado
16 a 1000A Corte en carga- 1250 a 3150A Corte en vacío

F2	Referencia (Mando directo)	Calibre de fusibles asociados (A)	Corriente 400Vca AC22	Corriente 690Vca AC21	Corriente 230Vcc DC22	Corriente 440Vcc DC21	P.V.P.
	NH40-16/3W	16	16	16	16	16	40,10€
	NH40-32/3W	32	32	32	32	32	48,40€
	NH40-40/3W	40	40	40	40	40	53,10€
	NH40-63/3W	63	63	63	63	63	61,70€
	NH40-80/3W	80	80	80	80	80	66,20€
	NH40-100/3W	100	100	100	100	100	71,90€
	NH40-125/3W	125	125	125	125	125	81,00€
	NH40-160/3W	160	160	160	160	160	87,60€
	NH40-200/3W	200	200	160	200	160	130,60€
	NH40-250/3W	250	250	200	250	200	159,00€
	NH40-315/3W	315	315	315	315	315	180,10€
	NH40-400/3W	400	400	315	400	315	225,30€
	NH40-630/3W	630	630	500	630	500	281,10€
	NH40-1000/3W	1000	1000	800	1000	800	817,90€
	NH40-1250/3W	1250	1250	800	1250	800	896,80€
	NH40-1600/3W	2x800	1600	1000	1600	1000	967,30€
	NH40-2000/3W	2x1000	2000	1600	2000	1600	-
	NH40-2500/3W	2x1250	2500	1600	2500	1600	-
	NH40-3150/3W	-	3150	2000	3150	2000	-
	NH40-16/4W	16	16	16	16	16	50,10€
	NH40-32/4W	32	32	32	32	32	58,80€
	NH40-40/4W	40	40	40	40	40	63,40€
	NH40-63/4W	63	63	63	63	63	68,60€
	NH40-80/4W	80	80	80	80	80	75,00€
	NH40-100/4W	100	100	100	100	100	80,00€
	NH40-125/4W	125	125	125	125	125	95,00€
	NH40-160/4W	160	160	160	160	160	101,30€
	NH40-200/4W	200	200	200	200	200	154,80€
	NH40-250/4W	250	250	250	250	250	185,30€
	NH40-315/4W	315	315	315	315	315	215,80€
	NH40-400/4W	400	400	315	400	315	256,90€
	NH40-630/4W	630	630	500	630	500	319,00€
	NH40-1000/4W	1000	1000	800	1000	800	712,70€
	NH40-1250/4W	1250	1250	800	1250	800	1.071,60€
	NH40-1600/4W	2x800	1600	1000	1600	1000	1.204,30€
	NH40-2000/4W	2x1000	2000	1600	2000	1600	-
	NH40-2500/4W	2x1250	2500	1600	2500	1600	-
	NH40-3150/4W	-	3150	2000	3150	2000	-



NH40-S

Conmutadores manuales - mando directo

16 a 1000A Corte en carga- 1250 a 3150A Corte en vacío

F2	Referencia (Mando directo)	Calibre de fusibles asociados (A)	Corriente 400Vca AC22	Corriente 690Vca AC21	Corriente 230Vcc DC22	Corriente 440Vcc DC21	P.V.P.
	NH40-16/3S	16	16	16	16	16	81,20€
	NH40-32/3S	32	32	32	32	32	97,70€
	NH40-40/3S	40	40	40	40	40	102,40€
	NH40-63/3S	63	63	63	63	63	124,00€
	NH40-80/3S	80	80	80	80	80	137,30€
	NH40-100/3S	100	100	100	100	100	155,10€
	NH40-125/3S	125	125	125	125	125	173,80€
	NH40-160/3S	160	160	160	160	160	182,40€
	NH40-200/3S	200	200	160	200	160	275,00€
	NH40-250/3S	250	250	200	250	200	333,40€
	NH40-315/3S	315	315	315	315	315	384,20€
	NH40-400/3S	400	400	315	400	315	471,80€
	NH40-630/3S	630	630	500	630	500	590,90€
	NH40-1000/3S	1000	1000	800	1000	800	1.793,00€
	NH40-1250/3S	1250	1250	800	1250	800	1.968,80€
	NH40-1600/3S	2x800	1600	1000	1600	1000	2.144,10€
	NH40-2000/3S	2x1000	2000	1600	2000	1600	5.176,40€
	NH40-2500/3S	2x1250	2500	1600	2500	1600	5.659,60€
	NH40-3150/3S	-	3150	2000	3150	2000	6.031,00€
	NH40-16/4S	16	16	16	16	16	90,50€
	NH40-32/4S	32	32	32	32	32	117,30€
	NH40-40/4S	40	40	40	40	40	133,20€
	NH40-63/4S	63	63	63	63	63	144,40€
	NH40-80/4S	80	80	80	80	80	155,00€
	NH40-100/4S	100	100	100	100	100	168,50€
	NH40-125/4S	125	125	125	125	125	200,00€
	NH40-160/4S	160	160	160	160	160	227,90€
	NH40-200/4S	200	200	200	200	200	320,30€
	NH40-250/4S	250	250	250	250	250	388,90€
	NH40-315/4S	315	315	315	315	315	455,10€
	NH40-400/4S	400	400	315	400	315	546,30€
	NH40-630/4S	630	630	500	630	500	684,80€
	NH40-1000/4S	1000	1000	800	1000	800	1.560,70€
	NH40-1250/4S	1250	1250	800	1250	800	2.350,00€
	NH40-1600/4S	2x800	1600	1000	1600	1000	2.990,70€
	NH40-2000/4S	2x1000	2000	1600	2000	1600	5.647,30€
	NH40-2500/4S	2x1250	2500	1600	2500	1600	6.075,20€
	NH40-3150/4S	-	3150	2000	3150	2000	6.582,60€



NH40-(*)/(*)/(*)

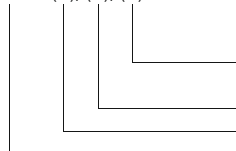

Composición de la referencia
para pedidos

C: Palanca a la derecha del aparato (bajo demanda)
Sin letra: palanca central
Polos: (3, 4)
Corriente nominal (Ith)
Serie

NH40-SW

Conmutadores manuales - mando por eje prolongado
16 a 1000A Corte en carga- 1250 a 3150A Corte en vacío

F2	Referencia (Mando directo)	Calibre de fusibles asociados (A)	Corriente 400Vca AC22	Corriente 690Vca AC21	Corriente 230Vcc DC22	Corriente 440Vcc DC21	P.V.P.
	NH40-16/3SW	16	16	16	16	16	84,90€
	NH40-32/3SW	32	32	32	32	32	99,90€
	NH40-40/3SW	40	40	40	40	40	105,30€
	NH40-63/3SW	63	63	63	63	63	127,70€
	NH40-80/3SW	80	80	80	80	80	141,20€
	NH40-100/3SW	100	100	100	100	100	159,00€
	NH40-125/3SW	125	125	125	125	125	177,50€
	NH40-160/3SW	160	160	160	160	160	186,90€
	NH40-200/3SW	200	200	160	200	160	279,70€
	NH40-250/3SW	250	250	200	250	200	338,00€
	NH40-315/3SW	315	315	315	315	315	385,40€
	NH40-400/3SW	400	400	315	400	315	475,10€
	NH40-630/3SW	630	630	500	630	500	595,70€
	NH40-1000/3SW	1000	1000	800	1000	800	1.798,30€
	NH40-1250/3SW	1250	1250	800	1250	800	1.972,00€
	NH40-1600/3SW	2x800	1600	1000	1600	1000	2.143,50€
	NH40-2000/3SW	2x1000	2000	1600	2000	1600	-
	NH40-2500/3SW	2x1250	2500	1600	2500	1600	-
	NH40-3150/3SW	-	3150	2000	3150	2000	-
	NH40-16/4SW	16	16	16	16	16	93,60€
	NH40-32/4SW	32	32	32	32	32	121,10€
	NH40-40/4SW	40	40	40	40	40	138,90€
	NH40-63/4SW	63	63	63	63	63	148,30€
	NH40-80/4SW	80	80	80	80	80	158,70€
	NH40-100/4SW	100	100	100	100	100	172,10€
	NH40-125/4SW	125	125	125	125	125	204,00€
	NH40-160/4SW	160	160	160	160	160	209,30€
	NH40-200/4SW	200	200	200	200	200	329,50€
	NH40-250/4SW	250	250	250	250	250	395,70€
	NH40-315/4SW	315	315	315	315	315	459,80€
	NH40-400/4SW	400	400	315	400	315	549,90€
	NH40-630/4SW	630	630	500	630	500	688,70€
	NH40-1000/4SW	1000	1000	800	1000	800	1.563,00€
	NH40-1250/4SW	1250	1250	800	1250	800	2.357,10€
	NH40-1600/4SW	2x800	1600	1000	1600	1000	2.997,00€
	NH40-2000/4SW	2x1000	2000	1600	2000	1600	-
	NH40-2500/4SW	2x1250	2500	1600	2500	1600	-
	NH40-3150/4SW	-	3150	2000	3150	2000	-



NH40-SZ

Conmutadores manual/automáticos
16 a 1000A Corte en Carga - 1250A, 1600A Corte en vacío

F2	Referencia (Mando directo)	Calibre de fusibles asociados (A)	Corriente 400Vca AC21	Corriente 690Vca AC20	Corriente 230Vcc DC21	Corriente 440Vcc DC20	P.V.P.
	NH40-16/3/SZ/(*)	16	16	16	16	16	102,00€
	NH40-32/3/SZ/(*)	32	32	32	32	32	121,10€
	NH40-40/3/SZ/(*)	40	40	40	40	40	127,40€
	NH40-63/3/SZ/(*)	63	63	63	63	63	155,50€
	NH40-80/3/SZ/(*)	80	80	80	80	80	175,40€
	NH40-100/3/SZ/(*)	100	100	100	100	100	193,60€
	NH40-125/3/SZ/(*)	125	125	125	125	125	216,00€
	NH40-160/3/SZ/(*)	160	160	160	160	160	227,40€
	NH40-200/3/SZ/(*)	200	200	160	200	160	343,60€
	NH40-250/3/SZ/(*)	250	250	200	250	200	416,70€
	NH40-315/3/SZ/(*)	315	315	315	315	315	480,80€
	NH40-400/3/SZ/(*)	400	400	315	400	315	588,30€
	NH40-630/3/SZ/(*)	630	630	500	630	500	737,40€
	NH40-1000/3/SZ/(*)	1000	1000	800	1000	800	2.240,60€
	NH40-1250/3/SZ/(*)	1250	1250	800	1250	800	2.462,90€
	NH40-1600/3/SZ/(*)	2x800	1600	1000	1600	1000	2.686,00€
	NH40-16/4/SZ/(*)	16	16	16	16	16	112,10€
	NH40-32/4/SZ/(*)	32	32	32	32	32	146,50€
	NH40-40/4/SZ/(*)	40	40	40	40	40	166,50€
	NH40-63/4/SZ/(*)	63	63	63	63	63	180,70€
	NH40-80/4/SZ/(*)	80	80	80	80	80	193,20€
	NH40-100/4/SZ/(*)	100	100	100	100	100	210,50€
	NH40-125/4/SZ/(*)	125	125	125	125	125	251,00€
	NH40-160/4/SZ/(*)	160	160	160	160	160	258,90€
	NH40-200/4/SZ/(*)	200	200	200	200	200	401,60€
	NH40-250/4/SZ/(*)	250	250	250	250	250	485,30€
	NH40-315/4/SZ/(*)	315	315	315	315	315	568,30€
	NH40-400/4/SZ/(*)	400	400	315	400	315	682,00€
	NH40-630/4/SZ/(*)	630	630	500	630	500	855,50€
	NH40-1000/4/SZ/(*)	1000	1000	800	1000	800	1.950,80€
	NH40-1250/4/SZ/(*)	1250	1250	800	1250	800	2.941,10€
	NH40-1600/4/SZ/(*)	2x800	1600	1000	1600	1000	3.737,40€

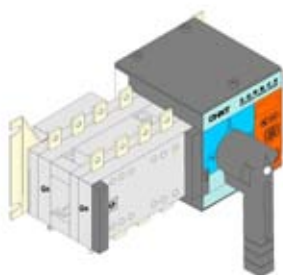

NH40-(*)/(*)/(SZ)/(*)

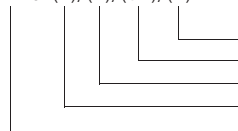

Composición de la referencia para pedidos

Tipo de fuente (ver nota al pie)
 SZ: Conmutador Manual/Automático
 Polos: (3, 4)
 Corriente nominal (Ith)
 Serie

Tipos de fuentes:

- B: Fuente normal/Fuente normal
Ninguna protección
- I: Fuente normal/Fuente normal
Con auto-conmutación y auto-reinicio
Protección contra pérdida de fase
- II: Fuente normal/Fuente normal
Con auto-conmutación y auto-reinicio.
Protección contra pérdida de fase
Protección contra sobretensión y mínima tensión
- III: Fuente normal/Generador
Con auto-conmutación y auto-reinicio.
Protección contra pérdida de fase
Protección contra sobretensión y mínima tensión

NHR40

Seccionadores manuales con fusibles - mando directo



F3	Referencia	Tamaño de los fusibles asociados	Corriente 400Vca AC21/AC22	Corriente 690Vca AC21/AC22	Corriente 230Vcc DC21/DC22	Corriente 440Vcc DC21/DC22	P.V.P.
	NHR40-160/3	T00	160	100	160	100	220,40€
	NHR40-250/3	T1	250	250	250	250	325,10€
	NHR40-400/3	T2	400	315	400	315	391,50€
	NHR40-630/3	T3	630	425	630	425	695,40€
	NHR40-160/4	T00	160	100	160	400	265,50€
	NHR40-250/4	T1	250	250	250	250	406,80€
	NHR40-400/4	T2	400	315	400	315	485,10€
	NHR40-630/4	T3	630	425	630	425	795,20€

NHR40

Seccionadores manuales con fusibles - mando por eje prolongado



F3	Referencia	Tamaño de los fusibles asociados	Corriente 400Vca AC21/AC22	Corriente 690Vca AC21/AC22	Corriente 230Vcc DC21/DC22	Corriente 440Vcc DC21/DC22	P.V.P.
	NHR40-160/3W	T00	160	100	160	100	230,40€
	NHR40-250/3W	T1	250	250	250	250	337,50€
	NHR40-400/3W	T2	400	315	400	315	405,10€
	NHR40-630/3W	T3	630	425	630	425	710,80€
	NHR40-160/4W	T00	160	100	160	400	275,50€
	NHR40-250/4W	T1	250	250	250	250	417,20€
	NHR40-400/4W	T2	400	315	400	315	496,00€
	NHR40-630/4W	T3	630	425	630	425	812,60€

NHR17

Seccionadores manuales con fusibles



F3	Referencia	Tamaño de los fusibles asociados	Corriente 400Vca AC21/AC22	Corriente 690Vca AC20	Corriente 690Vca AC21/AC22	P.V.P.
	NHR17-160/3/1	T00	160	160	100/100	140,50€
	NHR17-250/3/1	T1	250	250	200/160	212,00€
	NHR17-400/3/1	T2	400	400	315/315	259,60€
	NHR17-630/3/1	T3	630	630	425/315	363,50€

Nota: La número "1" en la referencia indica "Interruptor con microrruptor"
Eliminar este número si se desea el interruptor sin microrruptor.

NHRT40

Seccionadores manuales con fusibles



F3	Referencia	Tamaño de los fusibles asociados	Corriente 400Vca AC21/AC22	Corriente 690Vca AC20	Corriente 690Vca AC21/AC22	P.V.P.
	NHRT40-160/3/L	T00	160	160	100/100	69,40€
	NHRT40-250/3/L	T1	250	250	200/160	71,50€
	NHRT40-400/3/L	T2	400	400	315/315	85,10€
	NHRT40-630/3/L	T3	630	630	425/315	86,30€

Nota: La letra "L" en la referencia indica conexión e interrupción simultánea de las tres fases.
Eliminar esta letra si se desea el funcionamiento independiente por fases

DDS Contadores de Energía



DDS666

Contadores monofásicos electromecánicos multitarifa



F5	Referencia	Tensión	Frecuencia	Corriente nominal	P.V.P.
	DDS666-5/20	220, 230, 240Vca	50Hz, 60Hz	5(20)A	61,50€
	DDS666-5/30	220, 230, 240Vca	50Hz, 60Hz	5(30)A	62,40€
	DDS666-5/60	220, 230, 240Vca	50Hz, 60Hz	5(60)A	64,20€
	DDS666-10/40	220, 230, 240Vca	50Hz, 60Hz	10(40)A	65,00€
	DDS666-10/60	220, 230, 240Vca	50Hz, 60Hz	10(60)A	68,40€
	DDS666-15/100	220, 230, 240Vca	50Hz, 60Hz	15(100)A	75,70€
	DDS666-20/80	220, 230, 240Vca	50Hz, 60Hz	20(80)A	73,60€
	DDS666-30/100	220, 230, 240Vca	50Hz, 60Hz	30(100)A	78,90€

DDSY666

Contadores monofásicos de prepago



F5	Referencia	Tensión	Frecuencia	Corriente nominal	P.V.P.
	DDSY666-1,5/6	220, 230, 240Vca	50Hz, 60Hz	1,5(6)A	395,00€
	DDSY666-2,5/10	220, 230, 240Vca	50Hz, 60Hz	2,5(10)A	395,00€
	DDSY666-5/20	220, 230, 240Vca	50Hz, 60Hz	5(20)A	395,00€
	DDSY666-5/30	220, 230, 240Vca	50Hz, 60Hz	5(30)A	395,00€
	DDSY666-10/40	220, 230, 240Vca	50Hz, 60Hz	10(40)A	395,00€

DDSY666

Contadores monofásicos de prepago



F5	Referencia	Descripción	P.V.P.
	RW666/LC	Lector/cargador de tarjetas de prepago	530,00€
	RW666/SOFT	Software de gestión + pack de 25 tarjetas	220,00€
	RW666/CARD	Pack de 10 tarjetas	50,00€

CE

U.E



YBLX

Finales de carrera, Mirrorruptores. Pedales

YBLX

Finales de Carrera

F2	Serie	P.V.P.
	YBLX-ME8000	34,50€
	YBLX-WL	41,50€
	YBLX-HL/5000	40,60€
	YBLX-CK	40,60€
	YBLX-P1	31,10€
	YBLX-K1	20,90€
	YBLX-K2	21,80€
	YBLX-K3	22,00€
	YBLX-1	18,60€
	YBLX-2	26,40€
	YBLX-3	26,40€
	YBLX-4	89,00€
	YBLX-5	14,20€
	YBLX-6	96,40€
	YBLX-7	88,60€
	YBLX-8	76,30€
	YBLX-10	63,90€
	YBLX-12	19,30€
	YBLX-19	28,90€
	YBLX-22A	74,20€
	YBLX-29	28,10€
	YBLX-33	75,70€
	YBLX-44	41,30€
	YBLX-JW2	27,90€
	YBLX-JW2B	26,30€
	YBLX-X2	15,90€
	YBLX-11/2	35,20€



YBLXW

Microruptores

F2	Serie	P.V.P.
	YBLXW-2	16,40€
	YBLXW-3	14,30€
	YBLXW-5/11	14,20€
	YBLXW-6/11	19,90€
	YBLXW-18	21,10€
	YBLXW-028	20,60€
	YBLXW-028A	20,60€
	YBLXW-029	20,60€
	YBLXW-029A	20,60€
	YBLXW-JLXK1/11	25,40€
	YBLXW-N/A	18,60€
	YBLXW-N/B	14,90€
	YBLXW-N/C	14,90€
	YBLXW-N/D	10,50€



YBLT

Interruptores de pedal

F2	Serie	P.V.P.
	YBLT-1/11	45,10€
	YBLT-1/02	45,10€
	YBLT-2	45,10€
	YBLT-3	45,10€
	YBLT-4	45,10€
	YBLT-EKW/5A/B	45,10€
	YBLT-YDT1/11	45,10€
	YBLT-YDT1/14	45,10€
	YBLT-FS/1	45,10€
	YBLT-FS/2	45,10€
	YBLT-FS/3	45,10€
	YBLT-JDK	45,10€
	YBLT-VFS/201	45,10€



YBLX-KLT

Interruptores de tirador

F2	Serie	P.V.P.
	YBLX-KLT2/II	126,30€





JXF

CUADROS METÁLICOS CON PLACA DE MONTAJE

Tensión nominal	220...240V/380...415V
Corriente máxima	630A (trifásica)
Grado de protección	IP54 (IP65 opcional)
Temperatura	70°C - máximo admisible
Norma	UNE-EN60439-1
Chapa del cuerpo	Acero 1.2 - 1.5mm
Chapa placa montaje	Acero 2mm



1. Cierres
2. Cuerpo: Acero galvanizado
3. Espárragos tierra: Conexión de tierra entre caja y puerta
4. Orejas de fijación a pared para montaje colgado
5. Bisagras apertura 120°
6. Aberturas pretaladradas: Gran capacidad de entrada de cables
7. Junta de sellado: Permite un elevado grado de protección
- 8, Espárragos de fijación placa de montaje

F5	Referencia	Dimensiones Alto x Ancho x Fondo (mm)	Cerraduras	Bisagras	Entradas cables	Grosor chapa (mm)	P.V.P.
	JXF-2520/15	250x200x150	1	2	A	1,2	45,10€
	JXF-3025/15	300x250x150	1	2	B	1,2	47,30€
	JXF-3025/20	300x250x200	1	2	B	1,2	50,40€
	JXF-3030/15	300x300x150	1	2	B	1,2	49,40€
	JXF-3030/20	300x300x200	1	2	B	1,2	54,60€
	JXF-3040/15	300x400x150	1	2	B	1,2	54,60€
	JXF-3040/20	300x400x200	1	2	B	1,2	60,90€
	JXF-4030/15	400x300x150	1	2	B	1,2	54,60€
	JXF-4030/20	400x300x200	1	2	B	1,2	60,90€
	JXF-4040/20	400x400x200	1	2	B	1,2	75,20€
	JXF-4050/15	400x500x150	1	2	B	1,2	88,20€
	JXF-4050/20	400x500x200	1	2	B	1,2	96,60€
	JXF-4050/25	400x500x250	1	2	B	1,2	102,90€
	JXF-4060/25	400x600x250	1	2	B	1,2	116,30€
	JXF-5040/15	500x400x150	2	2	B	1,2	88,20€
	JXF-5040/20	500x400x200	2	2	B	1,2	96,60€
	JXF-5040/25	500x400x250	2	2	B	1,2	102,90€
	JXF-5050/25	500x500x250	2	2	B	1,2	123,20€
	JXF-6040/15	600x400x150	2	2	B	1,2	93,40€
	JXF-6040/20	600x400x200	2	2	B	1,2	102,90€
	JXF-6040/25	600x400x250	2	2	B	1,2	115,50€
	JXF-6050/15	600x500x150	2	2	C	1,2	100,80€
	JXF-6050/20	600x500x200	2	2	C	1,2	110,30€
	JXF-6050/25	600x500x250	2	2	C	1,2	113,40€
	JXF-6060/25	600x600x250	2	2	C	1,2	123,60€
	JXF-6060/30	600x600x300	2	2	C	1,2	129,00€
	JXF-7050/15	700x500x150	2	2	C	1,5	120,80€
	JXF-7050/20	700x500x200	2	2	C	1,5	134,40€
	JXF-7050/25	700x500x250	2	2	C	1,5	136,40€
	JXF-7050/30	700x500x300	2	2	C	1,5	138,60€
	JXF-8060/20	800x600x200	2	2	C	1,5	203,70€
	JXF-8060/25	800x600x250	2	2	C	1,5	220,50€
	JXF-8060/30	800x600x300	2	2	C	1,5	237,30€
	JXF-8060/40	800x600x400	2	2	C	1,5	257,50€
	JXF-8080/20	800x800x200	2	2	C	1,5	286,40€
	JXF-8080/30	800x800x300	2	2	C	1,5	298,00€
	JXF-10060/25	1000x600x250	3	3	C	1,5	281,40€
	JXF-10060/30	1000x600x300	3	3	C	1,5	294,00€
	JXF-10060/40	1000x600x400	3	3	C	1,5	315,00€
	JXF-10060/45	1000x600x450	3	3	C	1,5	351,80€
	JXF-10080/25	1000x800x250	3	3	D	1,5	309,80€
	JXF-10080/30	1000x800x300	3	3	D	1,5	345,50€
	JXF-10080/40	1000x800x400	3	3	D	1,5	362,30€
	JXF-10080/45	1000x800x450	3	3	D	1,5	446,30€
	JXF-100100/30	1000x1000x300	3	3	D	1,5	469,90€
	JXF-12080/25	1200x800x250	3	3	D	1,5	351,80€
	JXF-12080/30	1200x800x300	3	3	D	1,5	409,50€
	JXF-12080/40	1200x800x400	3	3	D	1,5	459,90€
	JXF-12080/45	1200x800x450	3	3	D	1,5	478,80€
	JXF-120100/30	1200x1000x300	3	3	D	1,5	577,10€

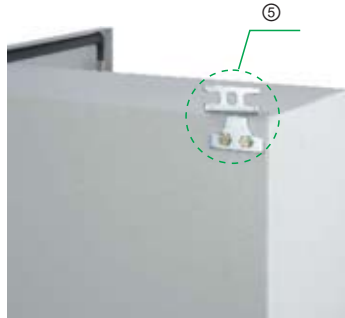
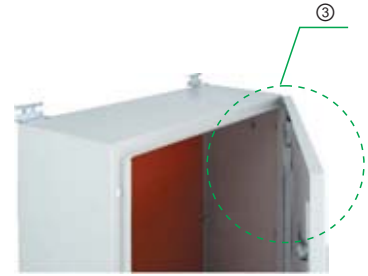
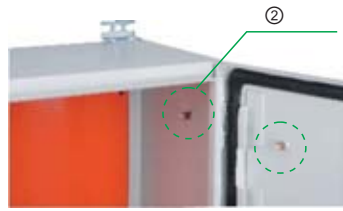

1. Bisagras interiores de duraluminio
2. Unión de tierra entre caja y puerta
3. Detalle del cierre
4. Entrada de cables, protegida con junta de goma
5. Orejas de fijación a pared

Nota: Barra de unión entre cierres de puerta a partir de 800mm.

Nota: Bajo demanda pueden suministrarse placas de montaje de mayor grosor.

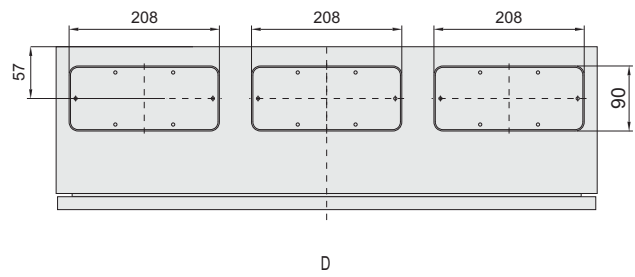
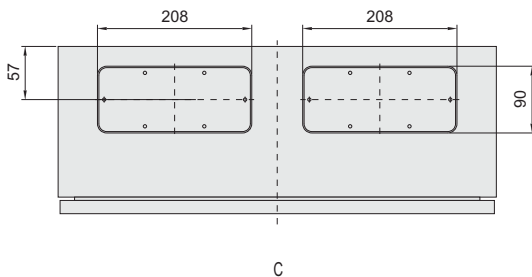
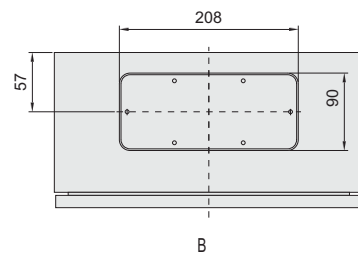
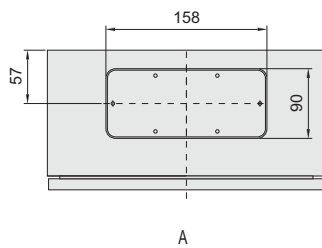

Dimensiones de los cuadros

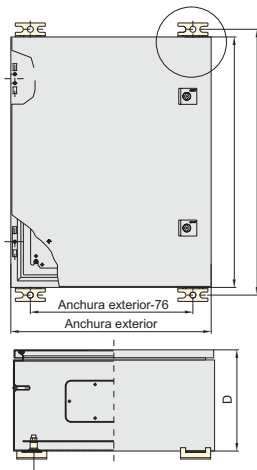

Dimensiones de las placas de montaje

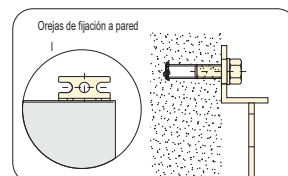
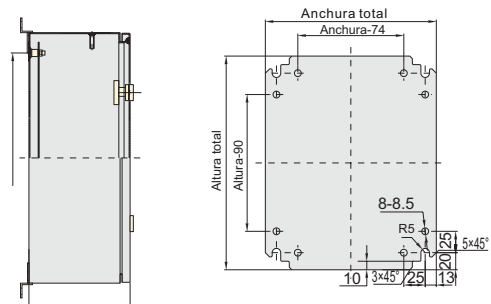

DIN/DINS

Armarios de empotrar y de superficie



Versiones	Empotrar y superficie
Puertas	Opaca y Transparente
Ancho	580mm
Módulos	24 a 192
Filas	1 a 8
Grado de protección	IP30

- * Totalmente desmontables, con cableados accesibles desde el frontal.
- * Tapas de entrada de cables superior e inferior.
- * Cierre con llave
- * Puerta reversible (apertura a derecha o a izquierda)
- * Color RAL-9001
- * Acabado con pintura Epoxi microtexturado.
- * Chapa 10/10
- * KIT para montaje de ICP's (el kit se suministra montado)

DIN/ICP

Armarios de empotrar y de superficie



Versiones	Empotrar
Puertas	Opaca
Ancho	365mm
Módulos (con ICP)	24, 32, 48
Módulos (sin ICP)	32, 48, 64
Filas	1 a 8
Grado de protección	IP40

- * Placa frontal y puerta desmontables.
- * Entrada de cables superior, inferior y lateral.
- * Cierre con pestillo
- * Puerta reversible (apertura a derecha o a izquierda)
- * Color RAL-9001
- * Acabado con pintura Epoxi microtexturado.
- * Chapa 10/10

DIN

Armarios de empotrar

1 a 8 filas - 24 a 192 módulos

- Facilidad de montaje del marco mediante cuatro tornillos
- Cristal de seguridad en armarios con puerta transparente
- Manipulación fuera del lugar de instalación con el fondo del armario independiente del marco y las tapas
- Fondo en chapa galvanizada para resistir las más adversas condiciones de pared
- Fondo reducido: 160mm
- Guia Din reforzada

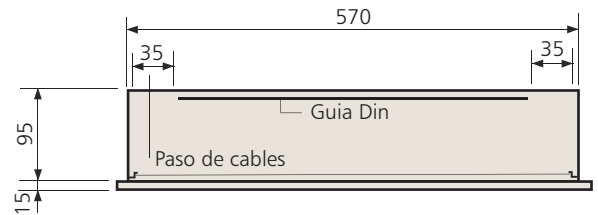
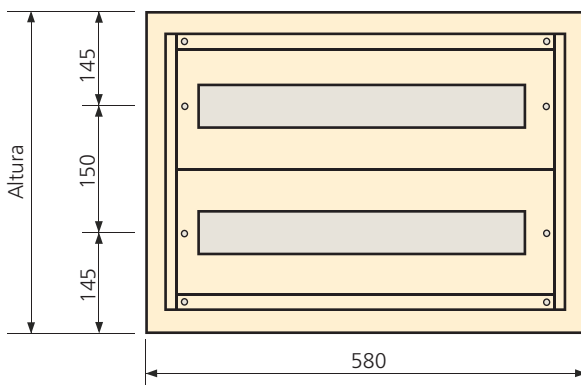

**CONJUNTO DE PLACA DE MONTAJE
+ TAPA FRONTAL CIEGA DE 300mm**

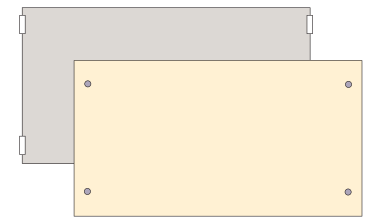

Armarios de empotrar, sin ICP

F5	Dimensiones (Alto x Ancho x Fondo)	Número de Filas	Número de Polos	Referencia Puerta Opaca	P.V.P.	Referencia Puerta Transparente	P.V.P.
	300 x 580 x 95mm	1	24	DIN/1-PN	160,80€	DIN/1-PT	201,00€
	450 x 580 x 95mm	2	48	DIN/2-PN	176,10€	DIN/2-PT	222,10€
	600 x 580 x 95mm	3	72	DIN/3-PN	214,20€	DIN/3-PT	289,10€
	750 x 580 x 95mm	4	96	DIN/4-PN	250,80€	DIN/4-PT	338,50€
	900 x 580 x 95mm	5	120	DIN/5-PN	287,30€	DIN/5-PT	387,90€
	1050 x 580 x 95mm	6	144	DIN/6-PN	329,10€	DIN/6-PT	444,20€
	1200 x 580 x 95mm	7	168	DIN/7-PN	387,10€	DIN/7-PT	522,60€
	1350 x 580 x 95mm	8	192	DIN/8-PN	441,30€	DIN/8-PT	601,00€

Armarios de empotrar, con ICP

F5	Dimensiones (Alto x Ancho x Fondo)	Número de Filas y Polos	Referencia Puerta Opaca	P.V.P.	Referencia Puerta Transparente	P.V.P.
	300 x 580 x 95mm	1x24=24	DIN/1-PN	160,80€	DIN/1-PT	201,00€
	450 x 580 x 95mm	2x12=24+ICP	DIN/2-PN+ICP	232,10€	DIN/2-PT+ICP	292,50€
	600 x 580 x 95mm	2x12+1x24=48+ICP	DIN/3-PN+ICP	282,20€	DIN/3-PT+ICP	380,70€
	750 x 580 x 95mm	2x12+2x24=72+ICP	DIN/4-PN+ICP	331,50€	DIN/4-PT+ICP	445,90€
	900 x 580 x 95mm	2x12+3x24=96+ICP	DIN/5-PN+ICP	378,50€	DIN/5-PT+ICP	511,00€
	1050 x 580 x 95mm	2x12+4x24=120+ICP	DIN/6-PN+ICP	433,50€	DIN/6-PT+ICP	585,10€
	1200 x 580 x 95mm	2x12+5x24=144+ICP	DIN/7-PN+ICP	509,90€	DIN/7-PT+ICP	688,70€
	1350 x 580 x 95mm	2x12+6x24=168+ICP	DIN/8-PN+ICP	581,30€	DIN/8-PT+ICP	791,70€

Nota: Si el cliente lo solicita, pueden sustituirse dos placas para módulos Din por una placa ciega con placa de montaje interna

DINS

Armarios de superficie

1 a 8 filas - 24 a 192 módulos

- Facilidad de montaje del marco mediante cuatro tornillos
- Cristal de seguridad en armarios con puerta transparente
- Manipulación fuera del lugar de instalación con el fondo del armario independiente del marco y las tapas
- Techo y suelo desmontables para facilitar la entrada y salida de cables
- Zona de paso para cables o canaleta: 40mm
- Guia Din reforzada

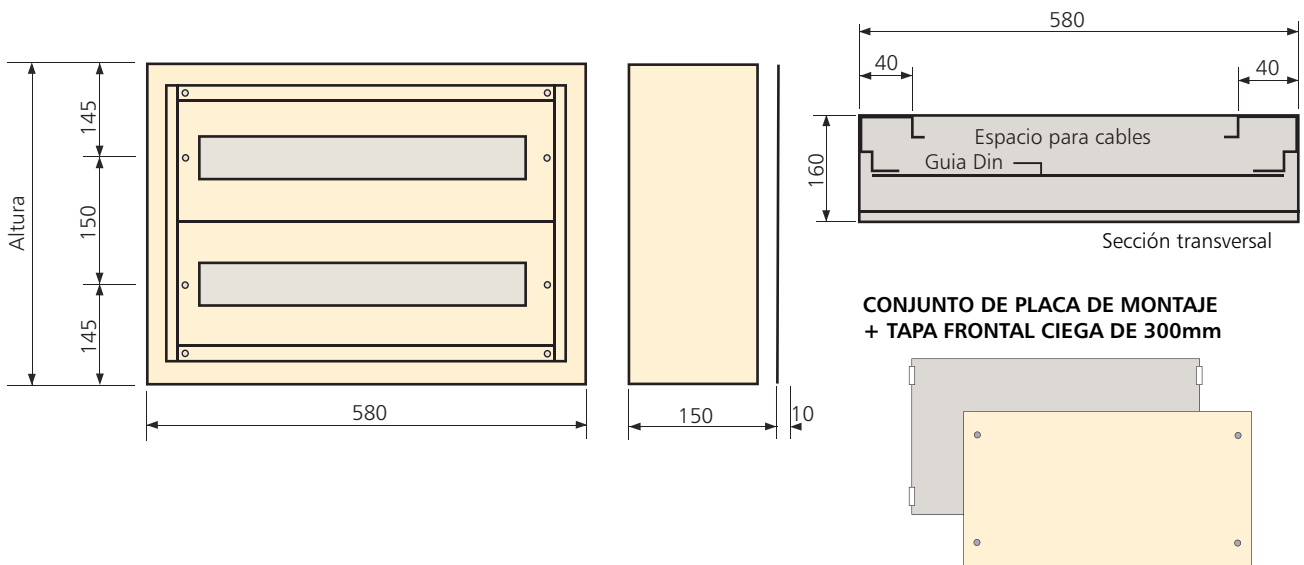

Armarios de superficie, sin ICP

F5	Dimensiones (Alto x Ancho x Fondo)	Número de Filas	Número de Polos	Referencia Puerta Opaca	P.V.P.	Referencia Puerta Transparente	P.V.P.
	300 x 580 x 160mm	1	24	DINS/1-PN	185,00€	DINS/1-PT	205,10€
	450 x 580 x 160mm	2	48	DINS/2-PN	201,90€	DINS/2-PT	237,50€
	600 x 580 x 160mm	3	72	DINS/3-PN	232,80€	DINS/3-PT	300,00€
	750 x 580 x 160mm	4	96	DINS/4-PN	303,40€	DINS/4-PT	364,90€
	900 x 580 x 160mm	5	120	DINS/5-PN	338,30€	DINS/5-PT	402,40€
	1050 x 580 x 160mm	6	144	DINS/6-PN	358,20€	DINS/6-PT	482,80€
	1200 x 580 x 160mm	7	168	DINS/7-PN	421,40€	DINS/7-PT	568,00€
	1350 x 580 x 160mm	8	192	DINS/8-PN	484,60€	DINS/8-PT	653,30€

Armarios de superficie, con ICP

F5	Dimensiones (Alto x Ancho x Fondo)	Número de Filas y Polos	Referencia Puerta Opaca	P.V.P.	Referencia Puerta Transparente	P.V.P.
	300 x 580 x 160mm	1x24=24	DINS/1-PN	185,00€	DINS/1-PT	205,10€
	450 x 580 x 160mm	2x12=24+ICP	DINS/2-PN+ICP	265,90€	DINS/2-PT+ICP	312,90€
	600 x 580 x 160mm	2x12+1x24=48+ICP	DINS/3-PN+ICP	306,70€	DINS/3-PT+ICP	395,20€
	750 x 580 x 160mm	2x12+2x24=72+ICP	DINS/4-PN+ICP	399,60€	DINS/4-PT+ICP	480,70€
	900 x 580 x 160mm	2x12+3x24=96+ICP	DINS/5-PN+ICP	445,70€	DINS/5-PT+ICP	530,00€
	1050 x 580 x 160mm	2x12+4x24=120+ICP	DINS/6-PN+ICP	470,00€	DINS/6-PT+ICP	636,10€
	1200 x 580 x 160mm	2x12+5x24=144+ICP	DINS/7-PN+ICP	555,10€	DINS/7-PT+ICP	748,30€
	1350 x 580 x 160mm	2x12+6x24=168+ICP	DINS/8-PN+ICP	638,60€	DINS/8-PT+ICP	860,60€

Nota: Si el cliente lo solicita, pueden sustituirse dos placas para módulos Din por una placa ciega con placa de montaje interna

KIT ICP de 2 y 4 POLOS
 PARA ARMARIOS CHINT
 TIPOS DIN Y DINS CON
 PUERTA DE CRISTAL O
 DE CHAPA



DIN/1 & DINS/1
 1 FILA - 24 MÓDULOS

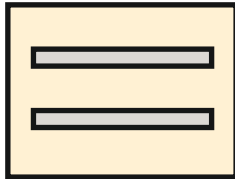
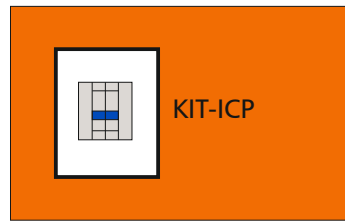

DIN/2 & DINS/2
 2x24 = 48 módulos

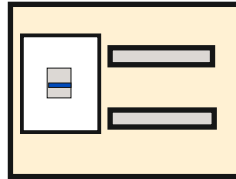

DIN/2 & DINS/2
 2x12 = 24 módulos+ICP

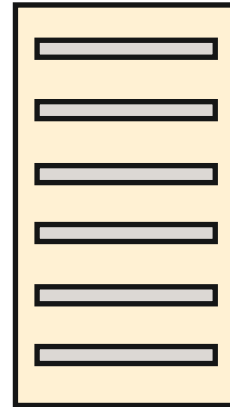

DIN/6 & DINS/6
 6x24 = 144 módulos

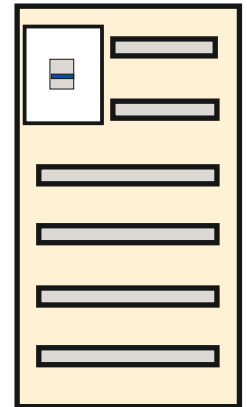

DIN/6 & DINS/6
 2x12+4x24 = 120 mód.+ICP

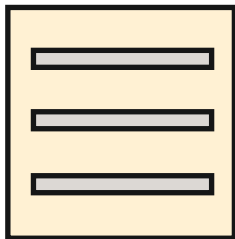

DIN/3 & DINS/3
 3x24 = 72 módulos

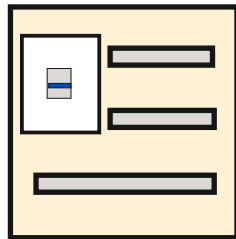

DIN/3 & DINS/3
 2x12+1x24 = 48 mód.+ICP

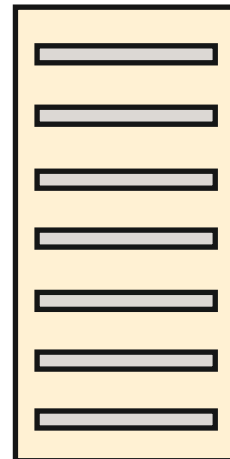

DIN/7 & DINS/7
 7x24 = 168 módulos

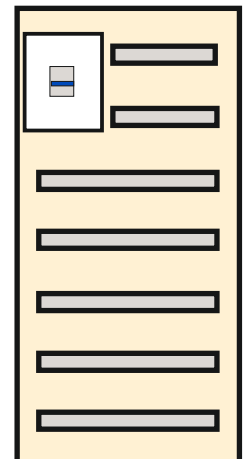

DIN/7 & DINS/7
 2x12+5x24 = 144 mód.+ICP

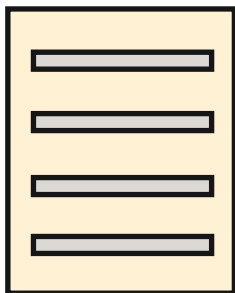

DIN/4 & DINS/4
 4x24 = 96 módulos

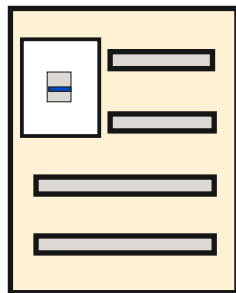

DIN/4 & DINS/4
 2x12+2x24 = 72 mód.+ICP

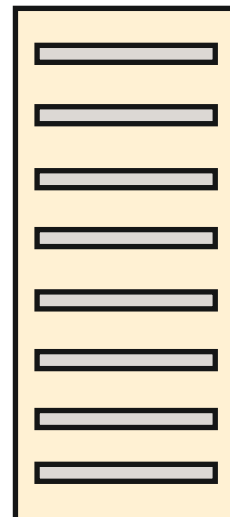

DIN/8 & DINS/8
 8x24 = 192 módulos

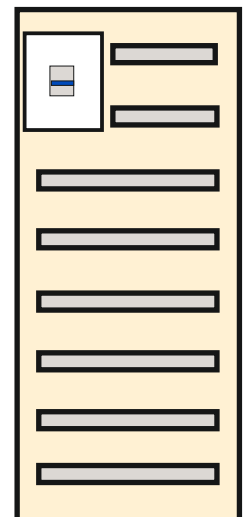

DIN/8 & DINS/8
 2x12+6x24 = 168 mód.+ICP

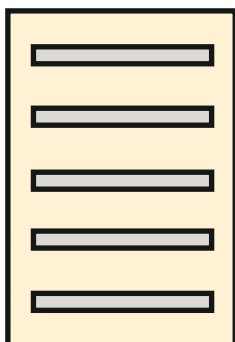

DIN/5 & DINS/5
 5x24 = 120 módulos

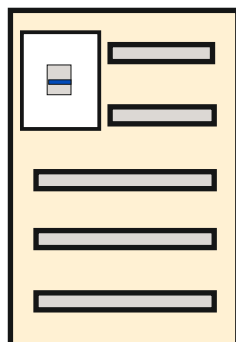

DIN/4 & DINS/4
 2x12+3x24 = 96 mód.+ICP

DIN/ICP

Armarios compactos de empotrar

- Facilidad de montaje del marco mediante cuatro tornillos
- Todos los modelos con puerta opaca
- Fondo en chapa galvanizada para resistir las más adversas condiciones de pared
- Puerta reversible (apertura a derecha o izquierda)
- Cierre con pestillo
- Guía Din



ARMARIOS DE EMPOTRAR - CON ICP 24, 32 y 48 MÓDULOS

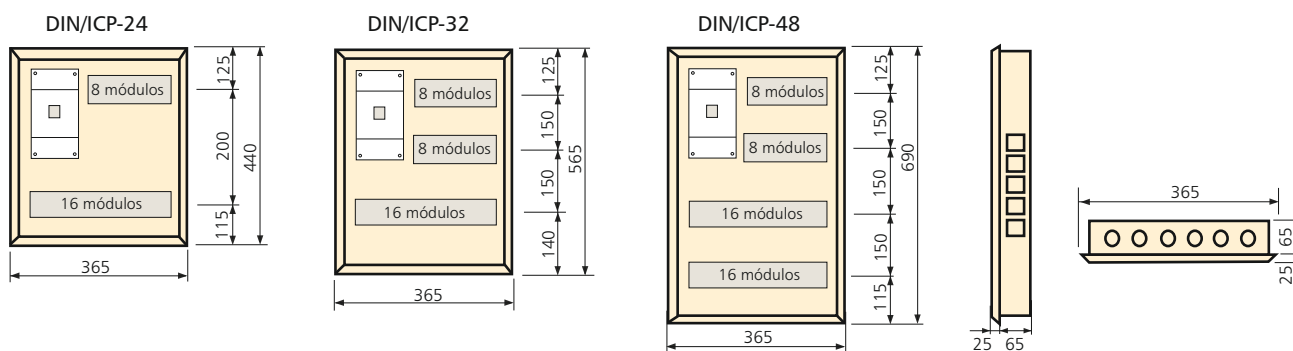

ARMARIOS DE EMPOTRAR - 32, 48, 64 MÓDULOS

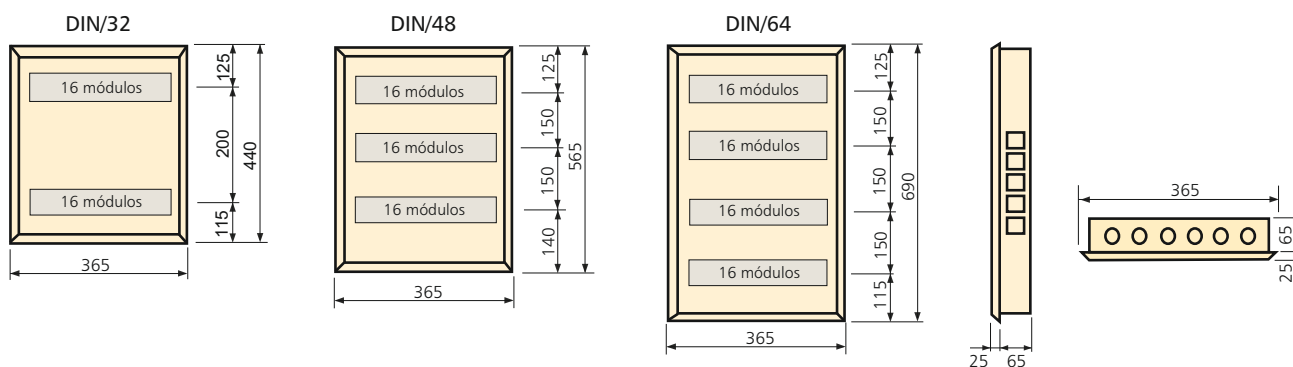

F5	Dimensiones (Alto x Ancho x Fondo)	Número de Filas	Número de módulos	Referencia Puerta Opaca	P.V.P.
	440 x 365 x 65mm	1x8+1x16	24+ICP	DIN/ICP-24	88,70€
	565 x 365 x 65mm	2x8+1x16	32+ICP	DIN/ICP-32	110,50€
	690 x 365 x 65mm	2x8+2x16	48+ICP	DIN/ICP-48	119,30€
	440 x 365 x 65mm	2x16	32	DIN/32	82,65€
	565 x 365 x 65mm	3x16	48	DIN/48	101,10€
	690 x 365 x 65mm	4x16	64	DIN/64	110,20€

ALBA
Armarios de distribución
hasta 630A



- * Dos anchos: 650mm y 1000mm
 En las medidas de 1650mm y 1950mm se incluye, de serie, el zócalo
- * Puertas: Normal y Transparente
- * Armarios apilables en ambos sentidos (superior y lateral)
- * Totalmente desmontables con sólo quitar 4 tornillos
- * Techo, suelo y laterales desmontables por deslizamiento (sin tornillos)
- * Chasis modular pivotante para facilitar el trabajo en taller u obra
- * Gran capacidad para cableado: 80mm en las zonas de bajada de cables para el montaje de canaleta, en caso necesario
- * Cierre de seguridad, escamoteable, con llave
- * En armarios con puerta transparente el cristal se monta sobre molduras laterales, con visión total interior
- * Acabado con pintura Epoxi RAL9001 microtexturado
- * Capacidad normal: 24 o 40 polos por fila y 10 polos en los pasillos laterales



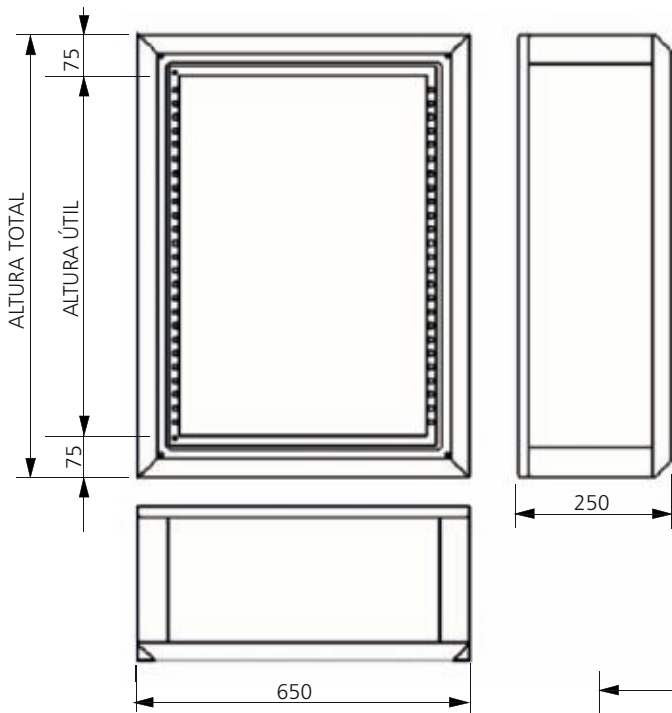

ARMARIOS DE ALTURA: 750, 1050, 1350mm

Altura total (mm)	Altura útil (mm)
750	600
1050	900
1350	1200

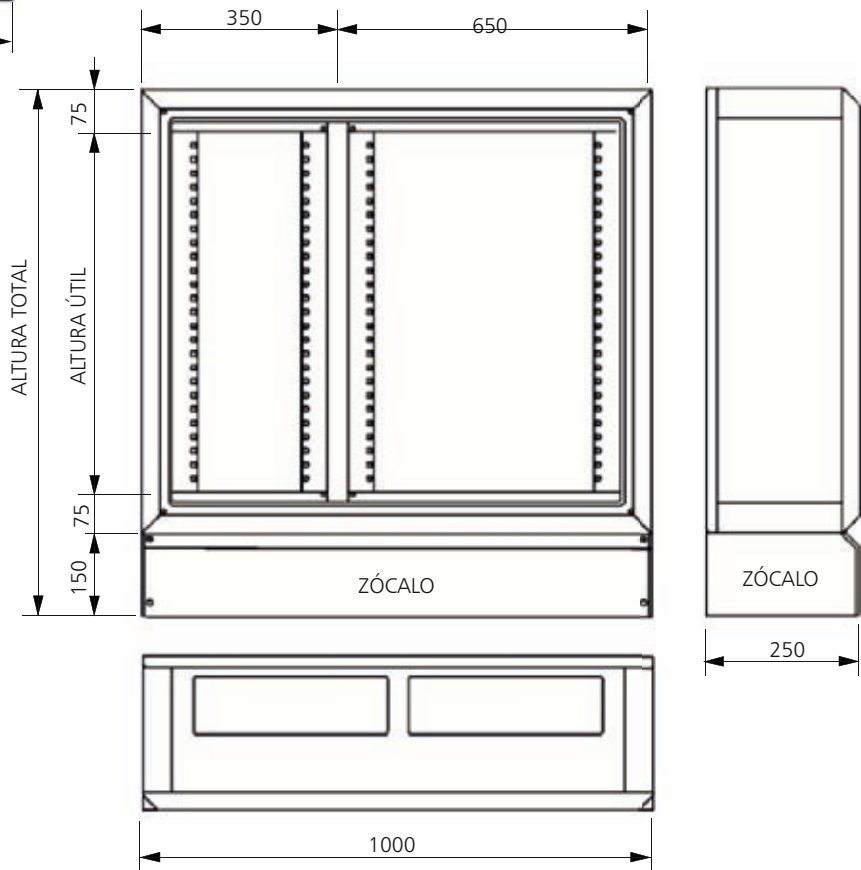

ARMARIOS DE ALTURA: 1650, 1950mm (más zócalo)

Altura total (mm)	Altura útil (mm)	Altura con zócalo (mm)
1650	1500	1800
1950	1800	2100

Armarios de 650mm de ancho - Sin pasillo lateral

F5	Altura exterior	Altura útil	Módulos de 50mm	Anchura exterior	Pasillo lateral	Puerta Opaca		Puerta Transparente	
						Referencia	P.V.P.	Referencia	P.V.P.
	750mm	600mm	12	650mm	No	ALBA/76PN	324,00€	ALBA/76PT	380,60€
	1050mm	900mm	18	650mm	No	ALBA/106PN	404,10€	ALBA/106PT	474,60€
	1350mm	1200mm	24	650mm	No	ALBA/136PN	548,30€	ALBA/136PT	644,00€
	1650mm	1500mm	30	650mm	No	ALBA/166PN (*)	833,30€	ALBA/166PT (*)	978,80€
	1950mm	1800mm	36	650mm	No	ALBA/196PN (*)	936,60€	ALBA/196PT (*)	1.100,20€

Armarios de 950mm de ancho - Sin pasillo lateral

F5	Altura exterior	Altura útil	Módulos de 50mm	Anchura exterior	Pasillo lateral	Puerta Opaca		Puerta Transparente	
						Referencia	P.V.P.	Referencia	P.V.P.
	1050mm	900mm	18	950mm	No	ALBA/100PN	696,60€	ALBA/100PT	751,80€
	1350mm	1200mm	24	950mm	No	ALBA/130PN	935,50€	ALBA/130PT	999,00€
	1650mm	1500mm	30	950mm	No	ALBA/160PN (*)	1.276,90€	ALBA/160PT (*)	1.388,50€
	1950mm	1800mm	36	950mm	No	ALBA/190PN (*)	1.435,20€	ALBA/190PT (*)	1.560,70€

Armarios de 950mm de ancho - Con pasillo lateral

F5	Altura exterior	Altura útil	Módulos de 50mm	Anchura exterior	Pasillo lateral	Puerta Opaca		Puerta Transparente	
						Referencia	P.V.P.	Referencia	P.V.P.
	1050mm	900mm	18	950mm	Si	ALBA/101PN	696,60€	ALBA/101PT	751,80€
	1350mm	1200mm	24	950mm	Si	ALBA/131PN	935,50€	ALBA/131PT	999,00€
	1650mm	1500mm	30	950mm	Si	ALBA/161PN (*)	1.276,90€	ALBA/161PT (*)	1.388,50€
	1950mm	1800mm	36	950mm	Si	ALBA/191PN (*)	1.435,20€	ALBA/191PT (*)	1.560,70€

Nota: Los armarios marcado (*) se suministran con el zócalo incluido

Placas frontales para elementos modulares Din

F5	Anchura	Altura	Packs de placas	Módulos DIN	Referencia	P.V.P.
	350mm	150mm	1 placa	1x10	ALBA/TR3-3	16,80€
	350mm	200mm	1 placa	1x10	ALBA/TR3-4	19,30€
	650mm	150mm	1 placa	1x24	ALBA/TR6-3	15,20€
	650mm	200mm	1 placa	1x24	ALBA/TR6-4	17,50€
	950mm	150mm	1 placa	1x40	ALBA/TR10-3	17,50€
	950mm	200mm	1 placa	1x40	ALBA/TR10-4	20,10€



Nota: Todas las placas se suministran con soportes interiores y tornillería.
 - Guías Din incluidas en las placas sueltas
 - Guías Din incluidas en los packs

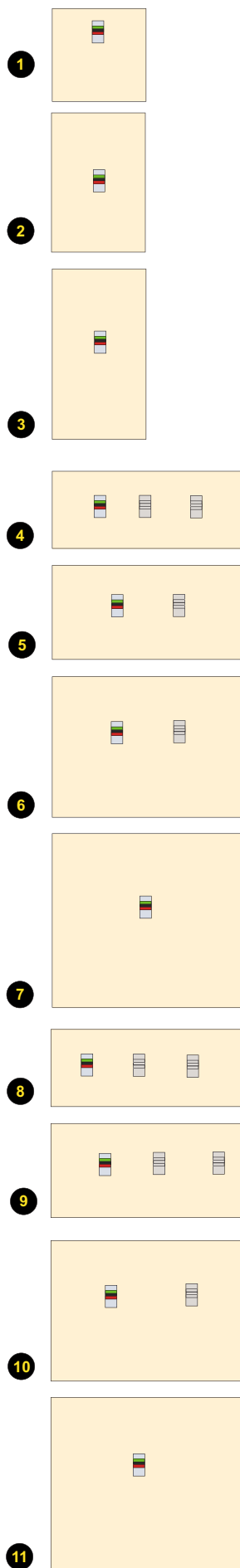

Placas frontales y soporte interior para montaje de interruptores en caja moldeada

F5	Placa	Anchura	Altura	Montaje interruptores	Módulos de 50mm	Interruptores CHINT NM8	Referencia	
	1	350mm	350mm	Vertical	6	125/250A	ALBA/TPSV3-6	32,00€
	2	350mm	450mm	Vertical	9	400A	ALBA/TPSV3-9	42,10€
	3	350mm	550mm	Vertical	11	630A	ALBA/TPSV3-11	63,40€
	4	650mm	250mm	Vertical	5	125A	ALBA/TPSV6-5	40,00€
	5	650mm	350mm	Vertical	6	250A	ALBA/TPSV6-6	45,10€
	6	650mm	450mm	Vertical	9	400A	ALBA/TPSV6-9	53,40€
	7	650mm	550mm	Vertical	11	630A	ALBA/TPSV6-11	69,30€
	8	950mm	250mm	Vertical	5	125A	ALBA/TPSV9-5	43,40€
	9	950mm	350mm	Vertical	6	250A	ALBA/TPSV9-6	58,20€
	10	950mm	450mm	Vertical	9	400A	ALBA/TPSV9-9	67,70€
	11	950mm	550mm	Vertical	11	630A	ALBA/TPSV9-11	84,20€
	12	650mm	250mm	Horizontal	5	250A	ALBA/TPSH6-5	40,00€
	13	650mm	350mm	Horizontal	6	400/630A	ALBA/TPSH6-6	45,10€
	14	950mm	250mm	Horizontal	5	250A	ALBA/TPSH9-5	43,40€
	15	950mm	350mm	Horizontal	6	400/630A	ALBA/TPSH9-6	58,20€

Nota: Las placas para interruptores de caja moldeada se suministran con soportes y tornillería



Interruptor montaje vertical

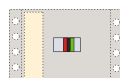

Interruptor montaje horizontal



Pre-troquelado para montaje interruptor vertical

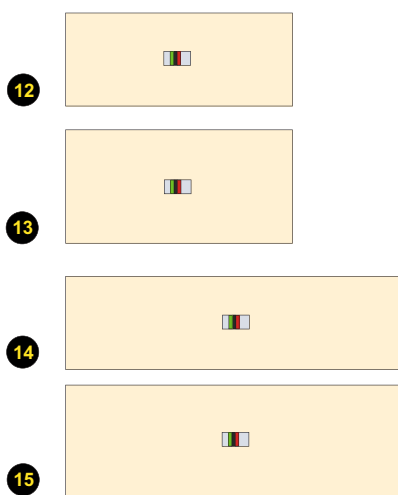

Placas de montaje interiores

F5	Anchura	Altura	Módulos de 50mm	Referencia	P.V.P.
	350mm	200mm	4	ALBA/PS3/200	22,00€
	350mm	350mm	6	ALBA/PS3/300	24,20€
	650mm	200mm	4	ALBA/PS6/200	23,40€
	650mm	350mm	6	ALBA/PS6/300	29,20€
	650mm	450mm	9	ALBA/PS6/450	36,50€
	650mm	550mm	11	ALBA/PS6/550	45,60€
	950mm	200mm	4	ALBA/PS9/200	30,42€
	950mm	350mm	6	ALBA/PS9/300	38,00€
	950mm	450mm	9	ALBA/PS9/450	47,40€
	950mm	550mm	11	ALBA/PS9/550	59,30€



Nota: Las placas ciegas se suministran con soportes interiores y tornillería.
No se incluyen guías o placa de montaje interna.

Guia Din

F5	Anchura	Guia Fija	P.V.P.	Guia Regulable	P.V.P.
	350mm	ALBA/SA3	14,50€	ALBA/SA3R	17,50€
	650mm	ALBA/SA6	15,90€	ALBA/SA6R	18,90€
	950mm	ALBA/SA9	16,70€	ALBA/SA9R	19,70€

Guia "U"

F5	Anchura	Guia Fija	P.V.P.	Guia Regulable	P.V.P.
	350mm	ALBA/SEC3	6,60€	ALBA/SEC3R	9,60€
	650mm	ALBA/SEC6	7,90€	ALBA/SEC6R	10,90€
	950mm	ALBA/SEC9	13,40€	ALBA/SEC9R	16,40€

Placas frontales lisas

F5	Anchura	Altura	Módulos de 50mm	Referencia	P.V.P.
	350mm	100mm	2	ALBA/TP3-2	13,80€
	350mm	150mm	3	ALBA/TP3-3	16,80€
	350mm	200mm	4	ALBA/TP3-4	19,70€
	350mm	250mm	5	ALBA/TP3-5	22,70€
	350mm	350mm	6	ALBA/TP3-6	25,60€
	350mm	400mm	8	ALBA/TP3-8	28,70€
	350mm	550mm	11	ALBA/TP3-11	32,20€
	650mm	100mm	2	ALBA/TP6-2	14,50€
	650mm	150mm	3	ALBA/TP6-3	17,30€
	650mm	200mm	4	ALBA/TP6-4	20,90€
	650mm	250mm	5	ALBA/TP6-5	23,60€
	650mm	350mm	6	ALBA/TP6-6	23,30€
	650mm	400mm	8	ALBA/TP6-8	27,10€
	650mm	550mm	11	ALBA/TP6-11	33,20€
	950mm	100mm	2	ALBA/TP9-2	15,10€
	950mm	150mm	3	ALBA/TP9-3	18,30€
	950mm	200mm	4	ALBA/TP9-4	21,60€
	950mm	250mm	5	ALBA/TP9-5	24,80€
	950mm	350mm	6	ALBA/TP9-6	28,00€
	950mm	400mm	8	ALBA/TP9-8	31,30€
	950mm	550mm	11	ALBA/TP9-11	35,10€

Zócalos de 150mm con tapa frontal

F5	Anchura	Altura	Módulos de 50mm	Referencia	P.V.P.
	650mm	150mm	3	ALBA/ZOC6	74,50€
	1000mm	150mm	3	ALBA/ZOC10	99,20€

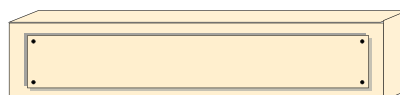



CMI
Armarios industriales
(sistema compacto)

Versiones:

- Chasis modular
- Puerta interior



- * Los armarios de la serie CMI están contruídos con estructura compacta de gran resistencia.
- * Grado de protección IP559
- * Pliegue vierteaguas que presiona la junta de neopreno ignífugo.
- * Color RAL-7032. Bajo demanda pueden suministrarse en otros colores RAL.
- *Personalización de los armarios, según indicaciones del cliente: (mecanización de puertas, laterales, techo y suelo; medidas especiales, etc.).
- * En los tipos de puerta transparente, el cristal se monta sobre un perfil exclusivo, con un acabado elegante y seguro.
- * Los modelos de más de 1000mm de anchura se suministran con dos puertas frontales opacas y no poseen opción de puerta de transparente.
- * Cierre de doble bit con embellecedor y tres puntos de anclaje.
- * Sistema completo de placas frontales, con guía Din incluida, para aparatos modulares.
- * Sistema completo de placas frontales, con placa de soporte incluida, para aparatos en caja moldeada hasta 630A.
- * Personalización de la puerta interior, bajo demanda.
- * Gama completa de placas internas y accesorios para montaje de automatismos.

PUERTA NORMAL (CON PLACA DE MONTAJE)

F5	Alto	Ancho	Fondo	Referencia	P.V.P.
	1200	800	300	CMI-283-PN/PM	664,20€
	1200	800	400	CMI-284-PN/PM	688,30€
	1200	1000	300	CMI-213-PN/PM	839,40€
	1200	1000	400	CMI-214-PN/PM	868,40€
	1400	800	300	CMI-483-PN/PM	826,10€
	1400	800	400	CMI-484-PN/PM	835,20€
	1400	1000	300	CMI-413-PN/PM	1.047,80€
	1400	1000	400	CMI-414-PN/PM	1.085,80€
	1600	800	300	CMI-683-PN/PM	813,30€
	1600	800	400	CMI-684-PN/PM	935,00€
	1600	1000	300	CMI-613-PN/PM	1.027,90€
	1600	1000	400	CMI-614-PN/PM	1.100,70€
	1600	1200	300	CMI-623-PN/PM	1.252,80€
	1600	1200	400	CMI-624-PN/PM	1.365,80€
	1800	800	300	CMI-883-PN/PM	879,70€
	1800	800	400	CMI-884-PN/PM	985,10€
	1800	1000	400	CMI-814-PN/PM	1.265,20€
	1800	1200	400	CMI-824-PN/PM	1.477,00€
	2000	800	400	CMI-084-PN/PM	1.215,10€
	2000	1000	400	CMI-014-PN/PM	1.379,20€
	2000	1200	400	CMI-024-PN/PM	1.544,60€

PUERTA NORMAL (SIN PLACA DE MONTAJE)

F5	Alto	Ancho	Fondo	Referencia	P.V.P.
	1200	800	300	CMI-283-PN	582,80€
	1200	800	400	CMI-284-PN	604,00€
	1200	1000	300	CMI-213-PN	704,90€
	1200	1000	400	CMI-214-PN	730,50€
	1400	800	300	CMI-483-PN	650,00€
	1400	800	400	CMI-484-PN	664,60€
	1400	1000	300	CMI-413-PN	851,80€
	1400	1000	400	CMI-414-PN	882,70€
	1600	800	300	CMI-683-PN	698,30€
	1600	800	400	CMI-684-PN	767,40€
	1600	1000	300	CMI-613-PN	861,20€
	1600	1000	400	CMI-614-PN	938,50€
	1600	1200	300	CMI-623-PN	970,00€
	1600	1200	400	CMI-624-PN	1.099,20€
	1800	800	300	CMI-883-PN	792,10€
	1800	800	400	CMI-884-PN	837,10€
	1800	1000	400	CMI-814-PN	1.054,70€
	1800	1200	400	CMI-824-PN	1.216,00€
	2000	800	400	CMI-084-PN	1.047,00€
	2000	1000	400	CMI-014-PN	1.193,60€
	2000	1200	400	CMI-024-PN	1.294,60€

PUERTA TRANSPARENTE (SIN PLACA DE MONTAJE)

F5	Alto	Ancho	Fondo	Referencia	P.V.P.
	1200	800	300	CMI-283-PT	783,40€
	1200	800	400	CMI-284-PT	807,60€
	1200	1000	300	CMI-213-PT	943,80€
	1200	1000	400	CMI-214-PT	973,00€
	1400	800	300	CMI-483-PT	860,40€
	1400	800	400	CMI-484-PT	938,60€
	1400	1000	300	CMI-413-PT	1.012,20€
	1400	1000	400	CMI-414-PT	1.104,20€
	1600	800	300	CMI-683-PT	959,30€
	1600	800	400	CMI-684-PT	994,30€
	1600	1000	300	CMI-613-PT	1.182,60€
	1600	1000	400	CMI-614-PN	1.169,80€
	1800	800	300	CMI-883-PT	1.061,30€
	1800	800	400	CMI-884-PT	1.144,80€
	1800	1000	400	CMI-814-PT	1.346,80€
	2000	800	400	CMI-084-PT	1.390,20€
	2000	1000	400	CMI-014-PT	1.635,00€

Placas de montaje

F5	Alto	Ancho	Referencia	P.V.P.
	1200	800	CMI/PL-128	190,80€
	1200	1000	CMI/PL-121	200,70€
	1400	800	CMI/PL-148	195,70€
	1400	1000	CMI/PL-141	227,40€
	1600	800	CMI/PL-168	198,70€
	1600	1000	CMI/PL-161	243,00€
	1600	1200	CMI/PL-162	321,00€
	1800	800	CMI/PL-188	200,40€
	1800	1000	CMI/PL-181	237,30€
	1800	1200	CMI/PL-182	274,70€
	2000	800	CMI/PL-208	218,50€
	2000	1000	CMI/PL-201	271,70€
	2000	1200	CMI/PL-202	297,80€

Chasis modular (incluye tapas frontales y guías Din)

F5	Alto	Ancho	Referencia	P.V.P.
	1200	800	CMI/CH-128	229,90€
	1200	1000	CMI/CH-121	259,80€
	1400	800	CMI/CH-148	278,00€
	1400	1000	CMI/CH-141	314,20€
	1600	800	CMI/CH-168	310,30€
	1600	1000	CMI/CH-161	350,60€
	1800	800	CMI/CH-188	346,70€
	1800	1000	CMI/CH-181	391,80€
	2000	800	CMI/CH-208	396,70€
	2000	1000	CMI/CH-201	448,30€

800mm de anchura = 30 polos por fila
 1000mm de anchura = 40 polos por fila





Puerta interior

F5	Alto	Ancho	Referencia	P.V.P.
	1200	800	CMI/PI-128	248,60€
	1200	1000	CMI/PI-121	285,40€
	1400	800	CMI/PI-148	272,30€
	1400	1000	CMI/PI-141	315,20€
	1600	800	CMI/PI-168	295,90€
	1600	1000	CMI/PI-161	345,00€
	1800	800	CMI/PI-188	319,50€
	1800	1000	CMI/PI-181	374,70€
	2000	800	CMI/PI-208	354,30€
	2000	1000	CMI/PI-201	404,60€

Placa de montaje parcial

(incluye 4 carriles deslizantes de fijación al armario y accesorios)

F5	Alto armario	Ancho placa	Referencia	P.V.P.
	800	300	CMI/PMP-30/80	85,00€
	800	450	CMI/PMP-45/80	103,10€
	1000	300	CMI/PMP-30/100	89,70€
	1000	450	CMI/PMP-45/100	101,30€
	1200	300	CMI/PMP-30/120	95,40€
	1200	450	CMI/PMP-45/120	107,70€

Placa de montaje parcial para chasis modular

(incluye 4 carriles deslizantes de fijación al chasis y accesorios)

F5	Alto armario	Ancho placa	Referencia	P.V.P.
	800	300	CMI/PMD-8/300	45,30€
	800	450	CMI/PMD-8/450	48,90€
	800	600	CMI/PMD-8/600	52,80€
	1000	300	CMI/PMD-10/300	50,70€
	1000	450	CMI/PMD-10/450	54,80€
	1000	600	CMI/PMD-10/600	59,20€
	1200	300	CMI/PMD-12/300	56,80€
	1200	450	CMI/PMD-12/450	61,30€
	1200	600	CMI/PMD-12/600	66,20€

Bastidor montaje interruptores en caja moldeada

- 2 elementos verticales en "L" y dos horizontales en "U"

(incluye 4 carriles deslizantes de fijación al armario y accesorios)

F5	Alto	Ancho placa	Referencia	P.V.P.
	200	600,700	CMI/BFA-20/67	68,00€
	300	600,700	CMI/BFA-30/67	70,40€
	450	600,700	CMI/BFA-45/67	72,20€
	200	800,900,1000	CMI/BFA-20/890	81,40€
	300	800,900,1000	CMI/BFA-30/890	84,10€
	450	800,900,1000	CMI/BFA-45/890	85,30€



Conjunto de soportes de fijación para interruptores en caja moldeada (incluye 2 soportes en "U" y escuadras de fijación)

F5	Referencia	P.V.P.
	BFA/ES	85,30€



Conjunto de montantes verticales interiores, para fijación de placas parciales, perfiles, etc

F5	Alto armario	Referencia	P.V.P.
	1200	PV-12	67,70€
	1400	PV-14	69,90€
	1600	PV-16	74,30€
	1800	PV-18	78,80€
	2000	PV-20	83,50€



Zócalo

F5	Ancho	Fondo	Referencia H=100mm	P.V.P.	Referencia H=200mm	P.V.P.
	800	300	CMI/ZOC-83/100	95,10€	CMI/ZOC-83/200	174,90€
	800	400	CMI/ZOC-84/100	95,80€	CMI/ZOC-84/200	182,70€
	1000	300	CMI/ZOC-103/100	108,00€	CMI/ZOC-103/200	201,90€
	1000	400	CMI/ZOC-104/100	109,40€	CMI/ZOC-104/200	217,50€
	1200	300	CMI/ZOC-123/100	116,40€	CMI/ZOC-123/200	219,60€
	1200	400	CMI/ZOC-124/100	120,60€	CMI/ZOC-124/200	231,80€

Tejadillo



F5	Ancho	Fondo	Referencia	P.V.P.
	800	300	CMI/TJ-83	108,40€
	800	400	CMI/TJ-84	121,80€
	1000	300	CMI/TJ-103	124,30€
	1000	400	CMI/TJ-104	141,90€
	1200	300	CMI/TJ-123	135,00€
	1200	400	CMI/TJ-124	155,00€

Cierre de maneta abatible



F5	Alto armario	Referencia	P.V.P.
	Cierre de doble bit	TCE	91,80€
	Cierre con llave	TCL	108,30€
	Transformación cierre	TCN/E(*)	48,10€
	Transformación cierre	TCN/EL(**)	62,50€

(*) Normal a escamoteable sin llave.
(**) Normal a escamoteable con llave.

Omega para aparatos modulares



F5	Ancho armario	Longitud omega	Capacidad	Referencia	P.V.P.
	700	432	24 polos	OMA-24	25,20€
	800	576	32 polos	OMA-32	29,70€
	900	648	36 polos	OMA-36	34,90€
	1000	756	42 polos	OMA-42	41,10€

Guías Din



F5	Alto armario	Referencia	P.V.P.
	Guía Din estandar	PD-N	5,30€
	Guía Din reforzada	PD-R	8,70€
	Gui Din aluminio	PD-AL	10,90€

CM Armarios industriales componibles



Versiones:
- Chasis modular
- Puerta interior



- * Los armarios de la serie CM están construídos con perfil de armadura en "U" de 2,5mm de grosor, el cual dota al armario de una protección y resistencia excepcionales.
- * Grado de protección IP-45 (bajo demanda IP55).
- * El sistema de armadura de los armarios CM ofrece:
 - Óptima estanqueidad, con grado de protección IP55
 - Simplificación del trabajo gracias a la rapidez de montaje
 - Máximo aprovechamiento del espacio
 - Múltiples aplicaciones en los campos de la electricidad y de la electrónica
- * Sistema de cierre con cuatro puntos de anclaje, con accionamiento por el exterior de la zona de influencia de la aparamenta.
- * En los tipos con puerta transparente, el cristal va montado sobre un cerco metálico, obteniendo con ello un acabado elegante y seguro.
- * Placa de montaje solapada con dos pliegues laterales y fabricada en chapa galvanizada.
- * Pintura de resina de poliéster (Epoxi), previo desengrase y fosfatado mediante plaforización.
- * Sistema completo de placas frontales, con guía Din incluída, para aparatos modulares.
- * Sistema completo de soportes para montajes de interruptores automáticos en caja moldeada o en bastidor.
- * Personalización de la puerta interior, bajo demanda.
- * Gama completa de placas internas y accesorios para montaje de automatismos



PUERTA NORMAL

F5	Alto	Ancho	Fondo	Referencia	P.V.P.
	1800	800	400	CM-184-PN	1.001,80€
	1800	800	600	CM-186-PN	1.069,40€
	1800	1000	400	CM-114-PN	1.186,00€
	1800	1000	600	CM-116-PN	1.241,10€
	2000	600	400	CM-264-PN	1.007,70€
	2000	600	500	CM-265-PN	1.026,30€
	2000	600	600	CM-266-PN	1.044,80€
	2000	600	700	CM-267-PN	1.062,90€
	2000	600	800	CM-268-PN	1.096,50€
	2000	700	400	CM-274-PN	1.037,90€
	2000	700	500	CM-275-PN	1.056,00€
	2000	700	600	CM-276-PN	1.075,20€
	2000	700	700	CM-277-PN	1.094,50€
	2000	700	800	CM-278-PN	1.113,80€
	2000	800	400	CM-284-PN	1.052,40€
	2000	800	500	CM-285-PN	1.057,60€
	2000	800	600	CM-286-PN	1.079,50€
	2000	800	700	CM-287-PN	1.105,30€
	2000	800	800	CM-288-PN	1.131,00€
	2000	900	400	CM-294-PN	1.102,50€
	2000	900	500	CM-295-PN	1.124,10€
	2000	900	600	CM-296-PN	1.145,60€
	2000	900	700	CM-297-PN	1.167,20€
	2000	900	800	CM-298-PN	1.188,80€
	2000	1000	400	CM-214-PN	1.174,90€
	2000	1000	500	CM-215-PN	1.192,70€
	2000	1000	600	CM-216-PN	1.207,40€
	2000	1000	700	CM-217-PN	1.227,00€
	2000	1000	800	CM-218-PN	1.246,60€

PUERTA TRANSPARENTE

F5	Alto	Ancho	Fondo	Referencia	P.V.P.
	1800	800	400	CM-184-PT	1.214,00€
	1800	800	600	CM-186-PT	1.269,20€
	1800	1000	400	CM-114-PT	1.437,10€
	1800	1000	600	CM-116-PT	1.466,20€
	2000	600	400	CM-264-PT	1.202,80€
	2000	600	500	CM-265-PT	1.201,10€
	2000	600	600	CM-266-PT	1.235,10€
	2000	600	700	CM-267-PT	1.266,40€
	2000	600	800	CM-268-PT	1.297,80€
	2000	700	400	CM-274-PT	1.252,80€
	2000	700	500	CM-275-PT	1.273,90€
	2000	700	600	CM-276-PT	1.295,00€
	2000	700	700	CM-277-PT	1.319,50€
	2000	700	800	CM-278-PT	1.346,60€
	2000	800	400	CM-284-PT	1.302,80€
	2000	800	500	CM-285-PT	1.305,40€
	2000	800	600	CM-286-PT	1.328,00€
	2000	800	700	CM-287-PT	1.361,70€
	2000	800	800	CM-288-PT	1.395,50€
	2000	900	400	CM-294-PT	1.360,70€
	2000	900	500	CM-295-PT	1.384,50€
	2000	900	600	CM-296-PT	1.408,20€
	2000	900	700	CM-297-PT	1.432,00€
	2000	900	800	CM-298-PT	1.455,80€
	2000	1000	400	CM-214-PT	1.429,20€
	2000	1000	500	CM-215-PT	1.470,80€
	2000	1000	600	CM-216-PT	1.497,60€
	2000	1000	700	CM-217-PT	1.506,90€
	2000	1000	800	CM-218-PT	1.516,10€



Puerta interior

F5	Alto	Ancho	Referencia	P.V.P.
	1800	800	CM/PI-18	333,00€
	1800	1000	CM/PI-11	371,00€
	2000	600	CM/PI-26	321,00€
	2000	700	CM/PI-27	332,10€
	2000	800	CM/PI-28	342,30€
	2000	900	CM/PI-29	361,60€
	2000	1000	CM/PI-21	380,80€

**Placa de montaje parcial
(incluye 4 carriles deslizantes de fijación al armario y accesorios)**

F5	Ancho armario	Alto placa	Referencia	P.V.P.
	600	300	CM/PMP-30/60	79,50€
	600	450	CM/PMP-45/60	87,00€
	600	600	CM/PMP-60/60	96,70€
	700	300	CM/PMP-30/70	81,90€
	700	450	CM/PMP-45/70	90,70€
	700	600	CM/PMP-60/70	101,80€
	800	300	CM/PMP-30/80	85,00€
	800	450	CM/PMP-45/80	103,10€
	800	600	CM/PMP-60/80	106,10€
	900	300	CM/PMP-30/90	87,30€
	900	450	CM/PMP-45/90	97,00€
	900	600	CM/PMP-60/90	109,40€
	1000	300	CM/PMP-30/100	89,60€
	1000	450	CM/PMP-45/100	101,30€
	1000	600	CM/PMP-60/100	117,80€

**Bastidor para fijación de interruptores en caja moldeada
(incluye 4 carriles deslizantes de fijación al armario, y accesorios)**



F5	Alto	Ancho	Referencia	P.V.P.
	200	800	CM/BFA-20/67	68,00€
	300	1000	CM/BFA-30/67	70,40€
	450	600	CM/BFA-45/67	72,20€
	200	700	CM/BFA-20/890	81,40€
	300	800, 900, 1000	CM/BFA-30/890	84,00€
	450	900	CM/BFA-45/890	85,30€

Cierres

F5	Referencia	Descripción	P.V.P.
	TCE	Cierre de maneta abatible, de doble bit	91,80€
	TCL	Cierre de maneta abatible, con llave	108,30€
	TCN-E	Transformación cierre normal a escamoteable sin llave	48,10€
	TCN-EL	Transformación cierre normal a escamoteable sin llave	62,50€



**Conjunto de soportes independientes para fijación de interruptores en caja moldeada
(2 soportes "U" + 2 escuadras)**

F5	Referencia	P.V.P.
	BFA/ES	85,30€

Conjunto de 2 laterales

F5	Alto	Ancho	Referencia	P.V.P.
	1800	400	CM/LT-14	187,00€
	1800	600	CM/LT-16	213,40€
	2000	400	CM/LT-24	199,00€
	2000	500	CM/LT-25	236,60€
	2000	600	CM/LT-26	261,20€
	2000	700	CM/LT-27	284,90€
	2000	800	CM/LT-28	308,70€

Placas de montaje

F5	Alto	Ancho	Referencia	P.V.P.
	1800	400	CM/PL-18	206,90€
	1800	600	CM/PL-11	245,10€
	2000	400	CM/PL-26	189,60€
	2000	500	CM/PL-27	207,60€
	2000	600	CM/PL-28	225,60€
	2000	700	CM/PL-29	253,10€
	2000	800	CM/PL-21	258,60€

Zócalos (altura: 100 y 200mm)

F5	Ancho	Fondo	Referencia	P.V.P.	Referencia	P.V.P.
	600	400	CM/ZOC-64/100	95,60€	CM/ZOC-64/200	173,60€
	600	500	CM/ZOC-65/100	97,70€	CM/ZOC-65/200	173,80€
	600	600	CM/ZOC-66/100	104,90€	CM/ZOC-66/200	196,40€
	600	700	CM/ZOC-67/100	106,90€	CM/ZOC-67/200	200,80€
	600	800	CM/ZOC-68/100	108,90€	CM/ZOC-68/200	214,60€
	700	400	CM/ZOC-74/100	96,90€	CM/ZOC-74/200	185,40€
	700	500	CM/ZOC-75/100	100,90€	CM/ZOC-75/200	193,00€
	700	600	CM/ZOC-76/100	106,30€	CM/ZOC-76/200	203,50€
	700	700	CM/ZOC-77/100	111,80€	CM/ZOC-77/200	214,10€
	700	800	CM/ZOC-78/100	117,30€	CM/ZOC-78/200	224,50€
	800	400	CM/ZOC-84/100	101,10€	CM/ZOC-84/200	192,80€
	800	500	CM/ZOC-85/100	104,20€	CM/ZOC-85/200	203,40€
	800	600	CM/ZOC-86/100	107,90€	CM/ZOC-86/200	212,40€
	800	700	CM/ZOC-87/100	116,80€	CM/ZOC-87/200	223,50€
	800	800	CM/ZOC-88/100	125,80€	CM/ZOC-88/200	234,60€
	900	400	CM/ZOC-94/100	107,00€	CM/ZOC-94/200	209,20€
	900	500	CM/ZOC-95/100	111,30€	CM/ZOC-95/200	217,50€
	900	600	CM/ZOC-96/100	116,80€	CM/ZOC-96/200	228,30€
	900	700	CM/ZOC-97/100	121,80€	CM/ZOC-97/200	238,00€
	900	800	CM/ZOC-98/100	126,80€	CM/ZOC-98/200	251,00€
	1000	400	CM/ZOC-104/100	115,40€	CM/ZOC-104/200	229,60€
	1000	500	CM/ZOC-105/100	118,40€	CM/ZOC-105/200	232,60€
	1000	600	CM/ZOC-106/100	120,10€	CM/ZOC-106/200	246,90€
	1000	700	CM/ZOC-107/100	123,90€	CM/ZOC-107/200	257,20€
	1000	800	CM/ZOC-108/100	127,80€	CM/ZOC-108/200	270,90€

Chasis modular

(incluye todas las tapas (ciegas, Din, etc) necesarias para el montaje requerido, según las especificaciones del cliente)

F5	Alto	Ancho	Polos x fila	Referencia	P.V.P.
	1800	800	30	CM/CH-18	346,70€
	1800	1000	40	CM/CH-11	400,80€
	2000	600	20	CM/CH-26	343,50€
	2000	700	24	CM/CH-27	370,10€
	2000	800	30	CM/CH-28	396,70€
	2000	900	36	CM/CH-29	426,10€
	2000	1000	40	CM/CH-21	463,60€

Chasis modular con puerta pivotante

F5	Alto	Ancho	Referencia	P.V.P.
	1800	800	CM/CHP-18	532,80€
	1800	1000	CM/CHP-11	595,20€
	2000	600	CM/CHP-26	486,70€
	2000	700	CM/CHP-27	517,10€
	2000	800	CM/CHP-28	554,50€
	2000	900	CM/CHP-29	588,60€
	2000	1000	CM/CHP-21	630,90€



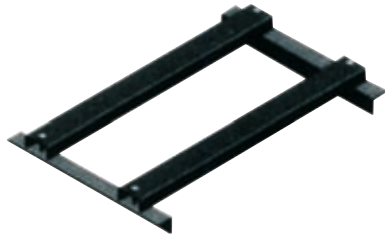

Bastidor para la fijación de interruptores en caja moldeada (incluye piezas de fijación a armario)

F5	Ancho	Fondo	Referencia	P.V.P.
	600	400	CM/BFAB-64	120,70€
	600	500	CM/BFAB-65	123,10€
	600	600	CM/BFAB-66	125,60€
	600	700	CM/BFAB-67	128,10€
	600	800	CM/BFAB-68	130,70€
	700	400	CM/BFAB-74	130,40€
	700	500	CM/BFAB-75	132,90€
	700	600	CM/BFAB-76	135,60€
	700	700	CM/BFAB-77	138,30€
	700	800	CM/BFAB-78	141,10€
	800	400	CM/BFAB-84	140,80€
	800	500	CM/BFAB-85	143,60€
	800	600	CM/BFAB-86	146,40€
	800	700	CM/BFAB-87	149,40€
	800	800	CM/BFAB-88	152,40€
	900	400	CM/BFAB-94	152,10€
	900	500	CM/BFAB-95	155,10€
	900	600	CM/BFAB-96	158,20€
	900	700	CM/BFAB-97	161,30€
	900	800	CM/BFAB-98	164,60€
	1000	400	CM/BFAB-104	164,20€
	1000	500	CM/BFAB-105	167,50€
	1000	600	CM/BFAB-106	170,80€
	1000	700	CM/BFAB-107	174,20€
	1000	800	CM/BFAB-108	177,70€



Bandeja de entrada de clavos inferior con tapas deslizantes

F5	Ancho	Fondo	Referencia	P.V.P.
	600	400	CM/TEC-64	45,20€
	600	500	CM/TEC-65	52,50€
	600	600	CM/TEC-66	53,50€
	600	700	CM/TEC-67	61,00€
	600	800	CM/TEC-68	68,50€
	700	400	CM/TEC-74	48,80€
	700	500	CM/TEC-75	53,50€
	700	600	CM/TEC-76	58,70€
	700	700	CM/TEC-77	65,40€
	700	800	CM/TEC-78	72,00€
	800	400	CM/TEC-84	52,50€
	800	500	CM/TEC-85	54,60€
	800	600	CM/TEC-86	63,90€
	800	700	CM/TEC-87	69,70€
	800	800	CM/TEC-88	75,60€
	900	400	CM/TEC-94	55,80€
	900	500	CM/TEC-95	60,60€
	900	600	CM/TEC-96	68,10€
	900	700	CM/TEC-97	75,40€
	900	800	CM/TEC-98	82,70€
	1000	400	CM/TEC-104	59,20€
	1000	500	CM/TEC-105	66,70€
	1000	600	CM/TEC-106	72,30€
	1000	700	CM/TEC-107	81,10€
	1000	800	CM/TEC-108	89,80€

Accesorios comunes a armarios CMI y CM

F5	Referencia	Descripción	P.V.P.
	CM/BZ	Bandeja base para armarios sin zócalo (todas las medidas)	57,00€
	PP	Bandeja Portaplanos A4	14,80€
	LLP	Maneta puerta, plástica	2,50€
	LLM	Maneta puerta metálica	3,00€
	CAN	Cáncamos elevación armario (2 unidades)	8,60€

Referencia	P.V.P.	Fam.	Pag.	Emb.
125083	26,60 €	F1	42	1
125084	49,20 €	F1	42	1
125085	49,20 €	F1	42	1
125086	56,40 €	F1	42	1
125087	68,80 €	F1	42	1
125088	68,80 €	F1	42	1
125090	76,10 €	F1	42	1
125091	76,10 €	F1	42	1
125092	79,10 €	F1	42	1
125093	79,10 €	F1	42	1
125094	86,00 €	F1	42	1
125095	86,00 €	F1	42	1
125120	17,80 €	F1	41	1
125121	36,20 €	F1	41	1
125122	39,60 €	F1	41	1
125123	48,90 €	F1	41	1
125124	64,10 €	F1	41	1
125125	21,00 €	F1	42	1
125126	23,00 €	F1	42	1
125127	35,00 €	F1	42	1
125128	67,00 €	F1	42	1
125129	89,00 €	F1	42	1
125130	131,00 €	F1	42	1
125131	25,00 €	F1	42	1
125132	27,00 €	F1	42	1
125133	40,00 €	F1	42	1
125134	79,00 €	F1	42	1
125135	101,00 €	F1	42	1
125136	153,00 €	F1	42	1
125137	21,20 €	F1	42	1
125138	35,00 €	F1	42	1
125139	54,00 €	F1	42	1
125140	78,30 €	F1	42	1
125141	101,20 €	F1	42	1
125143	23,20 €	F1	42	1
125144	41,40 €	F1	42	1
125145	64,00 €	F1	42	1
125146	89,70 €	F1	42	1
125147	126,30 €	F1	42	1
125149	6,00 €	F1	42	1
125152	6,50 €	F1	42	1
125154	8,70 €	F1	42	1
125157	9,80 €	F1	42	1
125160	10,80 €	F1	42	1
125162	12,50 €	F1	42	1
125601	19,13 €	F1	38	1
125602	23,43 €	F1	38	1
125603	26,13 €	F1	38	1
125604	35,93 €	F1	38	1
125605	66,23 €	F1	38	1
125606	85,83 €	F1	38	1
125608	36,13 €	F1	38	1
125609	48,03 €	F1	38	1
125610	86,33 €	F1	38	1
125611	111,23 €	F1	38	1
125613	40,33 €	F1	38	1
125614	55,10 €	F1	38	1
125615	51,23 €	F1	38	1
125616	66,33 €	F1	38	1
125617	80,83 €	F1	38	1
125618	66,43 €	F1	38	1
125619	86,63 €	F1	38	1
125620	104,43 €	F1	38	1
125621	116,23 €	F1	38	1
125622	145,83 €	F1	38	1
125623	299,23 €	F1	38	1
125624	149,13 €	F1	38	1
125625	177,43 €	F1	38	1
125626	358,73 €	F1	38	1
125627	24,53 €	F1	38	1

Referencia	P.V.P.	Fam.	Pag.	Emb.
125628	32,13 €	F1	38	1
125629	27,93 €	F1	38	1
125630	38,23 €	F1	38	1
125631	15,99 €	F1	38	1
125632	15,99 €	F1	38	1
125633	15,99 €	F1	38	1
125634	15,99 €	F1	38	1
125635	31,10 €	F1	38	1
125636	33,47 €	F1	38	1
125637	33,47 €	F1	38	1
125638	33,47 €	F1	38	1
125639	51,80 €	F1	38	1
125640	51,80 €	F1	38	1
125655	86,43 €	F1	37	1
125656	92,13 €	F1	37	1
125657	104,23 €	F1	37	1
125659	69,03 €	F1	37	1
125660	75,63 €	F1	37	1
125661	92,93 €	F1	37	1
125662	94,23 €	F1	37	1
125663	97,43 €	F1	37	1
125664	112,13 €	F1	37	1
125671	21,10 €	F1	39	1
125672	25,50 €	F1	39	1
125673	32,10 €	F1	39	1
125674	27,10 €	F1	39	1
125675	32,10 €	F1	39	1
125676	36,70 €	F1	39	1
125677	58,50 €	F1	39	1
125678	32,10 €	F1	39	1
125679	39,40 €	F1	39	1
125680	43,20 €	F1	39	1
125681	21,30 €	F1	39	1
125682	27,20 €	F1	39	1
125683	31,00 €	F1	39	1
125684	55,30 €	F1	39	1
125685	29,20 €	F1	39	1
125686	30,80 €	F1	39	1
125687	35,10 €	F1	39	1
125692	53,30 €	F1	37	1
125693	60,40 €	F1	37	1
125694	61,30 €	F1	37	1
125695	53,30 €	F1	37	1
125696	60,40 €	F1	37	1
125697	61,30 €	F1	37	1
125698	53,30 €	F1	37	1
125699	60,40 €	F1	37	1
125702	80,80 €	F1	37	1
125703	91,40 €	F1	37	1
125704	111,50 €	F1	37	1
125705	80,80 €	F1	37	1
125706	91,40 €	F1	37	1
125707	111,50 €	F1	37	1
125708	41,40 €	F1	37	1
125709	41,40 €	F1	37	1
125709	41,40 €	F1	37	1
125710	64,40 €	F1	39	1
125711	85,10 €	F1	39	1
125712	114,40 €	F1	39	1
125713	84,50 €	F1	39	1
125714	104,80 €	F1	39	1
125715	139,00 €	F1	39	1
125716	85,40 €	F1	39	1
125717	104,80 €	F1	39	1
125718	136,70 €	F1	39	1
125720	41,40 €	F1	37	1
125722	69,30 €	F1	37	1
125723	93,20 €	F1	37	1
125724	94,50 €	F1	37	1
125725	111,40 €	F1	37	1

Referencia	P.V.P.	Fam.	Pag.	Emb.
125688/1	424,50 €	F1	37	1
125688/2	424,50 €	F1	37	1
125688/3	424,50 €	F1	37	1
125689/1	553,70 €	F1	37	1
125689/2	553,70 €	F1	37	1
125689/3	553,70 €	F1	37	1
125690/1	720,40 €	F1	37	1
125690/2	720,40 €	F1	37	1
125690/3	720,40 €	F1	37	1
125690/4	720,40 €	F1	37	1
125690/5	720,40 €	F1	37	1
125691/1	923,30 €	F1	37	1
AD1/12- 110	42,40 €	F2	57	1
AD1/12- 230	42,40 €	F2	57	1
AD1/12- 24	42,40 €	F2	57	1
AD1/12- 400	42,40 €	F2	57	1
AD1/12- 48	42,40 €	F2	57	1
AD1/18- 110	47,80 €	F2	57	1
AD1/18- 230	47,80 €	F2	57	1
AD1/18- 24	47,80 €	F2	57	1
AD1/18- 400	47,80 €	F2	57	1
AD1/18- 48	47,80 €	F2	57	1
ALBA/100PN	696,60 €	F5	111	1
ALBA/100PT	751,80 €	F5	111	1
ALBA/101PN	696,60 €	F5	111	1
ALBA/101PT	751,80 €	F5	111	1
ALBA/106PN	404,10 €	F5	111	1
ALBA/106PT	474,60 €	F5	111	1
ALBA/130PN	935,50 €	F5	111	1
ALBA/130PT	999,00 €	F5	111	1
ALBA/131PN	935,50 €	F5	111	1
ALBA/131PT	999,00 €	F5	111	1
ALBA/136PN	548,30 €	F5	111	1
ALBA/136PT	644,00 €	F5	111	1
ALBA/160PN	1.276,90 €	F5	111	1
ALBA/160PT	1.388,50 €	F5	111	1
ALBA/161PN	1.276,90 €	F5	111	1
ALBA/161PT	1.388,50 €	F5	111	1
ALBA/166PN	833,30 €	F5	111	1
ALBA/166PT	978,80 €	F5	111	1
ALBA/190PN	1.435,20 €	F5	111	1
ALBA/190PT	1.560,70 €	F5	111	1
ALBA/191PN	1.435,20 €	F5	111	1
ALBA/191PT	1.560,70 €	F5	111	1
ALBA/196PN	936,60 €	F5	111	1
ALBA/196PT	1.100,20 €	F5	111	1
ALBA/76PN	324,00 €	F5	111	1
ALBA/76PT	380,60 €	F5	111	1
ALBA/PACK- 101	425,70 €	F5	111	1
ALBA/PACK- 106	319,30 €	F5	111	1
ALBA/PACK- 121	510,90 €	F5	111	1
ALBA/PACK- 126	357,00 €	F5	111	1
ALBA/PACK- 46	119,00 €	F5	111	1
ALBA/PACK- 61	255,40 €	F5	111	1
ALBA/PACK- 66	178,50 €	F5	111	1
ALBA/PACK- 81	340,60 €	F5	111	1
ALBA/PACK- 86	238,00 €	F5	111	1
ALBA/PS3/200	22,00 €	F5	113	1
ALBA/PS3/300	24,20 €	F5	113	1
ALBA/PS6/200	23,40 €	F5	113	1
ALBA/PS6/300	29,20 €	F5	113	1
ALBA/PS6/450	36,50 €	F5	113	1
ALBA/PS6/550	45,60 €	F5	113	1
ALBA/PS9/200	30,42 €	F5	113	1
ALBA/PS9/300	38,00 €	F5	113	1
ALBA/PS9/450	47,40 €	F5	113	1
ALBA/PS9/550	59,30 €	F5	113	1
ALBA/SA3	14,50 €	F5	113	1
ALBA/SA3R	17,50 €	F5	113	1
ALBA/SA6	15,90 €	F5	113	1

Referencia	P.V.P.	Fam.	Pag.	Emb.
ALBA/SA6R	18,90 €	F5	113	1
ALBA/SA9	16,70 €	F5	113	1
ALBA/SA9R	19,70 €	F5	113	1
ALBA/SEC3	6,60 €	F5	113	1
ALBA/SEC3R	9,60 €	F5	113	1
ALBA/SEC6	7,90 €	F5	113	1
ALBA/SEC6R	10,90 €	F5	113	1
ALBA/SEC9	13,40 €	F5	113	1
ALBA/SEC9R	16,40 €	F5	113	1
ALBA/TP3- 11	32,20 €	F5	113	1
ALBA/TP3- 2	13,80 €	F5	113	1
ALBA/TP3- 3	16,80 €	F5	113	1
ALBA/TP3- 4	19,70 €	F5	113	1
ALBA/TP3- 5	22,70 €	F5	113	1
ALBA/TP3- 6	25,60 €	F5	113	1
ALBA/TP3- 8	28,70 €	F5	113	1
ALBA/TP6- 11	33,20 €	F5	113	1
ALBA/TP6- 2	14,50 €	F5	113	1
ALBA/TP6- 3	17,30 €	F5	113	1
ALBA/TP6- 4	20,90 €	F5	113	1
ALBA/TP6- 5	23,60 €	F5	113	1
ALBA/TP6- 6	23,30 €	F5	113	1
ALBA/TP6- 8	27,10 €	F5	113	1
ALBA/TP9- 11	35,10 €	F5	113	1
ALBA/TP9- 2	15,10 €	F5	113	1
ALBA/TP9- 3	18,30 €	F5	113	1
ALBA/TP9- 4	21,60 €	F5	113	1
ALBA/TP9- 5	24,80 €	F5	113	1
ALBA/TP9- 6	28,00 €	F5	113	1
ALBA/TP9- 8	31,30 €	F5	113	1
ALBA/TPSH6- 5	40,00 €	F5	112	1
ALBA/TPSH6- 6	45,10 €	F5	112	1
ALBA/TPSH9- 5	43,40 €	F5	112	1
ALBA/TPSH9- 6	58,20 €	F5	112	1
ALBA/TPSV3- 11	63,40 €	F5	112	1
ALBA/TPSV3- 6	32,00 €	F5	112	1
ALBA/TPSV3- 9	42,10 €	F5	112	1
ALBA/TPSV6- 11	69,30 €	F5	112	1
ALBA/TPSV6- 5	40,00 €	F5	112	1
ALBA/TPSV6- 6	45,10 €	F5	112	1
ALBA/TPSV6- 9	53,40 €	F5	112	1
ALBA/TPSV9- 11	84,20 €	F5	112	1
ALBA/TPSV9- 5	43,40 €	F5	112	1
ALBA/TPSV9- 6	58,20 €	F5	112	1
ALBA/TPSV9- 9	67,70 €	F5	112	1
ALBA/TR10- 3	17,50 €	F5	111	1
ALBA/TR10- 4	20,10 €	F5	111	1
ALBA/TR3- 3	16,80 €	F5	111	1
ALBA/TR3- 4	19,30 €	F5	111	1
ALBA/TR6- 3	15,20 €	F5	111	1
ALBA/TR6- 4	17,50 €	F5	111	1
ALBA/ZOC3	74,50 €	F5	113	1
ALBA/ZOC6	99,20 €	F5	113	1
AUX- 1	25,80 €	F4	11	1/12
BB101- 100	15,10 €	F4	29	1
BB101- 63	12,00 €	F4	29	1
BB102- 63	13,10 €	F4	29	1
BB201- 100	23,60 €	F4	29	1
BB201- 63	19,40 €	F4	29	1
BB202- 63	18,50 €	F4	29	1
BB203- 63	17,40 €	F4	29	1
BB301- 100	27,50 €	F4	29	1
BB301- 63	22,80 €	F4	29	1
BB302- 63	28,20 €	F4	29	1
BB303- 63	32,50 €	F4	29	1
BB401- 100	56,50 €	F4	29	1
BB401- 63	44,30 €	F4	29	1
BB402- 63	49,70 €	F4	29	1
BB403- 63	29,50 €	F4	29	1
BFA/ES	85,30 €	F5	118	1

Referencia	P.V.P.	Fam.	Pag.	Emb.
BH-0.66/10/0.5	12,90 €	F5	87	1
BH-0.66/15/0.5	12,90 €	F5	87	1
BH-0.66/20/0.5	12,90 €	F5	87	1
BH-0.66/25/0.5	12,90 €	F5	87	1
BH-0.66/30/0.5	12,90 €	F5	87	1
BH-0.66/40/0.5	12,90 €	F5	87	1
BH-0.66/5/0.5	12,90 €	F5	87	1
BH-0.66/50/0.5	12,90 €	F5	87	1
BH-0.66/75/0.5	12,90 €	F5	87	1
BH-0.66-100V1000/0.5	40,00 €	F5	89	1
BH-0.66-100V1200/0.5	40,00 €	F5	89	1
BH-0.66-100V1500/0.5	40,00 €	F5	89	1
BH-0.66-100V2000/0.5	49,10 €	F5	89	1
BH-0.66-100V2500/0.5	58,60 €	F5	89	1
BH-0.66-100V3000/0.5	63,40 €	F5	89	1
BH-0.66-100V600/0.5	35,70 €	F5	89	1
BH-0.66-100V750/0.5	35,70 €	F5	89	1
BH-0.66-100V800/0.5	35,70 €	F5	89	1
BH-0.66-100W1000/0.5	43,90 €	F5	91	1
BH-0.66-100W1200/0.5	43,90 €	F5	91	1
BH-0.66-100W1500/0.5	43,90 €	F5	91	1
BH-0.66-100W2000/0.5	53,70 €	F5	91	1
BH-0.66-100W2500/0.5	68,20 €	F5	91	1
BH-0.66-100W3000/0.5	65,70 €	F5	91	1
BH-0.66-100W4000/0.5	79,70 €	F5	91	1
BH-0.66-100W1000/0.5	40,00 €	F5	92	1
BH-0.66-100W1200/0.5	40,00 €	F5	92	1
BH-0.66-100W1500/0.5	40,00 €	F5	92	1
BH-0.66-100W2000/0.5	49,10 €	F5	92	1
BH-0.66-100W2500/0.5	58,60 €	F5	92	1
BH-0.66-100W3000/0.5	63,40 €	F5	92	1
BH-0.66-100W4000/0.5	85,10 €	F5	92	1
BH-0.66-100W800/0.5	35,70 €	F5	92	1
BH-0.66-120V1000/0.5	48,60 €	F5	89	1
BH-0.66-120V1200/0.5	48,60 €	F5	89	1
BH-0.66-120V1500/0.5	48,60 €	F5	89	1
BH-0.66-120V2000/0.5	56,20 €	F5	89	1
BH-0.66-120V2500/0.5	68,70 €	F5	89	1
BH-0.66-120V3000/0.5	79,50 €	F5	89	1
BH-0.66-120V4000/0.5	88,90 €	F5	89	1
BH-0.66-120V5000/0.5	99,90 €	F5	89	1
BH-0.66-120W1000/0.5	53,20 €	F5	91	1
BH-0.66-120W1200/0.5	53,20 €	F5	91	1
BH-0.66-120W1500/0.5	53,20 €	F5	91	1
BH-0.66-120W2000/0.5	64,80 €	F5	91	1
BH-0.66-120W2500/0.5	74,10 €	F5	91	1
BH-0.66-120W3000/0.5	83,50 €	F5	91	1
BH-0.66-120W4000/0.5	96,50 €	F5	91	1
BH-0.66-120W5000/0.5	110,30 €	F5	91	1
BH-0.66-120W1000/0.5	48,60 €	F5	92	1
BH-0.66-120W1200/0.5	48,60 €	F5	92	1
BH-0.66-120W1500/0.5	48,60 €	F5	92	1
BH-0.66-120W2000/0.5	56,20 €	F5	92	1
BH-0.66-120W2500/0.5	68,70 €	F5	92	1
BH-0.66-120W3000/0.5	79,50 €	F5	92	1
BH-0.66-120W4000/0.5	88,90 €	F5	92	1
BH-0.66-120W5000/0.5	99,90 €	F5	92	1
BH-0.66-20V100/1	13,10 €	F5	87	1
BH-0.66-20V75/1	13,10 €	F5	87	1
BH-0.66-20W100/1	13,10 €	F5	91	1
BH-0.66-20W150/0.5	13,10 €	F5	91	1
BH-0.66-20W200/0.5	13,10 €	F5	91	1
BH-0.66-20W75/1	13,10 €	F5	91	1
BH-0.66-30V100/0.2	16,90 €	F5	87	1
BH-0.66-30V100/0.5	14,05 €	F5	87	1
BH-0.66-30V150/0.2	16,90 €	F5	87	1
BH-0.66-30V150/0.5	14,05 €	F5	87	1
BH-0.66-30V200/0.2	16,90 €	F5	87	1
BH-0.66-30V200/0.5	14,05 €	F5	87	1
BH-0.66-30V250/0.2	16,90 €	F5	87	1

Referencia	P.V.P.	Fam.	Pag.	Emb.
BH-0.66-30V250/0.5	14,05 €	F5	87	1
BH-0.66-30V30/0.2	16,90 €	F5	87	1
BH-0.66-30V30/0.5	14,05 €	F5	87	1
BH-0.66-30V300/0.2	16,90 €	F5	87	1
BH-0.66-30V300/0.5	14,05 €	F5	87	1
BH-0.66-30V400/0.5	14,05 €	F5	87	1
BH-0.66-30V50/0.2	16,90 €	F5	87	1
BH-0.66-30V50/0.5	14,05 €	F5	87	1
BH-0.66-30V75/0.2	16,90 €	F5	87	1
BH-0.66-30V75/0.5	14,05 €	F5	87	1
BH-0.66-30W150/0.5	14,05 €	F5	91	1
BH-0.66-30W200/0.5	14,05 €	F5	91	1
BH-0.66-30W250/0.5	14,05 €	F5	91	1
BH-0.66-30W300/0.5	14,05 €	F5	91	1
BH-0.66-30W400/0.5	14,05 €	F5	91	1
BH-0.66-30W500/0.5	14,05 €	F5	91	1
BH-0.66-30W600/0.5	14,05 €	F5	91	1
BH-0.66-40V100/0.5	16,10 €	F5	88	1
BH-0.66-40V150/0.5	16,10 €	F5	88	1
BH-0.66-40V200/0.5	16,10 €	F5	88	1
BH-0.66-40V250/0.5	16,10 €	F5	88	1
BH-0.66-40V30/0.5	16,10 €	F5	88	1
BH-0.66-40V300/0.5	16,10 €	F5	88	1
BH-0.66-40V400/0.5	16,10 €	F5	88	1
BH-0.66-40V50/0.5	16,10 €	F5	88	1
BH-0.66-40V500/0.5	16,10 €	F5	88	1
BH-0.66-40V600/0.5	16,10 €	F5	88	1
BH-0.66-40V75/0.5	16,10 €	F5	88	1
BH-0.66-40V750/0.5	16,10 €	F5	88	1
BH-0.66-40V800/0.5	16,10 €	F5	88	1
BH-0.66-40V150/0.5	16,10 €	F5	88	1
BH-0.66-40V150/0.5	18,30 €	F5	90	1
BH-0.66-40V200/0.5	18,30 €	F5	90	1
BH-0.66-40V250/0.5	18,30 €	F5	90	1
BH-0.66-40V300/0.5	18,30 €	F5	90	1
BH-0.66-40V400/0.5	18,30 €	F5	90	1
BH-0.66-40V500/0.5	18,30 €	F5	90	1
BH-0.66-40V600/0.5	18,30 €	F5	90	1
BH-0.66-40V750/0.5	18,30 €	F5	90	1
BH-0.66-40V800/0.5	18,30 €	F5	90	1
BH-0.66-40W150/0.5	16,10 €	F5	91	1
BH-0.66-40W200/0.5	16,10 €	F5	91	1
BH-0.66-40W250/0.5	16,10 €	F5	91	1
BH-0.66-40W300/0.5	16,10 €	F5	91	1
BH-0.66-40W400/0.5	16,10 €	F5	91	1
BH-0.66-40W500/0.5	16,10 €	F5	91	1
BH-0.66-40W600/0.5	16,10 €	F5	91	1
BH-0.66-40W750/0.5	16,10 €	F5	91	1
BH-0.66-40W800/0.5	16,10 €	F5	91	1
BH-0.66-40W1000/0.5	16,10 €	F5	91	1
BH-0.66-40W1200/0.5	16,10 €	F5	91	1
BH-0.66-40W150/0.5	16,10 €	F5	91	1
BH-0.66-40W1500/0.5	16,10 €	F5	91	1
BH-0.66-40W200/0.5	16,10 €	F5	91	1
BH-0.66-40W250/0.5	16,10 €	F5	91	1
BH-0.66-40W300/0.5	16,10 €	F5	91	1
BH-0.66-40W400/0.5	16,10 €	F5	91	1
BH-0.66-40W500/0.5	16,10 €	F5	91	1
BH-0.66-40W600/0.5	16,10 €	F5	91	1
BH-0.66-40W750/0.5	16,10 €	F5	91	1
BH-0.66-40W800/0.5	16,10 €	F5	91	1
BH-0.66-50V1000/0.5	31,40 €	F5	88	1
BH-0.66-50V1200/0.5	31,40 €	F5	88	1
BH-0.66-50V150/0.5	28,90 €	F5	88	1
BH-0.66-50V1500/0.5	31,40 €	F5	88	1
BH-0.66-50V200/0.5	28,90 €	F5	88	1
BH-0.66-50V250/0.5	28,90 €	F5	88	1
BH-0.66-50V300/0.5	28,90 €	F5	88	1
BH-0.66-50V400/0.5	28,90 €	F5	88	1
BH-0.66-50V500/0.5	28,90 €	F5	88	1
BH-0.66-50V600/0.5	30,50 €	F5	88	1
BH-0.66-50V750/0.5	30,50 €	F5	88	1
BH-0.66-50V800/0.5	30,50 €	F5	88	1
BH-0.66-50W1000/0.5	33,40 €	F5	90	1
BH-0.66-50W1200/0.5	33,40 €	F5	90	1
BH-0.66-50W150/0.5	30,00 €	F5	90	1
BH-0.66-50W1500/0.5	33,40 €	F5	90	1
BH-0.66-50W200/0.5	30,00 €	F5	90	1
BH-0.66-50W250/0.5	30,00 €	F5	90	1
BH-0.66-50W300/0.5	30,00 €	F5	90	1

Referencia	P.V.P.	Fam.	Pag.	Emb.
BH-0.66-50W/400/0.5	30,00 €	F5	90	1
BH-0.66-50W/500/0.5	32,20 €	F5	90	1
BH-0.66-50W/600/0.5	32,20 €	F5	90	1
BH-0.66-50W/750/0.5	32,20 €	F5	90	1
BH-0.66-50W/800/0.5	32,20 €	F5	90	1
BH-0.66-50W/1000/0.5	31,40 €	F5	92	1
BH-0.66-50W/1200/0.5	31,40 €	F5	92	1
BH-0.66-50W/1500/0.5	31,40 €	F5	92	1
BH-0.66-50W/300/0.5	28,90 €	F5	92	1
BH-0.66-50W/400/0.5	28,90 €	F5	92	1
BH-0.66-50W/500/0.5	28,90 €	F5	92	1
BH-0.66-50W/600/0.5	30,50 €	F5	92	1
BH-0.66-50W/750/0.5	30,50 €	F5	92	1
BH-0.66-50W/800/0.5	30,50 €	F5	92	1
BH-0.66-60V/1000/0.5	32,00 €	F5	88	1
BH-0.66-60V/1200/0.5	33,20 €	F5	88	1
BH-0.66-60V/1500/0.5	36,10 €	F5	88	1
BH-0.66-60V/200/0.5	28,90 €	F5	88	1
BH-0.66-60V/2000/0.5	43,50 €	F5	88	1
BH-0.66-60V/250/0.5	28,90 €	F5	88	1
BH-0.66-60V/300/0.5	28,90 €	F5	88	1
BH-0.66-60V/400/0.5	28,90 €	F5	88	1
BH-0.66-60V/500/0.5	28,90 €	F5	88	1
BH-0.66-60V/600/0.5	30,60 €	F5	88	1
BH-0.66-60V/750/0.5	30,60 €	F5	88	1
BH-0.66-60V/800/0.5	30,60 €	F5	88	1
BH-0.66-60W/1000/0.5	37,20 €	F5	90	1
BH-0.66-60W/1200/0.5	38,00 €	F5	90	1
BH-0.66-60W/1500/0.5	38,00 €	F5	90	1
BH-0.66-60W/2000/0.5	38,00 €	F5	90	1
BH-0.66-60W/300/0.5	34,60 €	F5	90	1
BH-0.66-60W/400/0.5	34,60 €	F5	90	1
BH-0.66-60W/500/0.5	34,60 €	F5	90	1
BH-0.66-60W/600/0.5	35,90 €	F5	90	1
BH-0.66-60W/750/0.5	35,90 €	F5	90	1
BH-0.66-60W/800/0.5	36,10 €	F5	90	1
BH-0.66-60W/1000/0.5	37,20 €	F5	92	1
BH-0.66-60W/1200/0.5	38,00 €	F5	92	1
BH-0.66-60W/1500/0.5	38,00 €	F5	92	1
BH-0.66-60W/2000/0.5	38,00 €	F5	92	1
BH-0.66-60W/500/0.5	34,60 €	F5	92	1
BH-0.66-60W/600/0.5	34,60 €	F5	92	1
BH-0.66-60W/750/0.5	35,90 €	F5	92	1
BH-0.66-60W/800/0.5	36,10 €	F5	92	1
BH-0.66-80V/1000/0.5	32,00 €	F5	89	1
BH-0.66-80V/1200/0.5	35,30 €	F5	89	1
BH-0.66-80V/1500/0.5	37,40 €	F5	89	1
BH-0.66-80V/2000/0.5	39,70 €	F5	89	1
BH-0.66-80V/2500/0.5	45,90 €	F5	89	1
BH-0.66-80V/300/0.5	30,20 €	F5	89	1
BH-0.66-80V/400/0.5	30,20 €	F5	89	1
BH-0.66-80V/500/0.5	30,20 €	F5	89	1
BH-0.66-80V/600/0.5	30,20 €	F5	89	1
BH-0.66-80V/750/0.5	30,20 €	F5	89	1
BH-0.66-80V/800/0.5	30,20 €	F5	89	1
BH-0.66-80W/1000/0.5	38,60 €	F5	90	1
BH-0.66-80W/1200/0.5	38,60 €	F5	90	1
BH-0.66-80W/1500/0.5	43,10 €	F5	90	1
BH-0.66-80W/2000/0.5	46,40 €	F5	90	1
BH-0.66-80W/2500/0.5	52,30 €	F5	90	1
BH-0.66-80W/600/0.5	34,10 €	F5	90	1
BH-0.66-80W/750/0.5	34,10 €	F5	90	1
BH-0.66-80W/800/0.5	34,10 €	F5	90	1
BH-0.66-80W/1000/0.5	38,60 €	F5	92	1
BH-0.66-80W/1200/0.5	38,60 €	F5	92	1
BH-0.66-80W/1500/0.5	43,10 €	F5	92	1
BH-0.66-80W/2000/0.5	46,40 €	F5	92	1
BH-0.66-80W/2500/0.5	52,30 €	F5	92	1
BH-0.66-80W/3000/0.5	60,40 €	F5	92	1
BH-0.66-80W/500/0.5	34,10 €	F5	92	1

Referencia	P.V.P.	Fam.	Pag.	Emb.
BH-0.66-80W/600/0.5	34,10 €	F5	92	1
BH-0.66-80W/750/0.5	34,10 €	F5	92	1
BH-0.66-80W/800/0.5	34,10 €	F5	92	1
BMH-115	20,10 €	F2	53	1
BMH-185	22,90 €	F2	53	1
BMH-265	32,40 €	F2	53	1
BMH-40	11,60 €	F2	53	1
BMH-630	95,50 €	F2	53	1
BMH-80	11,60 €	F2	53	1
BMH-9	11,60 €	F2	53	1
BRT36/0	8,10 €	F2	80	3
BRT36/00	6,00 €	F2	80	3
BRT36/1	16,30 €	F2	80	3
BRT36/2	18,50 €	F2	80	3
BRT36/3	30,80 €	F2	80	3
BRT36/4	170,90 €	F2	80	3
BRT-NR2-25	21,30 €	F1	55	6
BRT-NR2-36	22,40 €	F1	55	6
BRT-NR2-93	25,50 €	F1	55	6
BRT-NRE8-25	21,30 €	F1	55	6
BRT-NRE8-40	22,40 €	F1	55	6
BZMJ 1,14-10-3	175,00 €	F4	84	1
BZMJ 1,14-15-3	218,00 €	F4	84	1
BZMJ-0,23-10-3	190,00 €	F4	83	1
BZMJ-0,23-12-3	235,00 €	F4	83	1
BZMJ-0,23-15-3	262,00 €	F4	83	1
BZMJ-0,23-20-3	345,00 €	F4	83	1
BZMJ-0,23-5-3	115,00 €	F4	83	1
BZMJ-0,23-6-3	137,00 €	F4	83	1
BZMJ-0,23-7.5-3	152,00 €	F4	83	1
BZMJ-0,4-10-3	121,00 €	F4	83	1
BZMJ-0,4-10-3YN	121,00 €	F4	84	1
BZMJ-0,4-12-3	133,00 €	F4	83	1
BZMJ-0,4-14-3	145,00 €	F4	83	1
BZMJ-0,4-15-3	152,00 €	F4	83	1
BZMJ-0,4-15-3YN	152,00 €	F4	84	1
BZMJ-0,4-16-3	158,00 €	F4	83	1
BZMJ-0,4-18-3	163,00 €	F4	83	1
BZMJ-0,4-20-3	170,00 €	F4	83	1
BZMJ-0,4-20-3YN	170,00 €	F4	84	1
BZMJ-0,4-25-3	186,00 €	F4	83	1
BZMJ-0,4-30-3	236,00 €	F4	83	1
BZMJ-0,4-3-3	89,00 €	F4	83	1
BZMJ-0,4-40-3	294,00 €	F4	83	1
BZMJ-0,4-50-3	319,00 €	F4	83	1
BZMJ-0,45-10-3	145,00 €	F4	84	1
BZMJ-0,45-12-3	160,00 €	F4	84	1
BZMJ-0,45-14-3	174,00 €	F4	84	1
BZMJ-0,45-15-3	182,00 €	F4	84	1
BZMJ-0,45-16-3	190,00 €	F4	84	1
BZMJ-0,45-18-3	196,00 €	F4	84	1
BZMJ-0,45-20-3	204,00 €	F4	84	1
BZMJ-0,45-25-3	223,00 €	F4	84	1
BZMJ-0,4-5-3	93,00 €	F4	83	1
BZMJ-0,45-30-3	283,00 €	F4	84	1
BZMJ-0,45-3-3	107,00 €	F4	84	1
BZMJ-0,45-40-3	353,00 €	F4	84	1
BZMJ-0,45-50-3	383,00 €	F4	84	1
BZMJ-0,45-5-3	112,00 €	F4	84	1
BZMJ-0,45-60-3	450,00 €	F4	84	1
BZMJ-0,45-6-3	117,00 €	F4	84	1
BZMJ-0,45-7.5-3	120,00 €	F4	84	1
BZMJ-0,45-8-3	134,00 €	F4	84	1
BZMJ-0,4-60-3	375,00 €	F4	83	1
BZMJ-0,4-6-3	97,00 €	F4	83	1
BZMJ-0,4-7.5-3	100,00 €	F4	83	1
BZMJ-0,4-7.5-3YN	100,00 €	F4	84	1
BZMJ-0,4-8-3	112,00 €	F4	83	1
BZMJ-0,525-10-3	145,00 €	F4	84	1
BZMJ-0,525-15-3	182,00 €	F4	84	1

Referencia	P.V.P.	Fam.	Pag.	Emb.
BZMJ-0,525-20-3	204,00 €	F4	84	1
BZMJ-0,525-25-3	223,00 €	F4	84	1
BZMJ-0,525-30-3	283,00 €	F4	84	1
BZMJ-0,525-40-3	353,00 €	F4	84	1
BZMJ-0,525-50-3	383,00 €	F4	84	1
BZMJ-0,525-5-3	107,00 €	F4	84	1
BZMJ-0,525-60-3	450,00 €	F4	84	1
BZMJ-0,69-10-3	151,00 €	F4	84	1
BZMJ-0,69-15-3	193,00 €	F4	84	1
BZMJ-0,69-20-3	206,00 €	F4	84	1
BZMJ-0,69-25-3	228,00 €	F4	84	1
BZMJ-0,69-30-3	292,00 €	F4	84	1
BZMJ-0,69-40-3	368,00 €	F4	84	1
BZMJ-0,69-50-3	396,00 €	F4	84	1
BZMJ-0,69-5-3	118,00 €	F4	84	1
BZMJ-0,69-60-3	471,00 €	F4	84	1
CAN	8,60 €	F5	124	1
CJ19-3-25-02-110	63,40 €	F2	51	1
CJ19-3-25-02-230	63,40 €	F2	51	1
CJ19-3-25-02-24	63,40 €	F2	51	1
CJ19-3-25-02-400	63,40 €	F2	51	1
CJ19-3-25-02-48	63,40 €	F2	51	1
CJ19-3-25-11-110	63,40 €	F2	51	1
CJ19-3-25-11-230	63,40 €	F2	51	1
CJ19-3-25-11-24	63,40 €	F2	51	1
CJ19-3-25-11-400	63,40 €	F2	51	1
CJ19-3-25-11-48	63,40 €	F2	51	1
CJ19-3-25-20-110	63,40 €	F2	51	1
CJ19-3-25-20-230	63,40 €	F2	51	1
CJ19-3-25-20-24	63,40 €	F2	51	1
CJ19-3-25-20-400	63,40 €	F2	51	1
CJ19-3-25-20-48	63,40 €	F2	51	1
CJ19-3-31-11-110	84,40 €	F2	51	1
CJ19-3-31-11-230	84,40 €	F2	51	1
CJ19-3-31-11-24	84,40 €	F2	51	1
CJ19-3-31-11-400	84,40 €	F2	51	1
CJ19-3-31-11-48	84,40 €	F2	51	1
CJ19-3-32-02-110	84,40 €	F2	51	1
CJ19-3-32-02-230	84,40 €	F2	51	1
CJ19-3-32-02-24	84,40 €	F2	51	1
CJ19-3-32-02-400	84,40 €	F2	51	1
CJ19-3-32-02-48	84,40 €	F2	51	1
CJ19-3-32-20-110	84,40 €	F2	51	1
CJ19-3-32-20-230	84,40 €	F2	51	1
CJ19-3-32-20-24	84,40 €	F2	51	1
CJ19-3-32-20-400	84,40 €	F2	51	1
CJ19-3-32-20-48	84,40 €	F2	51	1
CJ19-3-43-02-110	94,50 €	F2	51	1
CJ19-3-43-02-230	94,50 €	F2	51	1
CJ19-3-43-02-24	94,50 €	F2	51	1
CJ19-3-43-02-400	94,50 €	F2	51	1
CJ19-3-43-02-48	94,50 €	F2	51	1
CJ19-3-43-11-110	94,50 €	F2	51	1
CJ19-3-43-11-230	94,50 €	F2	51	1
CJ19-3-43-11-24	94,50 €	F2	51	1
CJ19-3-43-11-400	94,50 €	F2	51	1
CJ19-3-43-11-48	94,50 €	F2	51	1
CJ19-3-43-20-110	94,50 €	F2	51	1
CJ19-3-43-20-230	94,50 €	F2	51	1
CJ19-3-43-20-24	94,50 €	F2	51	1
CJ19-3-43-20-400	94,50 €	F2	51	1
CJ19-3-43-20-48	94,50 €	F2	51	1
CJ19-3-63-12-110	123,20 €	F2	51	1
CJ19-3-63-12-230	123,20 €	F2	51	1
CJ19-3-63-12-24	123,20 €	F2	51	1
CJ19-3-63-12-400	123,20 €	F2	51	1
CJ19-3-63-12-48	123,20 €	F2	51	1
CJ19-3-63-21-110	123,20 €	F2	51	1
CJ19-3-63-21-230	123,20 €	F2	51	1
CJ19-3-63-21-24	123,20 €	F2	51	1

Referencia	P.V.P.	Fam.	Pag.	Emb.
CJ19-3-63-21-400	123,20 €	F2	51	1
CJ19-3-63-21-48	123,20 €	F2	51	1
CJ19-3-95-12-110	166,30 €	F2	51	1
CJ19-3-95-12-230	166,30 €	F2	51	1
CJ19-3-95-12-24	166,30 €	F2	51	1
CJ19-3-95-12-400	166,30 €	F2	51	1
CJ19-3-95-12-48	166,30 €	F2	51	1
CJ19-3-95-21-110	166,30 €	F2	51	1
CJ19-3-95-21-230	166,30 €	F2	51	1
CJ19-3-95-21-24	166,30 €	F2	51	1
CJ19-3-95-21-400	166,30 €	F2	51	1
CJ19-3-95-21-48	166,30 €	F2	51	1
CM/BFA-20/67	68,00 €	F5	122	1
CM/BFA-20/890	81,40 €	F5	122	1
CM/BFA-30/67	70,40 €	F5	122	1
CM/BFA-30/890	84,00 €	F5	122	1
CM/BFA-45/67	72,20 €	F5	122	1
CM/BFA-45/890	85,30 €	F5	122	1
CM/BFAB-104	164,20 €	F5	124	1
CM/BFAB-105	167,50 €	F5	124	1
CM/BFAB-106	170,80 €	F5	124	1
CM/BFAB-107	174,20 €	F5	124	1
CM/BFAB-108	177,70 €	F5	124	1
CM/BFAB-64	120,70 €	F5	124	1
CM/BFAB-65	123,10 €	F5	124	1
CM/BFAB-66	125,60 €	F5	124	1
CM/BFAB-67	128,10 €	F5	124	1
CM/BFAB-68	130,70 €	F5	124	1
CM/BFAB-74	130,40 €	F5	124	1
CM/BFAB-75	132,90 €	F5	124	1
CM/BFAB-76	135,60 €	F5	124	1
CM/BFAB-77	138,30 €	F5	124	1
CM/BFAB-78	141,10 €	F5	124	1
CM/BFAB-84	140,80 €	F5	124	1
CM/BFAB-85	143,60 €	F5	124	1
CM/BFAB-86	146,40 €	F5	124	1
CM/BFAB-87	149,40 €	F5	124	1
CM/BFAB-88	152,40 €	F5	124	1
CM/BFAB-94	152,10 €	F5	124	1
CM/BFAB-95	155,10 €	F5	124	1
CM/BFAB-96	158,20 €	F5	124	1
CM/BFAB-97	161,30 €	F5	124	1
CM/BFAB-98	164,60 €	F5	124	1
CM/BZ	57,00 €	F5	124	1
CM/CH-11	400,80 €	F5	123	1
CM/CH-18	346,70 €	F5	123	1
CM/CH-21	463,60 €	F5	123	1
CM/CH-26	343,50 €	F5	123	1
CM/CH-27	370,10 €	F5	123	1
CM/CH-28	396,70 €	F5	123	1
CM/CH-29	426,10 €	F5	123	1
CM/CHP-11	595,20 €	F5	123	1
CM/CHP-18	532,80 €	F5	123	1
CM/CHP-21	630,90 €	F5	123	1
CM/CHP-26	486,70 €	F5	123	1
CM/CHP-27	517,10 €	F5	123	1
CM/CHP-28	554,50 €	F5	123	1
CM/CHP-29	588,60 €	F5	123	1
CMLT-14	187,00 €	F5	123	1
CMLT-16	213,40 €	F5	123	1
CMLT-24	199,00 €	F5	123	1
CMLT-25	236,60 €	F5	123	1
CMLT-26	261,20 €	F5	123	1
CMLT-27	284,90 €	F5	123	1
CMLT-28	308,70 €	F5	123	1
CM/PI-11	371,00 €	F5	122	1
CM/PI-18	333,00 €	F5	122	1
CM/PI-21	380,80 €	F5	122	1
CM/PI-26	321,00 €	F5	122	1
CM/PI-27	332,10 €	F5	122	1

Referencia	P.V.P.	Fam.	Pag.	Emb.
CM/PI-28	342,30 €	F5	122	1
CM/PI-29	361,60 €	F5	122	1
CM/PL-11	245,10 €	F5	123	1
CM/PL-18	206,90 €	F5	123	1
CM/PL-21	258,60 €	F5	123	1
CM/PL-26	189,60 €	F5	123	1
CM/PL-27	207,60 €	F5	123	1
CM/PL-28	225,60 €	F5	123	1
CM/PL-29	253,10 €	F5	123	1
CM/PMP-30/100	89,60 €	F5	122	1
CM/PMP-30/60	79,50 €	F5	122	1
CM/PMP-30/70	81,90 €	F5	122	1
CM/PMP-30/80	85,00 €	F5	122	1
CM/PMP-30/90	87,30 €	F5	122	1
CM/PMP-45/100	101,30 €	F5	122	1
CM/PMP-45/60	87,00 €	F5	122	1
CM/PMP-45/70	90,70 €	F5	122	1
CM/PMP-45/80	103,10 €	F5	122	1
CM/PMP-45/90	97,00 €	F5	122	1
CM/PMP-60/100	117,80 €	F5	122	1
CM/PMP-60/60	96,70 €	F5	122	1
CM/PMP-60/70	101,80 €	F5	122	1
CM/PMP-60/80	106,10 €	F5	122	1
CM/PMP-60/90	109,40 €	F5	122	1
CM/TEC-104	59,20 €	F5	124	1
CM/TEC-105	66,70 €	F5	124	1
CM/TEC-106	72,30 €	F5	124	1
CM/TEC-107	81,10 €	F5	124	1
CM/TEC-108	89,80 €	F5	124	1
CM/TEC-64	45,20 €	F5	124	1
CM/TEC-65	52,50 €	F5	124	1
CM/TEC-66	53,50 €	F5	124	1
CM/TEC-67	61,00 €	F5	124	1
CM/TEC-67	68,50 €	F5	124	1
CM/TEC-74	48,80 €	F5	124	1
CM/TEC-75	53,50 €	F5	124	1
CM/TEC-76	58,70 €	F5	124	1
CM/TEC-77	65,40 €	F5	124	1
CM/TEC-78	72,00 €	F5	124	1
CM/TEC-84	52,50 €	F5	124	1
CM/TEC-85	54,60 €	F5	124	1
CM/TEC-86	63,90 €	F5	124	1
CM/TEC-87	69,70 €	F5	124	1
CM/TEC-88	75,60 €	F5	124	1
CM/TEC-94	55,80 €	F5	124	1
CM/TEC-95	60,60 €	F5	124	1
CM/TEC-96	68,10 €	F5	124	1
CM/TEC-97	75,40 €	F5	124	1
CM/TEC-98	82,70 €	F5	124	1
CM/ZOC-104/100	115,40 €	F5	123	1
CM/ZOC-104/200	229,60 €	F5	123	1
CM/ZOC-105/100	118,40 €	F5	123	1
CM/ZOC-105/200	232,60 €	F5	123	1
CM/ZOC-106/100	120,10 €	F5	123	1
CM/ZOC-106/200	246,90 €	F5	123	1
CM/ZOC-107/100	123,90 €	F5	123	1
CM/ZOC-107/200	257,20 €	F5	123	1
CM/ZOC-108/100	127,80 €	F5	123	1
CM/ZOC-108/200	270,90 €	F5	123	1
CM/ZOC-64/100	95,60 €	F5	123	1
CM/ZOC-64/200	173,60 €	F5	123	1
CM/ZOC-65/100	97,70 €	F5	123	1
CM/ZOC-65/200	173,80 €	F5	123	1
CM/ZOC-66/100	104,90 €	F5	123	1
CM/ZOC-66/200	196,40 €	F5	123	1
CM/ZOC-67/100	106,90 €	F5	123	1
CM/ZOC-67/200	200,80 €	F5	123	1
CM/ZOC-67/200	214,60 €	F5	123	1
CM/ZOC-68/100	108,90 €	F5	123	1
CM/ZOC-74/100	96,90 €	F5	123	1

Referencia	P.V.P.	Fam.	Pag.	Emb.
CM/ZOC-74/200	185,40 €	F5	123	1
CM/ZOC-75/100	100,90 €	F5	123	1
CM/ZOC-75/200	193,00 €	F5	123	1
CM/ZOC-76/100	106,30 €	F5	123	1
CM/ZOC-76/200	203,50 €	F5	123	1
CM/ZOC-77/100	111,80 €	F5	123	1
CM/ZOC-77/200	214,10 €	F5	123	1
CM/ZOC-78/100	117,30 €	F5	123	1
CM/ZOC-78/200	224,50 €	F5	123	1
CM/ZOC-84/100	101,10 €	F5	123	1
CM/ZOC-84/200	192,80 €	F5	123	1
CM/ZOC-85/100	104,20 €	F5	123	1
CM/ZOC-85/200	203,40 €	F5	123	1
CM/ZOC-86/100	107,90 €	F5	123	1
CM/ZOC-86/200	212,40 €	F5	123	1
CM/ZOC-87/100	116,80 €	F5	123	1
CM/ZOC-87/200	223,50 €	F5	123	1
CM/ZOC-88/100	125,80 €	F5	123	1
CM/ZOC-88/200	234,60 €	F5	123	1
CM/ZOC-94/100	107,00 €	F5	123	1
CM/ZOC-94/200	209,20 €	F5	123	1
CM/ZOC-95/100	111,30 €	F5	123	1
CM/ZOC-95/200	217,50 €	F5	123	1
CM/ZOC-96/100	116,80 €	F5	123	1
CM/ZOC-96/200	228,30 €	F5	123	1
CM/ZOC-97/100	121,80 €	F5	123	1
CM/ZOC-97/200	238,00 €	F5	123	1
CM/ZOC-98/100	126,80 €	F5	123	1
CM/ZOC-98/200	251,00 €	F5	123	1
CM-114-PN	1.186,00 €	F5	120	1
CM-114-PT	1.437,10 €	F5	121	1
CM-116-PN	1.241,10 €	F5	120	1
CM-116-PT	1.466,20 €	F5	121	1
CM-184-PN	1.001,80 €	F5	120	1
CM-184-PT	1.214,00 €	F5	121	1
CM-186-PN	1.069,40 €	F5	120	1
CM-186-PT	1.269,20 €	F5	121	1
CM-214-PN	1.174,90 €	F5	120	1
CM-214-PT	1.429,20 €	F5	121	1
CM-215-PN	1.192,70 €	F5	120	1
CM-215-PT	1.470,80 €	F5	121	1
CM-216-PN	1.207,40 €	F5	120	1
CM-216-PT	1.497,60 €	F5	121	1
CM-217-PN	1.227,00 €	F5	120	1
CM-217-PT	1.506,90 €	F5	121	1
CM-218-PN	1.246,60 €	F5	120	1
CM-218-PT	1.516,10 €	F5	121	1
CM-264-PN	1.007,70 €	F5	120	1
CM-264-PT	1.202,80 €	F5	121	1
CM-265-PN	1.026,30 €	F5	120	1
CM-265-PT	1.201,10 €	F5	121	1
CM-266-PN	1.044,80 €	F5	120	1
CM-266-PT	1.235,10 €	F5	121	1
CM-267-PN	1.062,90 €	F5	120	1
CM-267-PT	1.266,40 €	F5	121	1
CM-268-PN	1.096,50 €	F5	120	1
CM-268-PT	1.297,80 €	F5	121	1
CM-274-PN	1.037,90 €	F5	120	1
CM-274-PT	1.252,80 €	F5	121	1
CM-275-PN	1.056,00 €	F5	120	1
CM-275-PT	1.273,90 €	F5	121	1
CM-276-PN	1.075,20 €	F5	120	1
CM-276-PT	1.295,00 €	F5	121	1
CM-277-PN	1.094,50 €	F5	120	1
CM-277-PT	1.319,50 €	F5	121	1
CM-278-PN	1.113,80 €	F5	120	1
CM-278-PT	1.346,60 €	F5	121	1
CM-284-PN	1.052,40 €	F5	120	1
CM-284-PT	1.302,80 €	F5	121	1
CM-285-PN	1.057,60 €	F5	120	1

Referencia	P.V.P.	Fam.	Pag.	Emb.
CM-285-PT	1.305,40 €	F5	121	1
CM-286-PN	1.079,50 €	F5	120	1
CM-286-PT	1.328,00 €	F5	121	1
CM-287-PN	1.105,30 €	F5	120	1
CM-287-PT	1.361,70 €	F5	121	1
CM-288-PN	1.131,00 €	F5	120	1
CM-288-PT	1.395,50 €	F5	121	1
CM-294-PN	1.102,50 €	F5	120	1
CM-294-PT	1.360,70 €	F5	121	1
CM-295-PN	1.124,10 €	F5	120	1
CM-295-PT	1.384,50 €	F5	121	1
CM-296-PN	1.145,60 €	F5	120	1
CM-296-PT	1.408,20 €	F5	121	1
CM-297-PN	1.167,20 €	F5	120	1
CM-297-PT	1.432,00 €	F5	121	1
CM-298-PN	1.188,80 €	F5	120	1
CM-298-PT	1.455,80 €	F5	121	1
CM/BFA-20/67	68,00 €	F5	117	1
CM/BFA-20/890	81,40 €	F5	117	1
CM/BFA-30/67	70,40 €	F5	117	1
CM/BFA-30/890	84,10 €	F5	117	1
CM/BFA-45/67	72,20 €	F5	117	1
CM/BFA-45/890	85,30 €	F5	117	1
CM/CH-121	259,80 €	F5	116	1
CM/CH-128	229,90 €	F5	116	1
CM/CH-141	314,20 €	F5	116	1
CM/CH-148	278,00 €	F5	116	1
CM/CH-161	350,60 €	F5	116	1
CM/CH-168	310,30 €	F5	116	1
CM/CH-181	391,80 €	F5	116	1
CM/CH-188	346,70 €	F5	116	1
CM/CH-201	448,30 €	F5	116	1
CM/CH-208	396,70 €	F5	116	1
CM/PI-121	285,40 €	F5	117	1
CM/PI-128	248,60 €	F5	118	1
CM/PI-141	315,20 €	F5	117	1
CM/PI-148	272,30 €	F5	117	1
CM/PI-161	345,00 €	F5	117	1
CM/PI-168	295,90 €	F5	117	1
CM/PI-181	374,70 €	F5	117	1
CM/PI-188	319,50 €	F5	117	1
CM/PI-201	404,60 €	F5	117	1
CM/PI-208	354,30 €	F5	117	1
CM/PL-121	200,70 €	F5	116	1
CM/PL-128	190,80 €	F5	116	1
CM/PL-141	227,40 €	F5	116	1
CM/PL-148	195,70 €	F5	116	1
CM/PL-161	243,00 €	F5	116	1
CM/PL-162	321,00 €	F5	116	1
CM/PL-168	198,70 €	F5	116	1
CM/PL-181	237,30 €	F5	116	1
CM/PL-182	274,70 €	F5	116	1
CM/PL-188	200,40 €	F5	116	1
CM/PL-201	271,70 €	F5	116	1
CM/PL-202	297,80 €	F5	116	1
CM/PL-208	218,50 €	F5	116	1
CM/PMD-10/300	50,70 €	F5	117	1
CM/PMD-10/450	54,80 €	F5	117	1
CM/PMD-10/600	59,20 €	F5	117	1
CM/PMD-12/300	56,80 €	F5	117	1
CM/PMD-12/450	61,30 €	F5	117	1
CM/PMD-12/600	66,20 €	F5	117	1
CM/PMD-8/300	45,30 €	F5	117	1
CM/PMD-8/450	48,90 €	F5	117	1
CM/PMD-8/600	52,80 €	F5	117	1
CM/PMP-30/100	89,70 €	F5	117	1
CM/PMP-30/120	95,40 €	F5	117	1
CM/PMP-30/80	85,00 €	F5	117	1
CM/PMP-45/100	101,30 €	F5	117	1
CM/PMP-45/120	107,70 €	F5	117	1

Referencia	P.V.P.	Fam.	Pag.	Emb.
CM/PMP-45/80	103,10 €	F5	117	1
CM/TJ-103	124,30 €	F5	118	1
CM/TJ-104	141,90 €	F5	118	1
CM/TJ-123	135,00 €	F5	118	1
CM/TJ-124	155,00 €	F5	118	1
CM/TJ-83	108,40 €	F5	118	1
CM/TJ-84	121,80 €	F5	118	1
CM/ZOC-103/100	108,00 €	F5	118	1
CM/ZOC-103/200	201,90 €	F5	118	1
CM/ZOC-104/100	109,40 €	F5	118	1
CM/ZOC-104/200	217,50 €	F5	118	1
CM/ZOC-123/100	116,40 €	F5	118	1
CM/ZOC-123/200	219,60 €	F5	118	1
CM/ZOC-124/100	120,60 €	F5	118	1
CM/ZOC-124/200	231,80 €	F5	118	1
CM/ZOC-83/100	95,10 €	F5	118	1
CM/ZOC-83/200	174,90 €	F5	118	1
CM/ZOC-84/100	95,80 €	F5	118	1
CM/ZOC-84/200	182,70 €	F5	118	1
CMI-014-PN	1.193,60 €	F5	115	1
CMI-014-PN/PM	1.379,20 €	F5	115	1
CMI-014-PT	1.635,00 €	F5	116	1
CMI-024-PN	1.294,60 €	F5	115	1
CMI-024-PN/PM	1.544,60 €	F5	115	1
CMI-084-PN	1.047,00 €	F5	115	1
CMI-084-PN/PM	1.215,10 €	F5	115	1
CMI-084-PT	1.390,20 €	F5	116	1
CMI-213-PN	704,90 €	F5	115	1
CMI-213-PN/PM	839,40 €	F5	115	1
CMI-213-PT	943,80 €	F5	116	1
CMI-214-PN	730,50 €	F5	115	1
CMI-214-PN/PM	868,40 €	F5	115	1
CMI-214-PT	973,00 €	F5	116	1
CMI-283-PN	582,80 €	F5	115	1
CMI-283-PN/PM	664,20 €	F5	115	1
CMI-283-PT	783,40 €	F5	116	1
CMI-284-PN	604,00 €	F5	115	1
CMI-284-PN/PM	688,30 €	F5	115	1
CMI-284-PT	807,60 €	F5	116	1
CMI-413-PN	851,80 €	F5	115	1
CMI-413-PN/PM	1.047,80 €	F5	115	1
CMI-413-PT	1.012,20 €	F5	116	1
CMI-414-PN	882,70 €	F5	115	1
CMI-414-PN/PM	1.085,80 €	F5	115	1
CMI-414-PT	1.104,20 €	F5	116	1
CMI-483-PN	650,00 €	F5	115	1
CMI-483-PN/PM	826,10 €	F5	115	1
CMI-483-PT	860,40 €	F5	116	1
CMI-484-PN	664,60 €	F5	115	1
CMI-484-PN/PM	835,20 €	F5	115	1
CMI-484-PT	938,60 €	F5	116	1
CMI-613-PN	861,20 €	F5	115	1
CMI-613-PN/PM	1.027,90 €	F5	115	1
CMI-613-PT	1.182,60 €	F5	116	1
CMI-614-PN	938,50 €	F5	115	1
CMI-614-PN/PM	1.100,70 €	F5	115	1
CMI-614-PT	1.169,80 €	F5	116	1
CMI-623-PN	970,00 €	F5	115	1
CMI-623-PN/PM	1.252,80 €	F5	115	1
CMI-624-PN	1.099,20 €	F5	115	1
CMI-624-PN/PM	1.365,80 €	F5	115	1
CMI-683-PN	698,30 €	F5	115	1
CMI-683-PN/PM	813,30 €	F5	115	1
CMI-683-PT	959,30 €	F5	116	1
CMI-684-PN	767,40 €	F5	115	1
CMI-684-PN/PM	935,00 €	F5	115	1
CMI-684-PT	994,30 €	F5	116	1
CMI-814-PN	1.054,70 €	F5	115	1
CMI-814-PN/PM	1.265,20 €	F5	115	1
CMI-814-PT	1.346,80 €	F5	116	1

Referencia	P.V.P.	Fam.	Pag.	Emb.
CMI-824- PN	1.216,00 €	F5	115	1
CMI-824- PN/PM	1.477,00 €	F5	115	1
CMI-883- PN	792,10 €	F5	115	1
CMI-883- PN/PM	879,70 €	F5	115	1
CMI-883- PT	1.061,30 €	F5	116	1
CMI-884- PN	837,10 €	F5	115	1
CMI-884- PN/PM	985,10 €	F5	115	1
CMI-884- PT	1.144,80 €	F5	116	1
CZF08A- 01E	7,10 €	F3	81	10
CZF08A- E	7,10 €	F3	81	10
CZF11A- E	8,50 €	F3	81	10
CZY08B- 01E	6,50 €	F3	82	10
CZY11B- 01E	7,30 €	F3	82	10
CZY14B- 01E	8,10 €	F3	82	10
DDS666- 10/40	65,00 €	F5	99	1
DDS666- 10/60	68,40 €	F5	99	1
DDS666- 15/100	75,70 €	F5	99	1
DDS666- 20/80	73,60 €	F5	99	1
DDS666- 30/100	78,90 €	F5	99	1
DDS666- 5/20	61,50 €	F5	99	1
DDS666- 5/30	62,40 €	F5	99	1
DDS666- 5/60	64,20 €	F5	99	1
DDSY666- 1,5/6	395,00 €	F5	99	1
DDSY666- 10/40	395,00 €	F5	99	1
DDSY666- 2,5/10	395,00 €	F5	99	1
DDSY666- 5/20	395,00 €	F5	99	1
DDSY666- 5/30	395,00 €	F5	99	1
DIN/1- PN	160,80 €	F5	105	1
DIN/1- PT	201,00 €	F5	105	1
DIN/2- PN	176,10 €	F5	105	1
DIN/2- PN+ICP	232,10 €	F5	105	1
DIN/2- PT	222,10 €	F5	105	1
DIN/2- PT+ICP	292,50 €	F5	105	1
DIN/32	82,65 €	F5	108	1
DIN/3- PN	214,20 €	F5	105	1
DIN/3- PN+ICP	282,20 €	F5	105	1
DIN/3- PT	289,10 €	F5	105	1
DIN/3- PT+ICP	380,70 €	F5	105	1
DIN/48	101,10 €	F5	108	1
DIN/4- PN	250,80 €	F5	105	1
DIN/4- PN+ICP	331,50 €	F5	105	1
DIN/4- PT	338,50 €	F5	105	1
DIN/4- PT+ICP	445,90 €	F5	105	1
DIN/5- PN	287,30 €	F5	105	1
DIN/5- PN+ICP	378,50 €	F5	105	1
DIN/5- PT	387,90 €	F5	105	1
DIN/5- PT+ICP	511,00 €	F5	105	1
DIN/64	110,20 €	F5	108	1
DIN/6- PN	329,10 €	F5	105	1
DIN/6- PN+ICP	433,50 €	F5	105	1
DIN/6- PT	444,20 €	F5	105	1
DIN/6- PT+ICP	585,10 €	F5	105	1
DIN/7- PN	387,10 €	F5	105	1
DIN/7- PN+ICP	509,90 €	F5	105	1
DIN/7- PT	522,60 €	F5	105	1
DIN/7- PT+ICP	688,70 €	F5	105	1
DIN/8- PN	441,30 €	F5	105	1
DIN/8- PN+ICP	581,30 €	F5	105	1
DIN/8- PT	601,00 €	F5	105	1
DIN/8- PT+ICP	791,70 €	F5	105	1
DIN/ICP- 24	88,70 €	F5	108	1
DIN/ICP- 32	110,50 €	F5	108	1
DIN/ICP- 48	119,30 €	F5	108	1
DINS/1- PN	185,00 €	F5	106	1
DINS/1- PT	205,10 €	F5	106	1
DINS/2- PN	201,90 €	F5	106	1
DINS/2- PN+ICP	265,90 €	F5	106	1
DINS/2- PT	237,50 €	F5	106	1
DINS/2- PT+ICP	312,90 €	F5	106	1
DINS/3- PN	232,80 €	F5	106	1

Referencia	P.V.P.	Fam.	Pag.	Emb.
DINS/3- PN+ICP	306,70 €	F5	106	1
DINS/3- PT	300,00 €	F5	106	1
DINS/3- PT+ICP	395,20 €	F5	106	1
DINS/4- PN	303,40 €	F5	106	1
DINS/4- PN+ICP	399,60 €	F5	106	1
DINS/4- PT	364,90 €	F5	106	1
DINS/4- PT+ICP	480,70 €	F5	106	1
DINS/5- PN	338,30 €	F5	106	1
DINS/5- PN+ICP	445,70 €	F5	106	1
DINS/5- PT	402,40 €	F5	106	1
DINS/5- PT+ICP	530,00 €	F5	106	1
DINS/6- PN	358,20 €	F5	106	1
DINS/6- PN+ICP	470,00 €	F5	106	1
DINS/6- PT	482,80 €	F5	106	1
DINS/6- PT+ICP	636,10 €	F5	106	1
DINS/7- PN	421,40 €	F5	106	1
DINS/7- PN+ICP	555,10 €	F5	106	1
DINS/7- PT	568,00 €	F5	106	1
DINS/7- PT+ICP	748,30 €	F5	106	1
DINS/8- PN	484,60 €	F5	106	1
DINS/8- PN+ICP	638,60 €	F5	106	1
DINS/8- PT	653,30 €	F5	106	1
DINS/8- PT+ICP	860,60 €	F5	106	1
DZ158- 1- 100	57,40 €	F2	10	12/108
DZ158- 1- 125	65,60 €	F2	10	12/108
DZ158- 1- 63	39,90 €	F2	10	12/108
DZ158- 1- 80	50,00 €	F2	10	12/108
DZ158- 2- 100	97,70 €	F2	10	6/54
DZ158- 2- 125	122,80 €	F2	10	6/54
DZ158- 2- 63	77,70 €	F2	10	6/54
DZ158- 2- 80	94,20 €	F2	10	6/54
DZ158- 3- 100	130,80 €	F2	10	4/36
DZ158- 3- 125	164,10 €	F2	10	4/36
DZ158- 3- 63	98,30 €	F2	10	4/36
DZ158- 3- 80	109,30 €	F2	10	4/36
DZ158- 4- 100	172,90 €	F2	10	3/27
DZ158- 4- 125	239,40 €	F2	10	3/27
DZ158- 4- 63	124,90 €	F2	10	3/27
DZ158- 4- 80	162,20 €	F2	10	3/27
DZ158LE- 2- 100C300AC	175,40 €	F3	19	1/36
DZ158LE- 2- 100C30AC	182,10 €	F3	19	1/36
DZ158LE- 2- 63C300AC	132,80 €	F3	19	1/36
DZ158LE- 2- 63C30AC	135,70 €	F3	19	1/36
DZ158LE- 2- 80C300AC	145,20 €	F3	19	1/36
DZ158LE- 2- 80C30AC	149,80 €	F3	19	1/36
DZ158LE- 3- 100C300AC	192,90 €	F3	19	1/27
DZ158LE- 3- 100C30AC	198,80 €	F3	19	1/27
DZ158LE- 3- 63C300AC	138,80 €	F3	19	1/27
DZ158LE- 3- 63C30AC	143,10 €	F3	19	1/27
DZ158LE- 3- 80C300AC	184,90 €	F3	19	1/27
DZ158LE- 3- 80C30AC	168,80 €	F3	19	1/27
DZ158LE- 4- 100C300AC	253,20 €	F3	19	1/18
DZ158LE- 4- 100C30AC	260,20 €	F3	19	1/18
DZ158LE- 4- 63C300AC	214,60 €	F3	19	1/18
DZ158LE- 4- 63C30AC	221,20 €	F3	19	1/18
DZ158LE- 4- 80C300AC	230,00 €	F3	19	1/18
DZ158LE- 4- 80C30AC	234,60 €	F3	19	1/18
DZ267- 1N- 10C	10,02 €	F1	1	12/120
DZ267- 1N- 16C	10,02 €	F1	1	12/120
DZ267- 1N- 20C	10,02 €	F1	1	12/120
DZ267- 1N- 25C	10,02 €	F1	1	12/120
DZ267- 1N- 32C	10,02 €	F1	1	12/120
DZ267- 1N- 6C	10,02 €	F1	1	12/120
eB- 2- 10C	7,70 €	F1	1	6/72
eB- 2- 16C	7,70 €	F1	1	6/72
eB- 2- 20C	7,70 €	F1	1	6/72
eB- 2- 25C	7,70 €	F1	1	6/72
eB- 2- 32C	8,50 €	F1	1	6/72
eB- 2- 40C	8,60 €	F1	1	6/72
eB- 2- 6C	7,70 €	F1	1	6/72

Referencia	P.V.P.	Fam.	Pag.	Emb.
ERT36	17,50 €	F2	80	1
F4-02	6,50 €	F2	52	6
F4-04	8,60 €	F2	52	6
F4-11	6,50 €	F2	52	6
F4-13	8,60 €	F2	52	6
F4-20	6,50 €	F2	52	6
F4-22	8,60 €	F2	52	6
F4-31	8,60 €	F2	52	6
F4-40	8,60 €	F2	52	6
F5-D0	33,50 €	F2	52	6
F5-D2	33,50 €	F2	52	6
F5-D4	40,20 €	F2	52	6
F5-T0	33,50 €	F2	52	6
F5-T2	33,50 €	F2	52	6
F5-T4	40,20 €	F2	52	6
F6-02	6,50 €	F2	52	6
F6-04	8,60 €	F2	52	6
F6-11	6,50 €	F2	52	6
F6-13	8,60 €	F2	52	6
F6-20	6,50 €	F2	52	6
F6-22	8,60 €	F2	52	6
F6-31	8,60 €	F2	52	6
F6-40	8,60 €	F2	52	6
FF	8,20 €	F2	53	1
FG	9,40 €	F2	53	1
FH	15,50 €	F2	53	1
FK	15,50 €	F2	53	1
FL	18,30 €	F2	53	1
GG	9,00 €	F2	53	1
GH	14,70 €	F2	53	1
GK	14,70 €	F2	53	1
GL	17,40 €	F2	53	1
GUIADIN35	6,30 €	F1	28	1
HH	19,50 €	F2	53	1
HK	14,70 €	F2	53	1
HL	17,40 €	F2	53	1
JBK5-1000-110-48/24	111,80 €	F3	86	1
JBK5-1000-110-48/48	111,80 €	F3	86	1
JBK5-1000-110-48/48-24	116,80 €	F3	86	1
JBK5-1000-230/110	107,80 €	F3	86	1
JBK5-1000-230-110-24	111,80 €	F3	86	1
JBK5-1000-230/110-48	111,80 €	F3	86	1
JBK5-1000-230/12	107,80 €	F3	86	1
JBK5-1000-230/127	107,80 €	F3	86	1
JBK5-1000-230/230	107,80 €	F3	86	1
JBK5-1000-230/24	107,80 €	F3	86	1
JBK5-1000-230/36	107,80 €	F3	86	1
JBK5-1000-230/400	107,80 €	F3	86	1
JBK5-1000-230/48-24	111,80 €	F3	86	1
JBK5-1000-230/6	107,80 €	F3	86	1
JBK5-1000-230-110/110	111,80 €	F3	86	1
JBK5-1000-230-110/110-24	116,80 €	F3	86	1
JBK5-1000-230-110/110-48	116,80 €	F3	86	1
JBK5-1000-230-110/24	111,80 €	F3	86	1
JBK5-1000-230-110/48	111,80 €	F3	86	1
JBK5-1000-400/110	107,80 €	F3	86	1
JBK5-1000-400-110-24	111,80 €	F3	86	1
JBK5-1000-400/110-48	111,80 €	F3	86	1
JBK5-1000-400/12	107,80 €	F3	86	1
JBK5-1000-400/127	107,80 €	F3	86	1
JBK5-1000-400/230	107,80 €	F3	86	1
JBK5-1000-400/230-110	111,80 €	F3	86	1
JBK5-1000-400/230-24	111,80 €	F3	86	1
JBK5-1000-400/230-48	111,80 €	F3	86	1
JBK5-1000-400/24	107,80 €	F3	86	1
JBK5-1000-400/36	107,80 €	F3	86	1
JBK5-1000-400/400	107,80 €	F3	86	1
JBK5-1000-400/48-24	111,80 €	F3	86	1
JBK5-1000-400/6	107,80 €	F3	86	1
JBK5-1000-400-230/110	111,80 €	F3	86	1

Referencia	P.V.P.	Fam.	Pag.	Emb.
JBK5-1000-400-230/110-24	116,80 €	F3	86	1
JBK5-1000-400-230/110-48	116,80 €	F3	86	1
JBK5-1000-400-230/230	111,80 €	F3	86	1
JBK5-1000-400-230/230-110	116,80 €	F3	86	1
JBK5-1000-400-230/230-24	116,80 €	F3	86	1
JBK5-1000-400-230/230-48	116,80 €	F3	86	1
JBK5-1000-400-230/24	111,80 €	F3	86	1
JBK5-1000-400-230/48	111,80 €	F3	86	1
JBK5-1000-400-230/48-24	116,80 €	F3	86	1
JBK5-1000-48-24/24	111,80 €	F3	86	1
JBK5-1000-48-24/48	111,80 €	F3	86	1
JBK5-100-110-48/24	41,10 €	F3	86	1
JBK5-100-110-48/48	41,10 €	F3	86	1
JBK5-100-110-48/48-24	46,10 €	F3	86	1
JBK5-100-230/110	37,10 €	F3	86	1
JBK5-100-230/110-24	41,10 €	F3	86	1
JBK5-100-230/110-48	41,10 €	F3	86	1
JBK5-100-230/12	37,10 €	F3	86	1
JBK5-100-230/127	37,10 €	F3	86	1
JBK5-100-230/230	37,10 €	F3	86	1
JBK5-100-230/24	37,10 €	F3	86	1
JBK5-100-230/36	37,10 €	F3	86	1
JBK5-100-230/400	37,10 €	F3	86	1
JBK5-100-230/48-24	41,10 €	F3	86	1
JBK5-100-230/6	37,10 €	F3	86	1
JBK5-100-230-110/110	41,10 €	F3	86	1
JBK5-100-230-110/110-24	46,10 €	F3	86	1
JBK5-100-230-110/110-48	46,10 €	F3	86	1
JBK5-100-230-110/24	41,10 €	F3	86	1
JBK5-100-230-110/48	41,10 €	F3	86	1
JBK5-100-400/110	37,10 €	F3	86	1
JBK5-100-400/110-24	41,10 €	F3	86	1
JBK5-100-400/110-48	41,10 €	F3	86	1
JBK5-100-400/12	37,10 €	F3	86	1
JBK5-100-400/127	37,10 €	F3	86	1
JBK5-100-400/230	37,10 €	F3	86	1
JBK5-100-400/230-110	41,10 €	F3	86	1
JBK5-100-400/230-24	41,10 €	F3	86	1
JBK5-100-400/230-48	41,10 €	F3	86	1
JBK5-100-400/24	37,10 €	F3	86	1
JBK5-100-400/36	37,10 €	F3	86	1
JBK5-100-400/400	37,10 €	F3	86	1
JBK5-100-400/48-24	41,10 €	F3	86	1
JBK5-100-400/6	37,10 €	F3	86	1
JBK5-100-400-230/110	41,10 €	F3	86	1
JBK5-100-400-230/110-24	46,10 €	F3	86	1
JBK5-100-400-230/110-48	46,10 €	F3	86	1
JBK5-100-400-230/230	41,10 €	F3	86	1
JBK5-100-400-230/230-110	46,10 €	F3	86	1
JBK5-100-400-230/230-24	46,10 €	F3	86	1
JBK5-100-400-230/230-48	46,10 €	F3	86	1
JBK5-100-400-230/24	41,10 €	F3	86	1
JBK5-100-400-230/48	41,10 €	F3	86	1
JBK5-100-400-230/48-24	46,10 €	F3	86	1
JBK5-100-48-24/24	41,10 €	F3	86	1
JBK5-100-48-24/48	41,10 €	F3	86	1
JBK5-1600-110-48/24	118,90 €	F3	86	1
JBK5-1600-110-48/48	118,90 €	F3	86	1
JBK5-1600-110-48/48-24	123,90 €	F3	86	1
JBK5-1600-230/110	114,90 €	F3	86	1
JBK5-1600-230/110-24	118,90 €	F3	86	1
JBK5-1600-230/110-48	118,90 €	F3	86	1
JBK5-1600-230/12	114,90 €	F3	86	1
JBK5-1600-230/127	114,90 €	F3	86	1
JBK5-1600-230/230	114,90 €	F3	86	1
JBK5-1600-230/24	114,90 €	F3	86	1
JBK5-1600-230/36	114,90 €	F3	86	1
JBK5-1600-230/400	114,90 €	F3	86	1
JBK5-1600-230/48-24	118,90 €	F3	86	1
JBK5-1600-230/6	114,90 €	F3	86	1

Referencia	P.V.P.	Fam.	Pag.	Emb.
JBK5-1600-230-110/110	118,90 €	F3	86	1
JBK5-1600-230-110/110-24	123,90 €	F3	86	1
JBK5-1600-230-110/110-48	123,90 €	F3	86	1
JBK5-1600-230-110/24	118,90 €	F3	86	1
JBK5-1600-230-110/48	118,90 €	F3	86	1
JBK5-1600-400/110	114,90 €	F3	86	1
JBK5-1600-400/110-24	118,90 €	F3	86	1
JBK5-1600-400/110-48	118,90 €	F3	86	1
JBK5-1600-400/12	114,90 €	F3	86	1
JBK5-1600-400/127	114,90 €	F3	86	1
JBK5-1600-400/230	114,90 €	F3	86	1
JBK5-1600-400/230-110	118,90 €	F3	86	1
JBK5-1600-400/230-24	118,90 €	F3	86	1
JBK5-1600-400/230-48	118,90 €	F3	86	1
JBK5-1600-400/24	114,90 €	F3	86	1
JBK5-1600-400/36	114,90 €	F3	86	1
JBK5-1600-400/400	114,90 €	F3	86	1
JBK5-1600-400/48-24	118,90 €	F3	86	1
JBK5-1600-400/6	114,90 €	F3	86	1
JBK5-1600-400-230/110	118,90 €	F3	86	1
JBK5-1600-400-230/110-24	123,90 €	F3	86	1
JBK5-1600-400-230/110-48	123,90 €	F3	86	1
JBK5-1600-400-230/230	118,90 €	F3	86	1
JBK5-1600-400-230/230-110	123,90 €	F3	86	1
JBK5-1600-400-230/230-24	123,90 €	F3	86	1
JBK5-1600-400-230/230-48	123,90 €	F3	86	1
JBK5-1600-400-230/24	118,90 €	F3	86	1
JBK5-1600-400-230/48	118,90 €	F3	86	1
JBK5-1600-400-230/48-24	123,90 €	F3	86	1
JBK5-1600-48-24/24	118,90 €	F3	86	1
JBK5-1600-48-24/48	118,90 €	F3	86	1
JBK5-160-110-48/24	52,20 €	F3	86	1
JBK5-160-110-48/48	52,20 €	F3	86	1
JBK5-160-110-48/48-24	57,20 €	F3	86	1
JBK5-160-230/110	48,40 €	F3	86	1
JBK5-160-230/110-24	52,20 €	F3	86	1
JBK5-160-230/110-48	52,20 €	F3	86	1
JBK5-160-230/12	48,40 €	F3	86	1
JBK5-160-230/127	48,40 €	F3	86	1
JBK5-160-230/230	48,40 €	F3	86	1
JBK5-160-230/24	48,40 €	F3	86	1
JBK5-160-230/36	48,40 €	F3	86	1
JBK5-160-230/400	48,40 €	F3	86	1
JBK5-160-230/48-24	52,20 €	F3	86	1
JBK5-160-230/6	48,40 €	F3	86	1
JBK5-160-230-110/110	52,20 €	F3	86	1
JBK5-160-230-110/110-24	57,20 €	F3	86	1
JBK5-160-230-110/110-48	57,20 €	F3	86	1
JBK5-160-230-110/24	52,20 €	F3	86	1
JBK5-160-230-110/48	52,20 €	F3	86	1
JBK5-160-400/110	48,40 €	F3	86	1
JBK5-160-400/110-24	52,20 €	F3	86	1
JBK5-160-400/110-48	52,20 €	F3	86	1
JBK5-160-400/12	48,40 €	F3	86	1
JBK5-160-400/127	48,40 €	F3	86	1
JBK5-160-400/230	48,40 €	F3	86	1
JBK5-160-400/230-110	52,20 €	F3	86	1
JBK5-160-400/230-24	52,20 €	F3	86	1
JBK5-160-400/230-48	52,20 €	F3	86	1
JBK5-160-400/24	48,40 €	F3	86	1
JBK5-160-400/36	48,40 €	F3	86	1
JBK5-160-400/400	48,40 €	F3	86	1
JBK5-160-400/48-24	52,20 €	F3	86	1
JBK5-160-400/6	48,40 €	F3	86	1
JBK5-160-400-230/110	52,20 €	F3	86	1
JBK5-160-400-230/110-24	57,20 €	F3	86	1
JBK5-160-400-230/110-48	57,20 €	F3	86	1
JBK5-160-400-230/230	52,20 €	F3	86	1
JBK5-160-400-230/230-110	57,20 €	F3	86	1
JBK5-160-400-230/230-24	57,20 €	F3	86	1

Referencia	P.V.P.	Fam.	Pag.	Emb.
JBK5-160-400-230/230-48	57,20 €	F3	86	1
JBK5-160-400-230/24	52,20 €	F3	86	1
JBK5-160-400-230/48	52,20 €	F3	86	1
JBK5-160-400-230/48-24	57,20 €	F3	86	1
JBK5-160-48-24/24	52,20 €	F3	86	1
JBK5-160-48-24/48	52,20 €	F3	86	1
JBK5-2500-110-48/24	127,90 €	F3	86	1
JBK5-2500-110-48/48	127,90 €	F3	86	1
JBK5-2500-110-48/48-24	132,90 €	F3	86	1
JBK5-2500-230/110	123,90 €	F3	86	1
JBK5-2500-230/110-24	127,90 €	F3	86	1
JBK5-2500-230/110-48	127,90 €	F3	86	1
JBK5-2500-230/12	123,90 €	F3	86	1
JBK5-2500-230/127	123,90 €	F3	86	1
JBK5-2500-230/230	123,90 €	F3	86	1
JBK5-2500-230/24	123,90 €	F3	86	1
JBK5-2500-230/36	123,90 €	F3	86	1
JBK5-2500-230/400	123,90 €	F3	86	1
JBK5-2500-230/48-24	127,90 €	F3	86	1
JBK5-2500-230/6	123,90 €	F3	86	1
JBK5-2500-230-110/110	127,90 €	F3	86	1
JBK5-2500-230-110/110-24	132,90 €	F3	86	1
JBK5-2500-230-110/110-48	132,90 €	F3	86	1
JBK5-2500-230-110/24	127,90 €	F3	86	1
JBK5-2500-230-110/48	127,90 €	F3	86	1
JBK5-2500-400/110	123,90 €	F3	86	1
JBK5-2500-400/110-24	127,90 €	F3	86	1
JBK5-2500-400/110-48	127,90 €	F3	86	1
JBK5-2500-400/12	123,90 €	F3	86	1
JBK5-2500-400/127	123,90 €	F3	86	1
JBK5-2500-400/230	123,90 €	F3	86	1
JBK5-2500-400/230-110	127,90 €	F3	86	1
JBK5-2500-400/230-24	127,90 €	F3	86	1
JBK5-2500-400/230-48	127,90 €	F3	86	1
JBK5-2500-400/24	123,90 €	F3	86	1
JBK5-2500-400/36	123,90 €	F3	86	1
JBK5-2500-400/400	123,90 €	F3	86	1
JBK5-2500-400/48-24	127,90 €	F3	86	1
JBK5-2500-400/6	123,90 €	F3	86	1
JBK5-2500-400-230/110	127,90 €	F3	86	1
JBK5-2500-400-230/110-24	132,90 €	F3	86	1
JBK5-2500-400-230/110-48	132,90 €	F3	86	1
JBK5-2500-400-230/230	127,90 €	F3	86	1
JBK5-2500-400-230/230-110	132,90 €	F3	86	1
JBK5-2500-400-230/230-24	132,90 €	F3	86	1
JBK5-2500-400-230/230-48	132,90 €	F3	86	1
JBK5-2500-400-230/24	127,90 €	F3	86	1
JBK5-2500-400-230/48	127,90 €	F3	86	1
JBK5-2500-400-230/48-24	132,90 €	F3	86	1
JBK5-2500-48-24/24	127,90 €	F3	86	1
JBK5-2500-48-24/48	127,90 €	F3	86	1
JBK5-250-110-48/24	68,00 €	F3	86	1
JBK5-250-110-48/48	68,00 €	F3	86	1
JBK5-250-110-48/48-24	73,00 €	F3	86	1
JBK5-250-230/110	64,00 €	F3	86	1
JBK5-250-230/110-24	68,00 €	F3	86	1
JBK5-250-230/110-48	68,00 €	F3	86	1
JBK5-250-230/12	64,00 €	F3	86	1
JBK5-250-230/127	64,00 €	F3	86	1
JBK5-250-230/230	64,00 €	F3	86	1
JBK5-250-230/24	64,00 €	F3	86	1
JBK5-250-230/36	64,00 €	F3	86	1
JBK5-250-230/400	64,00 €	F3	86	1
JBK5-250-230/48-24	68,00 €	F3	86	1
JBK5-250-230/6	64,00 €	F3	86	1
JBK5-250-230-110/110	68,00 €	F3	86	1
JBK5-250-230-110/110-24	73,00 €	F3	86	1
JBK5-250-230-110/110-48	73,00 €	F3	86	1
JBK5-250-230-110/24	68,00 €	F3	86	1
JBK5-250-230-110/48	68,00 €	F3	86	1

Referencia	P.V.P.	Fam.	Pag.	Emb.
JBK5-250-400/110	64,00 €	F3	86	1
JBK5-250-400/110-24	68,00 €	F3	86	1
JBK5-250-400/110-48	68,00 €	F3	86	1
JBK5-250-400/12	64,00 €	F3	86	1
JBK5-250-400/127	64,00 €	F3	86	1
JBK5-250-400/230	64,00 €	F3	86	1
JBK5-250-400/230-110	68,00 €	F3	86	1
JBK5-250-400/230-24	68,00 €	F3	86	1
JBK5-250-400/230-48	68,00 €	F3	86	1
JBK5-250-400/24	64,00 €	F3	86	1
JBK5-250-400/36	64,00 €	F3	86	1
JBK5-250-400/400	64,00 €	F3	86	1
JBK5-250-400/48-24	68,00 €	F3	86	1
JBK5-250-400/6	64,00 €	F3	86	1
JBK5-250-400-230/110	68,00 €	F3	86	1
JBK5-250-400-230/110-24	73,00 €	F3	86	1
JBK5-250-400-230/110-48	73,00 €	F3	86	1
JBK5-250-400-230/230	68,00 €	F3	86	1
JBK5-250-400-230/230-110	73,00 €	F3	86	1
JBK5-250-400-230/230-24	73,00 €	F3	86	1
JBK5-250-400-230/230-48	73,00 €	F3	86	1
JBK5-250-400-230/24	68,00 €	F3	86	1
JBK5-250-400-230/48	68,00 €	F3	86	1
JBK5-250-400-230/48-24	73,00 €	F3	86	1
JBK5-250-48-24/24	68,00 €	F3	86	1
JBK5-250-48-24/48	68,00 €	F3	86	1
JBK5-400-110-48/24	88,50 €	F3	86	1
JBK5-400-110-48/48	88,50 €	F3	86	1
JBK5-400-110-48/48-24	93,50 €	F3	86	1
JBK5-400-230/110	84,50 €	F3	86	1
JBK5-400-230/110-24	88,50 €	F3	86	1
JBK5-400-230/110-48	88,50 €	F3	86	1
JBK5-400-230/12	84,50 €	F3	86	1
JBK5-400-230/127	84,50 €	F3	86	1
JBK5-400-230/230	84,50 €	F3	86	1
JBK5-400-230/24	84,50 €	F3	86	1
JBK5-400-230/36	84,50 €	F3	86	1
JBK5-400-230/400	84,50 €	F3	86	1
JBK5-400-230/48-24	88,50 €	F3	86	1
JBK5-400-230/6	84,50 €	F3	86	1
JBK5-400-230-110/110	88,50 €	F3	86	1
JBK5-400-230-110/110-24	93,50 €	F3	86	1
JBK5-400-230-110/110-48	93,50 €	F3	86	1
JBK5-400-230-110/24	88,50 €	F3	86	1
JBK5-400-230-110/48	88,50 €	F3	86	1
JBK5-400-400/110	84,50 €	F3	86	1
JBK5-400-400/110-24	88,50 €	F3	86	1
JBK5-400-400/110-48	88,50 €	F3	86	1
JBK5-400-400/12	84,50 €	F3	86	1
JBK5-400-400/127	84,50 €	F3	86	1
JBK5-400-400/230	84,50 €	F3	86	1
JBK5-400-400/230-110	88,50 €	F3	86	1
JBK5-400-400/230-24	88,50 €	F3	86	1
JBK5-400-400/230-48	88,50 €	F3	86	1
JBK5-400-400/24	84,50 €	F3	86	1
JBK5-400-400/36	84,50 €	F3	86	1
JBK5-400-400/400	84,50 €	F3	86	1
JBK5-400-400/48-24	88,50 €	F3	86	1
JBK5-400-400/6	84,50 €	F3	86	1
JBK5-400-400-230/110	88,50 €	F3	86	1
JBK5-400-400-230/110-24	93,50 €	F3	86	1
JBK5-400-400-230/110-48	93,50 €	F3	86	1
JBK5-400-400-230/230	88,50 €	F3	86	1
JBK5-400-400-230/230-110	93,50 €	F3	86	1
JBK5-400-400-230/230-24	93,50 €	F3	86	1
JBK5-400-400-230/230-48	93,50 €	F3	86	1
JBK5-400-400-230/24	88,50 €	F3	86	1
JBK5-400-400-230/48	88,50 €	F3	86	1
JBK5-400-400-230/48-24	93,50 €	F3	86	1
JBK5-400-48-24/24	88,50 €	F3	86	1

Referencia	P.V.P.	Fam.	Pag.	Emb.
JBK5-400-48-24/48	88,50 €	F3	86	1
JBK5-40-110-48/24	27,00 €	F3	86	1
JBK5-40-110-48/48	27,00 €	F3	86	1
JBK5-40-110-48/48-24	32,00 €	F3	86	1
JBK5-40-230/110	23,00 €	F3	86	1
JBK5-40-230/110-24	27,00 €	F3	86	1
JBK5-40-230/110-48	27,00 €	F3	86	1
JBK5-40-230/12	23,00 €	F3	86	1
JBK5-40-230/127	23,00 €	F3	86	1
JBK5-40-230/230	23,00 €	F3	86	1
JBK5-40-230/24	23,00 €	F3	86	1
JBK5-40-230/36	23,00 €	F3	86	1
JBK5-40-230/400	23,00 €	F3	86	1
JBK5-40-230/48-24	27,00 €	F3	86	1
JBK5-40-230/6	23,00 €	F3	86	1
JBK5-40-230-110/110	27,00 €	F3	86	1
JBK5-40-230-110/110-24	32,00 €	F3	86	1
JBK5-40-230-110/110-48	32,00 €	F3	86	1
JBK5-40-230-110/24	27,00 €	F3	86	1
JBK5-40-230-110/48	27,00 €	F3	86	1
JBK5-40-400/110	23,00 €	F3	86	1
JBK5-40-400/110-24	27,00 €	F3	86	1
JBK5-40-400/110-48	27,00 €	F3	86	1
JBK5-40-400/12	23,00 €	F3	86	1
JBK5-40-400/127	23,00 €	F3	86	1
JBK5-40-400/230	23,00 €	F3	86	1
JBK5-40-400/230-110	27,00 €	F3	86	1
JBK5-40-400/230-24	27,00 €	F3	86	1
JBK5-40-400/230-48	27,00 €	F3	86	1
JBK5-40-400/24	23,00 €	F3	86	1
JBK5-40-400/36	23,00 €	F3	86	1
JBK5-40-400/400	23,00 €	F3	86	1
JBK5-40-400/48-24	27,00 €	F3	86	1
JBK5-40-400/6	23,00 €	F3	86	1
JBK5-40-400-230/110	27,00 €	F3	86	1
JBK5-40-400-230/110-24	32,00 €	F3	86	1
JBK5-40-400-230/110-48	32,00 €	F3	86	1
JBK5-40-400-230/230	27,00 €	F3	86	1
JBK5-40-400-230/230-110	32,00 €	F3	86	1
JBK5-40-400-230/230-24	32,00 €	F3	86	1
JBK5-40-400-230/230-48	32,00 €	F3	86	1
JBK5-40-400-230/24	27,00 €	F3	86	1
JBK5-40-400-230/48	27,00 €	F3	86	1
JBK5-40-400-230/48-24	32,00 €	F3	86	1
JBK5-40-48-24/24	27,00 €	F3	86	1
JBK5-40-48-24/48	27,00 €	F3	86	1
JBK5-630-110-48/24	95,40 €	F3	86	1
JBK5-630-110-48/48	95,40 €	F3	86	1
JBK5-630-110-48/48-24	100,40 €	F3	86	1
JBK5-630-230/110	91,40 €	F3	86	1
JBK5-630-230/110-24	95,40 €	F3	86	1
JBK5-630-230/110-48	95,40 €	F3	86	1
JBK5-630-230/12	91,40 €	F3	86	1
JBK5-630-230/127	91,40 €	F3	86	1
JBK5-630-230/230	91,40 €	F3	86	1
JBK5-630-230/24	91,40 €	F3	86	1
JBK5-630-230/36	91,40 €	F3	86	1
JBK5-630-230/400	91,40 €	F3	86	1
JBK5-630-230/48-24	95,40 €	F3	86	1
JBK5-630-230/6	91,40 €	F3	86	1
JBK5-630-230-110/110	95,40 €	F3	86	1
JBK5-630-230-110/110-24	100,40 €	F3	86	1
JBK5-630-230-110/110-48	100,40 €	F3	86	1
JBK5-630-230-110/24	95,40 €	F3	86	1
JBK5-630-230-110/48	95,40 €	F3	86	1
JBK5-630-400/110	91,40 €	F3	86	1
JBK5-630-400/110-24	95,40 €	F3	86	1
JBK5-630-400/110-48	95,40 €	F3	86	1
JBK5-630-400/12	91,40 €	F3	86	1
JBK5-630-400/127	91,40 €	F3	86	1

Referencia	P.V.P.	Fam.	Pag.	Emb.
JBK5-630-400/230	91,40 €	F3	86	1
JBK5-630-400/230-110	95,40 €	F3	86	1
JBK5-630-400/230-24	95,40 €	F3	86	1
JBK5-630-400/230-48	95,40 €	F3	86	1
JBK5-630-400/24	91,40 €	F3	86	1
JBK5-630-400/36	91,40 €	F3	86	1
JBK5-630-400/400	91,40 €	F3	86	1
JBK5-630-400/48-24	95,40 €	F3	86	1
JBK5-630-400/6	91,40 €	F3	86	1
JBK5-630-400-230/110	95,40 €	F3	86	1
JBK5-630-400-230/110-24	100,40 €	F3	86	1
JBK5-630-400-230/110-48	100,40 €	F3	86	1
JBK5-630-400-230/230	95,40 €	F3	86	1
JBK5-630-400-230/230-110	100,40 €	F3	86	1
JBK5-630-400-230/230-24	100,40 €	F3	86	1
JBK5-630-400-230/230-48	100,40 €	F3	86	1
JBK5-630-400-230/24	95,40 €	F3	86	1
JBK5-630-400-230/48	95,40 €	F3	86	1
JBK5-630-400-230/48-24	100,40 €	F3	86	1
JBK5-630-48-24/24	95,40 €	F3	86	1
JBK5-630-48-24/48	95,40 €	F3	86	1
JBK5-63-110-48/24	29,00 €	F3	86	1
JBK5-63-110-48/48	29,00 €	F3	86	1
JBK5-63-110-48/48-24	34,00 €	F3	86	1
JBK5-63-230/110	25,00 €	F3	86	1
JBK5-63-230/110-24	29,00 €	F3	86	1
JBK5-63-230/110-48	29,00 €	F3	86	1
JBK5-63-230/12	25,00 €	F3	86	1
JBK5-63-230/127	25,00 €	F3	86	1
JBK5-63-230/230	25,00 €	F3	86	1
JBK5-63-230/24	25,00 €	F3	86	1
JBK5-63-230/36	25,00 €	F3	86	1
JBK5-63-230/400	25,00 €	F3	86	1
JBK5-63-230/48-24	29,00 €	F3	86	1
JBK5-63-230/6	25,00 €	F3	86	1
JBK5-63-230-110/110	29,00 €	F3	86	1
JBK5-63-230-110/110-24	34,00 €	F3	86	1
JBK5-63-230-110/110-48	34,00 €	F3	86	1
JBK5-63-230-110/24	29,00 €	F3	86	1
JBK5-63-230-110/48	29,00 €	F3	86	1
JBK5-63-400/110	25,00 €	F3	86	1
JBK5-63-400/110-24	29,00 €	F3	86	1
JBK5-63-400/110-48	29,00 €	F3	86	1
JBK5-63-400/12	25,00 €	F3	86	1
JBK5-63-400/127	25,00 €	F3	86	1
JBK5-63-400/230	25,00 €	F3	86	1
JBK5-63-400/230-110	29,00 €	F3	86	1
JBK5-63-400/230-24	29,00 €	F3	86	1
JBK5-63-400/230-48	29,00 €	F3	86	1
JBK5-63-400/24	25,00 €	F3	86	1
JBK5-63-400/36	25,00 €	F3	86	1
JBK5-63-400/400	25,00 €	F3	86	1
JBK5-63-400/48-24	29,00 €	F3	86	1
JBK5-63-400/6	25,00 €	F3	86	1
JBK5-63-400-230/110	29,00 €	F3	86	1
JBK5-63-400-230/110-24	34,00 €	F3	86	1
JBK5-63-400-230/110-48	34,00 €	F3	86	1
JBK5-63-400-230/230	29,00 €	F3	86	1
JBK5-63-400-230/230-110	34,00 €	F3	86	1
JBK5-63-400-230/230-24	34,00 €	F3	86	1
JBK5-63-400-230/230-48	34,00 €	F3	86	1
JBK5-63-400-230/24	29,00 €	F3	86	1
JBK5-63-400-230/48	29,00 €	F3	86	1
JBK5-63-400-230/48-24	34,00 €	F3	86	1
JBK5-63-48-24/24	29,00 €	F3	86	1
JBK5-63-48-24/48	29,00 €	F3	86	1
JDM3	60,80 €	F3	28	1
JKF8-12	216,90 €	F5	83	1
JKF8-6	180,45 €	F5	83	1
JQC-3F/12CA-1H	4,10 €	F3	82	10

Referencia	P.V.P.	Fam.	Pag.	Emb.
JQC-3F/12CA-1Z	4,65 €	F3	82	10
JQC-3F/12CC-1H	4,10 €	F3	82	10
JQC-3F/12CC-1Z	4,65 €	F3	82	10
JQC-3F/24CA-1H	4,10 €	F3	82	10
JQC-3F/24CA-1Z	4,65 €	F3	82	10
JQC-3F/24CC-1H	4,10 €	F3	82	10
JQC-3F/24CC-1Z	4,65 €	F3	82	10
JQC-3F/3CA-1H	4,10 €	F3	82	10
JQC-3F/3CA-1Z	4,65 €	F3	82	10
JQC-3F/3CC-1H	4,10 €	F3	82	10
JQC-3F/3CC-1Z	4,65 €	F3	82	10
JQC-3F/48CA-1H	4,10 €	F3	82	10
JQC-3F/48CA-1Z	4,65 €	F3	82	10
JQC-3F/48CC-1H	4,10 €	F3	82	10
JQC-3F/48CC-1Z	4,65 €	F3	82	10
JQC-3F/6CA-1H	4,10 €	F3	82	10
JQC-3F/6CA-1Z	4,65 €	F3	82	10
JQC-3F/6CC-1H	4,10 €	F3	82	10
JQC-3F/6CC-1Z	4,65 €	F3	82	10
JQC-3F/9CA-1H	4,10 €	F3	82	10
JQC-3F/9CA-1Z	4,65 €	F3	82	10
JQC-3F/9CC-1H	4,10 €	F3	82	10
JQC-3F/9CC-1Z	4,65 €	F3	82	10
JQX-10F/110CA-2Z	14,30 €	F3	81	10
JQX-10F/110CA-3Z	16,20 €	F3	81	10
JQX-10F/110CC-2Z	15,30 €	F3	81	10
JQX-10F/110CC-3Z	17,20 €	F3	81	10
JQX-10F/127CA-2Z	14,30 €	F3	81	10
JQX-10F/127CA-3Z	16,20 €	F3	81	10
JQX-10F/127CC-2Z	15,30 €	F3	81	10
JQX-10F/127CC-3Z	17,20 €	F3	81	10
JQX-10F/12CA-2Z	14,30 €	F3	81	10
JQX-10F/12CA-3Z	16,20 €	F3	81	10
JQX-10F/12CC-2Z	15,30 €	F3	81	10
JQX-10F/12CC-3Z	17,20 €	F3	81	10
JQX-10F/220CA-2Z	14,30 €	F3	81	10
JQX-10F/220CA-3Z	16,20 €	F3	81	10
JQX-10F/220CC-2Z	15,30 €	F3	81	10
JQX-10F/220CC-3Z	17,20 €	F3	81	10
JQX-10F/24CA-2Z	14,30 €	F3	81	10
JQX-10F/24CA-3Z	16,20 €	F3	81	10
JQX-10F/24CC-2Z	15,30 €	F3	81	10
JQX-10F/24CC-3Z	17,20 €	F3	81	10
JQX-10F/36CA-2Z	14,30 €	F3	81	10
JQX-10F/36CA-3Z	16,20 €	F3	81	10
JQX-10F/36CC-2Z	15,30 €	F3	81	10
JQX-10F/36CC-3Z	17,20 €	F3	81	10
JQX-10F/380CA-2Z	14,30 €	F3	81	10
JQX-10F/380CA-3Z	16,20 €	F3	81	10
JQX-10F/48CA-2Z	14,30 €	F3	81	10
JQX-10F/48CA-3Z	16,20 €	F3	81	10
JQX-10F/48CC-2Z	15,30 €	F3	81	10
JQX-10F/48CC-3Z	17,20 €	F3	81	10
JQX-10F/6CA-2Z	14,30 €	F3	81	10
JQX-10F/6CA-3Z	16,20 €	F3	81	10
JQX-10F/6CC-2Z	15,30 €	F3	81	10
JQX-10F/6CC-3Z	17,20 €	F3	81	10
JQX-13F/D/110CA-2Z/6	14,30 €	F3	81	10
JQX-13F/D/110CC-2Z/6	15,30 €	F3	81	10
JQX-13F/D/125CC-2Z/6	15,30 €	F3	81	10
JQX-13F/D/127CA-2Z/6	14,30 €	F3	81	10
JQX-13F/D/12CA-2Z/6	14,30 €	F3	81	10
JQX-13F/D/12CC-2Z/6	15,30 €	F3	81	10
JQX-13F/D/220CA-2Z/6	14,30 €	F3	81	10
JQX-13F/D/220CC-2Z/6	15,30 €	F3	81	10
JQX-13F/D/24CA-2Z/6	14,30 €	F3	81	10
JQX-13F/D/24CC-2Z/6	15,30 €	F3	81	10
JQX-13F/D/36CA-2Z/6	14,30 €	F3	81	10
JQX-13F/D/36CC-2Z/6	15,30 €	F3	81	10
JQX-13F/D/380CA-2Z/6	14,30 €	F3	81	10

Referencia	P.V.P.	Fam.	Pag.	Emb.
JQX- 13F/D/48CA- 2Z/6	14,30 €	F3	81	10
JQX- 13F/D/48CC- 2Z/6	15,30 €	F3	81	10
JQX- 13F/D/6CA- 2Z/6	14,30 €	F3	81	10
JQX- 13F/D/6CC- 2Z/6	15,30 €	F3	81	10
JTX- 2C/110CA	14,30 €	F3	81	10
JTX- 2C/110CC	15,30 €	F3	81	10
JTX- 2C/12CA	14,30 €	F3	81	10
JTX- 2C/12CC	15,30 €	F3	81	10
JTX- 2C/220CA	14,30 €	F3	81	10
JTX- 2C/220CC	15,30 €	F3	81	10
JTX- 2C/24CA	14,30 €	F3	81	10
JTX- 2C/24CC	15,30 €	F3	81	10
JTX- 2C/36CC	15,30 €	F3	81	10
JTX- 2C/380CA	14,30 €	F3	81	10
JTX- 2C/48CA	14,30 €	F3	81	10
JTX- 2C/48CC	15,30 €	F3	81	10
JTX- 2C/6CA	14,30 €	F3	81	10
JTX- 2C/6CC	15,30 €	F3	81	10
JTX- 3C/110CA	16,20 €	F3	81	10
JTX- 3C/110CC	17,20 €	F3	81	10
JTX- 3C/13CA	16,20 €	F3	81	10
JTX- 3C/13CC	17,20 €	F3	81	10
JTX- 3C/220CA	16,20 €	F3	81	10
JTX- 3C/220CC	17,20 €	F3	81	10
JTX- 3C/24CA	16,20 €	F3	81	10
JTX- 3C/24CC	17,20 €	F3	81	10
JTX- 3C/36CC	17,20 €	F3	81	10
JTX- 3C/380CA	16,20 €	F3	81	10
JTX- 3C/48CA	16,20 €	F3	81	10
JTX- 3C/48CC	17,20 €	F3	81	10
JTX- 3C/6CA	16,20 €	F3	81	10
JTX- 3C/6CC	17,20 €	F3	81	10
JXF- 100100/30	469,90 €	F5	102	1
JXF- 10060/25	281,40 €	F5	102	1
JXF- 10060/30	294,00 €	F5	102	1
JXF- 10060/40	315,00 €	F5	102	1
JXF- 10060/45	351,80 €	F5	102	1
JXF- 10080/25	309,80 €	F5	102	1
JXF- 10080/30	345,50 €	F5	102	1
JXF- 10080/40	362,30 €	F5	102	1
JXF- 10080/45	446,30 €	F5	102	1
JXF- 120100/30	577,10 €	F5	102	1
JXF- 12080/25	351,80 €	F5	102	1
JXF- 12080/30	409,50 €	F5	102	1
JXF- 12080/40	459,90 €	F5	102	1
JXF- 12080/45	478,80 €	F5	102	1
JXF- 2520/15	45,10 €	F5	102	1
JXF- 3025/15	47,30 €	F5	102	1
JXF- 3025/20	50,40 €	F5	102	1
JXF- 3030/15	49,40 €	F5	102	1
JXF- 3030/20	54,60 €	F5	102	1
JXF- 3040/15	54,60 €	F5	102	1
JXF- 3040/20	60,90 €	F5	102	1
JXF- 4030/15	54,60 €	F5	102	1
JXF- 4030/20	60,90 €	F5	102	1
JXF- 4040/20	75,20 €	F5	102	1
JXF- 4050/15	88,20 €	F5	102	1
JXF- 4050/20	96,60 €	F5	102	1
JXF- 4050/25	102,90 €	F5	102	1
JXF- 4060/25	116,30 €	F5	102	1
JXF- 5040/15	88,20 €	F5	102	1
JXF- 5040/20	96,60 €	F5	102	1
JXF- 5040/25	102,90 €	F5	102	1
JXF- 5050/25	123,20 €	F5	102	1
JXF- 6040/15	93,40 €	F5	102	1
JXF- 6040/20	102,90 €	F5	102	1
JXF- 6040/25	115,50 €	F5	102	1
JXF- 6050/15	100,80 €	F5	102	1
JXF- 6050/20	110,30 €	F5	102	1
JXF- 6050/25	113,40 €	F5	102	1

Referencia	P.V.P.	Fam.	Pag.	Emb.
JXF- 6060/25	123,60 €	F5	102	1
JXF- 6060/30	129,00 €	F5	102	1
JXF- 7050/15	120,80 €	F5	102	1
JXF- 7050/20	134,40 €	F5	102	1
JXF- 7050/25	136,40 €	F5	102	1
JXF- 7050/30	138,60 €	F5	102	1
JXF- 8060/20	203,70 €	F5	102	1
JXF- 8060/25	220,50 €	F5	102	1
JXF- 8060/30	237,30 €	F5	102	1
JXF- 8060/40	257,50 €	F5	102	1
JXF- 8080/20	286,40 €	F5	102	1
JXF- 8080/30	298,00 €	F5	102	1
JZX- 22F/D/110CA- 2ZS/1	5,65 €	F3	82	10
JZX- 22F/D/110CA- 2ZS/6	5,65 €	F3	82	10
JZX- 22F/D/110CA- 3ZS/1	5,85 €	F3	82	10
JZX- 22F/D/110CA- 3ZS/6	5,85 €	F3	82	10
JZX- 22F/D/110CA- 4ZS/1	6,50 €	F3	82	10
JZX- 22F/D/110CA- 4ZS/6	6,15 €	F3	82	10
JZX- 22F/D/110CC- 2ZS/1	5,65 €	F3	82	10
JZX- 22F/D/110CC- 2ZS/6	5,65 €	F3	82	10
JZX- 22F/D/110CC- 3ZS/1	5,85 €	F3	82	10
JZX- 22F/D/110CC- 3ZS/6	5,85 €	F3	82	10
JZX- 22F/D/110CC- 4ZS/1	6,50 €	F3	82	10
JZX- 22F/D/110CC- 4ZS/6	6,15 €	F3	82	10
JZX- 22F/D/125CC- 2ZS/1	5,65 €	F3	82	10
JZX- 22F/D/125CC- 2ZS/6	5,65 €	F3	82	10
JZX- 22F/D/125CC- 3ZS/1	5,85 €	F3	82	10
JZX- 22F/D/125CC- 3ZS/6	5,85 €	F3	82	10
JZX- 22F/D/125CC- 4ZS/1	6,50 €	F3	82	10
JZX- 22F/D/125CC- 4ZS/6	6,15 €	F3	82	10
JZX- 22F/D/127CA- 2ZS/1	5,65 €	F3	82	10
JZX- 22F/D/127CA- 2ZS/6	5,65 €	F3	82	10
JZX- 22F/D/127CA- 3ZS/1	5,85 €	F3	82	10
JZX- 22F/D/127CA- 3ZS/6	5,85 €	F3	82	10
JZX- 22F/D/127CA- 4ZS/1	6,50 €	F3	82	10
JZX- 22F/D/127CA- 4ZS/6	6,15 €	F3	82	10
JZX- 22F/D/12CA- 2ZS/1	5,65 €	F3	82	10
JZX- 22F/D/12CA- 2ZS/6	5,65 €	F3	82	10
JZX- 22F/D/12CA- 3ZS/1	5,85 €	F3	82	10
JZX- 22F/D/12CA- 3ZS/6	5,85 €	F3	82	10
JZX- 22F/D/12CA- 4ZS/1	6,50 €	F3	82	10
JZX- 22F/D/12CA- 4ZS/6	6,15 €	F3	82	10
JZX- 22F/D/12CC- 2ZS/1	5,65 €	F3	82	10
JZX- 22F/D/12CC- 2ZS/6	5,65 €	F3	82	10
JZX- 22F/D/12CC- 3ZS/1	5,85 €	F3	82	10
JZX- 22F/D/12CC- 3ZS/6	5,85 €	F3	82	10
JZX- 22F/D/12CC- 4ZS/1	6,50 €	F3	82	10
JZX- 22F/D/12CC- 4ZS/6	6,15 €	F3	82	10
JZX- 22F/D/1CC- 2ZS/1	5,65 €	F3	82	10
JZX- 22F/D/1CC- 3ZS/1	5,85 €	F3	82	10
JZX- 22F/D/1CC- 4ZS/1	6,50 €	F3	82	10
JZX- 22F/D/220CA- 2ZS/1	5,65 €	F3	82	10
JZX- 22F/D/220CA- 2ZS/6	5,65 €	F3	82	10
JZX- 22F/D/220CA- 3ZS/1	5,85 €	F3	82	10
JZX- 22F/D/220CA- 3ZS/6	5,85 €	F3	82	10
JZX- 22F/D/220CA- 4ZS/1	6,50 €	F3	82	10
JZX- 22F/D/220CA- 4ZS/6	6,15 €	F3	82	10
JZX- 22F/D/220CC- 2ZS/1	5,65 €	F3	82	10
JZX- 22F/D/220CC- 2ZS/6	5,65 €	F3	82	10
JZX- 22F/D/220CC- 3ZS/1	5,85 €	F3	82	10
JZX- 22F/D/220CC- 3ZS/6	5,85 €	F3	82	10
JZX- 22F/D/220CC- 4ZS/1	6,50 €	F3	82	10
JZX- 22F/D/220CC- 4ZS/6	6,15 €	F3	82	10
JZX- 22F/D/24CA- 2ZS/1	5,65 €	F3	82	10
JZX- 22F/D/24CA- 2ZS/6	5,65 €	F3	82	10
JZX- 22F/D/24CA- 3ZS/1	5,85 €	F3	82	10
JZX- 22F/D/24CA- 3ZS/6	5,85 €	F3	82	10
JZX- 22F/D/24CA- 4ZS/1	6,50 €	F3	82	10
JZX- 22F/D/24CA- 4ZS/6	6,15 €	F3	82	10
JZX- 22F/D/24CC- 2ZS/1	5,65 €	F3	82	10

Referencia	P.V.P.	Fam.	Pag.	Emb.
JZX-22F/D/24CC-2ZS/6	5,65 €	F3	82	10
JZX-22F/D/24CC-3ZS/1	5,85 €	F3	82	10
JZX-22F/D/24CC-3ZS/6	5,85 €	F3	82	10
JZX-22F/D/24CC-4ZS/1	6,50 €	F3	82	10
JZX-22F/D/24CC-4ZS/6	6,15 €	F3	82	10
JZX-22F/D/36CA-2ZS/1	5,65 €	F3	82	10
JZX-22F/D/36CA-2ZS/6	5,65 €	F3	82	10
JZX-22F/D/36CA-3ZS/1	5,85 €	F3	82	10
JZX-22F/D/36CA-3ZS/6	5,85 €	F3	82	10
JZX-22F/D/36CA-4ZS/1	6,50 €	F3	82	10
JZX-22F/D/36CA-4ZS/6	6,15 €	F3	82	10
JZX-22F/D/36CC-2ZS/1	5,65 €	F3	82	10
JZX-22F/D/36CC-2ZS/6	5,65 €	F3	82	10
JZX-22F/D/36CC-3ZS/1	5,85 €	F3	82	10
JZX-22F/D/36CC-3ZS/6	5,85 €	F3	82	10
JZX-22F/D/36CC-4ZS/1	6,50 €	F3	82	10
JZX-22F/D/36CC-4ZS/6	6,15 €	F3	82	10
JZX-22F/D/380CA-2ZS/1	5,65 €	F3	82	10
JZX-22F/D/380CA-2ZS/6	5,65 €	F3	82	10
JZX-22F/D/380CA-3ZS/1	5,85 €	F3	82	10
JZX-22F/D/380CA-3ZS/6	5,85 €	F3	82	10
JZX-22F/D/380CA-4ZS/1	6,50 €	F3	82	10
JZX-22F/D/380CA-4ZS/6	6,15 €	F3	82	10
JZX-22F/D/48CA-2ZS/1	5,65 €	F3	82	10
JZX-22F/D/48CA-2ZS/6	5,65 €	F3	82	10
JZX-22F/D/48CA-3ZS/1	5,85 €	F3	82	10
JZX-22F/D/48CA-3ZS/6	5,85 €	F3	82	10
JZX-22F/D/48CA-4ZS/1	6,50 €	F3	82	10
JZX-22F/D/48CA-4ZS/6	6,15 €	F3	82	10
JZX-22F/D/48CC-2ZS/1	5,65 €	F3	82	10
JZX-22F/D/48CC-2ZS/6	5,65 €	F3	82	10
JZX-22F/D/48CC-3ZS/1	5,85 €	F3	82	10
JZX-22F/D/48CC-3ZS/6	5,85 €	F3	82	10
JZX-22F/D/48CC-4ZS/1	6,50 €	F3	82	10
JZX-22F/D/48CC-4ZS/6	6,15 €	F3	82	10
JZX-22F/D/6CA-2ZS/1	5,65 €	F3	82	10
JZX-22F/D/6CA-2ZS/6	5,65 €	F3	82	10
JZX-22F/D/6CA-3ZS/1	5,85 €	F3	82	10
JZX-22F/D/6CA-3ZS/6	5,85 €	F3	82	10
JZX-22F/D/6CA-4ZS/1	6,50 €	F3	82	10
JZX-22F/D/6CA-4ZS/6	6,15 €	F3	82	10
JZX-22F/D/6CC-2ZS/6	5,65 €	F3	82	10
JZX-22F/D/6CC-3ZS/6	5,85 €	F3	82	10
JZX-22F/D/6CC-4ZS/6	6,15 €	F3	82	10
KG10D-1Z	50,60 €	F4	28	1
KK	14,70 €	F2	53	1
KL	14,70 €	F2	53	1
LED110B	16,50 €	F1	74	10
LED110G	16,50 €	F1	74	10
LED110R	16,50 €	F1	74	10
LED110W	16,50 €	F1	74	10
LED110Y	16,50 €	F1	74	10
LED12B	16,50 €	F1	74	10
LED12G	16,50 €	F1	74	10
LED12R	16,50 €	F1	74	10
LED12W	16,50 €	F1	74	10
LED12Y	16,50 €	F1	74	10
LED230B	16,50 €	F1	74	10
LED230G	16,50 €	F1	74	10
LED230R	16,50 €	F1	74	10
LED230W	16,50 €	F1	74	10
LED230Y	16,50 €	F1	74	10
LED24B	16,50 €	F1	74	10
LED24G	16,50 €	F1	74	10
LED24R	16,50 €	F1	74	10
LED24W	16,50 €	F1	74	10
LED24Y	16,50 €	F1	74	10
LED48B	16,50 €	F1	74	10
LED48G	16,50 €	F1	74	10
LED48R	16,50 €	F1	74	10

Referencia	P.V.P.	Fam.	Pag.	Emb.
LED48W	16,50 €	F1	74	10
LED48Y	16,50 €	F1	74	10
LED6B	16,50 €	F1	74	10
LED6G	16,50 €	F1	74	10
LED6R	16,50 €	F1	74	10
LED6W	16,50 €	F1	74	10
LED6Y	16,50 €	F1	74	10
LL	17,40 €	F2	53	1
LLM	3,00 €	F5	124	1
LLP	2,50 €	F5	124	1
MA1-PADLOCK	69,90 €	F4	45	1
NA1-2000/1000-3P-EM	5.076,00 €	F4	44	1
NA1-2000/1000-3P-FM	3.714,00 €	F4	43	1
NA1-2000/1000-4P-EM	6.186,00 €	F4	44	1
NA1-2000/1000-4P-FM	4.486,00 €	F4	43	1
NA1-2000/1250-3P-EM	5.159,00 €	F4	44	1
NA1-2000/1250-3P-FM	3.864,00 €	F4	43	1
NA1-2000/1250-4P-EM	6.315,00 €	F4	44	1
NA1-2000/1250-4P-FM	4.570,00 €	F4	43	1
NA1-2000/1600-3P-EM	5.920,00 €	F4	44	1
NA1-2000/1600-3P-FM	4.309,00 €	F4	43	1
NA1-2000/1600-4P-EM	7.192,00 €	F4	44	1
NA1-2000/1600-4P-FM	5.120,00 €	F4	43	1
NA1-2000/2000-3P-EM	8.897,00 €	F4	44	1
NA1-2000/2000-3P-FM	5.509,00 €	F4	43	1
NA1-2000/2000-4P-EM	9.186,00 €	F4	44	1
NA1-2000/2000-4P-FM	6.675,00 €	F4	43	1
NA1-2000/630-3P-EM	4.380,00 €	F4	44	1
NA1-2000/630-3P-FM	3.348,00 €	F4	43	1
NA1-2000/630-4P-EM	5.276,00 €	F4	44	1
NA1-2000/630-4P-FM	3.898,00 €	F4	43	1
NA1-2000/800-3P-EM	4.682,00 €	F4	44	1
NA1-2000/800-3P-FM	3.621,00 €	F4	43	1
NA1-2000/800-4P-EM	5.510,00 €	F4	44	1
NA1-2000/800-4P-FM	4.195,00 €	F4	43	1
NA1-3200/2000-3P-EM	9.015,00 €	F4	44	1
NA1-3200/2000-3P-FM	6.742,00 €	F4	43	1
NA1-3200/2000-4P-EM	10.423,00 €	F4	44	1
NA1-3200/2000-4P-FM	8.098,00 €	F4	43	1
NA1-3200/2500-3P-EM	9.386,00 €	F4	44	1
NA1-3200/2500-3P-FM	6.964,00 €	F4	43	1
NA1-3200/2500-4P-EM	10.979,00 €	F4	44	1
NA1-3200/2500-4P-FM	8.409,00 €	F4	43	1
NA1-3200/3200-3P-EM	13.857,00 €	F4	44	1
NA1-3200/3200-3P-FM	10.170,00 €	F4	43	1
NA1-3200/3200-4P-EM	15.662,00 €	F4	44	1
NA1-3200/3200-4P-FM	12.455,00 €	F4	43	1
NA1-4000/3200-3P-EM	17.490,00 €	F4	44	1
NA1-4000/3200-3P-FM	11.876,00 €	F4	43	1
NA1-4000/3200-4P-EM	23.112,00 €	F4	44	1
NA1-4000/4000-3P-EM	19.758,00 €	F4	44	1
NA1-4000/4000-3P-FM	13.587,00 €	F4	43	1
NA1-4000/4000-4P-EM	23.390,00 €	F4	44	1
NA1-6300/4000-3P-EM	25.223,00 €	F4	44	1
NA1-6300/4000-4P-EM	28.668,00 €	F4	44	1
NA1-6300/5000-3P-EM	26.485,00 €	F4	44	1
NA1-6300/5000-4P-EM	28.861,00 €	F4	44	1
NA1-6300/6300-3P-EM	33.459,00 €	F4	44	1
NA1-AC26	78,80 €	F4	45	1
NA1-AC35	78,80 €	F4	45	1
NA1-AC53	78,80 €	F4	45	1
NA1-AC62	78,80 €	F4	45	1
NA1-CABLOCK	69,90 €	F4	45	1
NA1-CC110VCC	145,80 €	F4	45	1
NA1-CC220VCC	145,80 €	F4	45	1
NA1-CC230VCA	133,30 €	F4	45	1
NA1-CC400VCA	133,30 €	F4	45	1
NA1-KEYLOCK	81,10 €	F4	45	1
NA1-MECKLOCK	225,50 €	F4	45	1
NA1-MOT220VCC	786,40 €	F4	45	1

Referencia	P.V.P.	Fam.	Pag.	Emb.
NA1-MOT230VCA	725,50 €	F4	45	1
NA1-MOT400VCA	725,50 €	F4	45	1
NA1-SHT110VCC	126,90 €	F4	45	1
NA1-SHT220VCC	126,90 €	F4	45	1
NA1-SHT230VCA	112,10 €	F4	45	1
NA1-SHT400VCA	112,10 €	F4	45	1
NA1-UVT110VCC	321,30 €	F4	45	1
NA1-UVT220VCC	321,30 €	F4	45	1
NA1-UVT230VCA	277,70 €	F4	45	1
NA1-UVT400VCA	277,70 €	F4	45	1
NA1-UVTR110VCC-0,5	333,30 €	F4	45	1
NA1-UVTR110VCC-1	333,30 €	F4	45	1
NA1-UVTR110VCC-2	333,30 €	F4	45	1
NA1-UVTR110VCC-3	333,30 €	F4	45	1
NA1-UVTR220VCC-0,5	333,30 €	F4	45	1
NA1-UVTR220VCC-1	333,30 €	F4	45	1
NA1-UVTR220VCC-2	333,30 €	F4	45	1
NA1-UVTR220VCC-3	333,30 €	F4	45	1
NA1-UVTR230VCA-0,5	299,90 €	F4	45	1
NA1-UVTR230VCA-1	299,90 €	F4	45	1
NA1-UVTR230VCA-2	299,90 €	F4	45	1
NA1-UVTR230VCA-3	299,90 €	F4	45	1
NA1-UVTR400VCA-0,5	299,90 €	F4	45	1
NA1-UVTR400VCA-1	299,90 €	F4	45	1
NA1-UVTR400VCA-2	299,90 €	F4	45	1
NA1-UVTR400VCA-3	299,90 €	F4	45	1
NB1-1-10B	14,00 €	F3	5	12/180
NB1-1-10B10	19,20 €	F2	7	12/180
NB1-1-10C	13,70 €	F1	5	12/180
NB1-1-10C10	18,00 €	F2	7	12/180
NB1-1-10CC47	18,50 €	F2	9	12/180
NB1-1-10CC715	19,60 €	F2	9	12/180
NB1-1-10D	17,70 €	F3	5	12/180
NB1-1-10D10	20,80 €	F2	7	12/180
NB1-1-16B	14,00 €	F3	5	12/180
NB1-1-16B10	19,20 €	F2	7	12/180
NB1-1-16C	13,70 €	F1	5	12/180
NB1-1-16C10	18,00 €	F2	7	12/180
NB1-1-16CC47	18,50 €	F2	9	12/180
NB1-1-16CC715	19,60 €	F2	9	12/180
NB1-1-16D	17,70 €	F3	5	12/180
NB1-1-16D10	20,80 €	F2	7	12/180
NB1-1-1B	15,50 €	F3	5	12/180
NB1-1-1B10	27,40 €	F2	7	12/180
NB1-1-1C	14,80 €	F1	5	12/180
NB1-1-1C10	26,10 €	F2	7	12/180
NB1-1-1CC47	30,80 €	F2	9	12/180
NB1-1-1CC715	33,50 €	F2	9	12/180
NB1-1-1D	21,20 €	F3	5	12/180
NB1-1-1D10	29,20 €	F2	7	12/180
NB1-1-20B	14,00 €	F3	5	12/180
NB1-1-20B10	19,20 €	F2	7	12/180
NB1-1-20C	13,70 €	F1	5	12/180
NB1-1-20C10	18,00 €	F2	7	12/180
NB1-1-20CC47	18,50 €	F2	9	12/180
NB1-1-20CC715	19,60 €	F2	9	12/180
NB1-1-20D	17,70 €	F3	5	12/180
NB1-1-20D10	20,80 €	F2	7	12/180
NB1-1-25B	14,00 €	F3	5	12/180
NB1-1-25B10	19,20 €	F2	7	12/180
NB1-1-25C	13,70 €	F1	5	12/180
NB1-1-25C10	18,00 €	F2	7	12/180
NB1-1-25CC47	18,50 €	F2	9	12/180
NB1-1-25CC715	19,60 €	F2	9	12/180
NB1-1-25D	17,70 €	F3	5	12/180
NB1-1-25D10	20,80 €	F2	7	12/180
NB1-1-2B	15,50 €	F3	5	12/180
NB1-1-2B10	27,40 €	F2	7	12/180
NB1-1-2C	14,80 €	F1	5	12/180
NB1-1-2C10	26,10 €	F2	7	12/180

Referencia	P.V.P.	Fam.	Pag.	Emb.
NB1-1-2CC47	30,80 €	F2	9	12/180
NB1-1-2CC715	33,50 €	F2	9	12/180
NB1-1-2D	21,20 €	F3	5	12/180
NB1-1-2D10	29,20 €	F2	7	12/180
NB1-1-32B	14,00 €	F3	5	12/180
NB1-1-32B10	19,20 €	F2	7	12/180
NB1-1-32C	14,00 €	F1	5	12/180
NB1-1-32C10	18,00 €	F2	7	12/180
NB1-1-32CC47	18,50 €	F2	9	12/180
NB1-1-32CC715	19,60 €	F2	9	12/180
NB1-1-32D	17,70 €	F3	5	12/180
NB1-1-32D10	20,80 €	F2	7	12/180
NB1-1-3B	15,50 €	F3	5	12/180
NB1-1-3B10	27,40 €	F2	7	12/180
NB1-1-3C	14,80 €	F1	5	12/180
NB1-1-3C10	26,10 €	F2	7	12/180
NB1-1-3CC47	30,80 €	F2	9	12/180
NB1-1-3CC715	33,50 €	F2	9	12/180
NB1-1-3D	21,20 €	F3	5	12/180
NB1-1-3D10	29,20 €	F2	7	12/180
NB1-1-40B	20,80 €	F3	5	12/180
NB1-1-40B10	23,90 €	F2	7	12/180
NB1-1-40C	15,30 €	F1	5	12/180
NB1-1-40C10	22,90 €	F2	7	12/180
NB1-1-40CC47	27,00 €	F2	9	12/180
NB1-1-40CC715	30,50 €	F2	9	12/180
NB1-1-40D	21,40 €	F3	5	12/180
NB1-1-40D10	25,80 €	F2	7	12/180
NB1-1-4B	15,50 €	F3	5	12/180
NB1-1-4B10	27,40 €	F2	7	12/180
NB1-1-4C	14,80 €	F1	5	12/180
NB1-1-4C10	26,10 €	F2	7	12/180
NB1-1-4CC47	30,80 €	F2	9	12/180
NB1-1-4CC715	33,50 €	F2	9	12/180
NB1-1-4D	21,20 €	F3	5	12/180
NB1-1-4D10	29,20 €	F2	7	12/180
NB1-1-50B	30,60 €	F3	5	12/180
NB1-1-50B10	36,50 €	F2	7	12/180
NB1-1-50C	28,20 €	F1	5	12/180
NB1-1-50C10	34,70 €	F2	7	12/180
NB1-1-50CC47	30,80 €	F2	9	12/180
NB1-1-50CC715	33,50 €	F2	9	12/180
NB1-1-50D	33,20 €	F3	5	12/180
NB1-1-50D10	39,20 €	F2	7	12/180
NB1-1-63B	36,20 €	F3	5	12/180
NB1-1-63B10	45,90 €	F2	7	12/180
NB1-1-63C	31,30 €	F1	5	12/180
NB1-1-63C10	42,90 €	F2	7	12/180
NB1-1-63CC47	51,40 €	F2	9	12/180
NB1-1-63CC715	54,90 €	F2	9	12/180
NB1-1-63D	40,10 €	F3	5	12/180
NB1-1-63D10	47,60 €	F2	7	12/180
NB1-1-6B	14,00 €	F3	5	12/180
NB1-1-6B10	19,20 €	F2	7	12/180
NB1-1-6C	13,70 €	F1	5	12/180
NB1-1-6C10	18,00 €	F2	7	12/180
NB1-1-6CC47	18,50 €	F2	9	12/180
NB1-1-6CC715	19,60 €	F2	9	12/180
NB1-1-6D	17,70 €	F3	5	12/180
NB1-1-6D10	20,80 €	F2	7	12/180
NB1-2-10B	29,40 €	F3	5	6/90
NB1-2-10B10	37,70 €	F2	7	6/90
NB1-2-10C	27,80 €	F1	5	6/90
NB1-2-10C10	36,50 €	F2	7	6/90
NB1-2-10CC47	40,00 €	F2	9	6/90
NB1-2-10CC715	41,20 €	F2	9	6/90
NB1-2-10D	36,40 €	F3	5	6/90
NB1-2-10D10	38,50 €	F2	7	6/90
NB1-2-16B	29,40 €	F3	5	6/90
NB1-2-16B10	37,70 €	F2	7	6/90

Referencia	P.V.P.	Fam.	Pag.	Emb.
NB1-2-16C	27,80 €	F1	5	6/90
NB1-2-16C10	36,50 €	F2	7	6/90
NB1-2-16CC47	40,00 €	F2	9	6/90
NB1-2-16CC715	41,20 €	F2	9	6/90
NB1-2-16D	36,40 €	F3	5	6/90
NB1-2-16D10	38,50 €	F2	7	6/90
NB1-2-1B	31,20 €	F3	5	6/90
NB1-2-1B10	44,70 €	F2	7	6/90
NB1-2-1C	30,20 €	F1	5	6/90
NB1-2-1C10	42,30 €	F2	7	6/90
NB1-2-1CC47	50,60 €	F2	9	6/90
NB1-2-1CC715	51,70 €	F2	9	6/90
NB1-2-1D	44,80 €	F3	5	6/90
NB1-2-1D10	49,70 €	F2	7	6/90
NB1-2-20B	29,40 €	F3	5	6/90
NB1-2-20B10	37,70 €	F2	7	6/90
NB1-2-20C	27,80 €	F1	5	6/90
NB1-2-20C10	36,50 €	F2	7	6/90
NB1-2-20CC47	40,00 €	F2	9	6/90
NB1-2-20CC715	41,20 €	F2	9	6/90
NB1-2-20D	36,40 €	F3	5	6/90
NB1-2-20D10	38,50 €	F2	7	6/90
NB1-2-25B	29,40 €	F3	5	6/90
NB1-2-25B10	37,70 €	F2	7	6/90
NB1-2-25C	27,80 €	F1	5	6/90
NB1-2-25C10	36,50 €	F2	7	6/90
NB1-2-25CC47	40,00 €	F2	9	6/90
NB1-2-25CC715	41,20 €	F2	9	6/90
NB1-2-25D	36,40 €	F3	5	6/90
NB1-2-25D10	38,50 €	F2	7	6/90
NB1-2-2B	31,20 €	F3	5	6/90
NB1-2-2B10	44,70 €	F2	7	6/90
NB1-2-2C	30,20 €	F1	5	6/90
NB1-2-2C10	42,30 €	F2	7	6/90
NB1-2-2CC47	50,60 €	F2	9	6/90
NB1-2-2CC715	51,70 €	F2	9	6/90
NB1-2-2D	44,80 €	F3	5	6/90
NB1-2-2D10	49,70 €	F2	7	6/90
NB1-2-32B	29,40 €	F3	5	6/90
NB1-2-32B10	37,70 €	F2	7	6/90
NB1-2-32C	28,20 €	F1	5	6/90
NB1-2-32C10	36,50 €	F2	7	6/90
NB1-2-32CC47	40,00 €	F2	9	6/90
NB1-2-32CC715	41,20 €	F2	9	6/90
NB1-2-32D	36,40 €	F3	5	6/90
NB1-2-32D10	38,50 €	F2	7	6/90
NB1-2-3B	31,20 €	F3	5	6/90
NB1-2-3B10	44,70 €	F2	7	6/90
NB1-2-3C	30,20 €	F1	5	6/90
NB1-2-3C10	42,30 €	F2	7	6/90
NB1-2-3CC47	50,60 €	F2	9	6/90
NB1-2-3CC715	51,70 €	F2	9	6/90
NB1-2-3D	44,80 €	F3	5	6/90
NB1-2-3D10	49,70 €	F2	7	6/90
NB1-2-40B	37,90 €	F3	5	6/90
NB1-2-40B10	48,40 €	F2	7	6/90
NB1-2-40C	36,10 €	F1	5	6/90
NB1-2-40C10	47,60 €	F2	7	6/90
NB1-2-40CC47	52,90 €	F2	9	6/90
NB1-2-40CC715	54,10 €	F2	9	6/90
NB1-2-40D	48,40 €	F3	5	6/90
NB1-2-40D10	49,40 €	F2	7	6/90
NB1-2-4B	31,20 €	F3	5	6/90
NB1-2-4B10	44,70 €	F2	7	6/90
NB1-2-4C	30,20 €	F1	5	6/90
NB1-2-4C10	42,30 €	F2	7	6/90
NB1-2-4CC47	50,60 €	F2	9	6/90
NB1-2-4CC715	51,70 €	F2	9	6/90
NB1-2-4D	44,80 €	F3	5	6/90
NB1-2-4D10	49,70 €	F2	7	6/90

Referencia	P.V.P.	Fam.	Pag.	Emb.
NB1-2-50B	54,40 €	F3	5	6/90
NB1-2-50B10	52,00 €	F2	7	6/90
NB1-2-50C	48,20 €	F1	5	6/90
NB1-2-50C10	49,70 €	F2	7	6/90
NB1-2-50CC47	89,40 €	F2	9	6/90
NB1-2-50CC715	94,00 €	F2	9	6/90
NB1-2-50D	59,50 €	F3	5	6/90
NB1-2-50D10	83,40 €	F2	7	6/90
NB1-2-63B	70,00 €	F3	5	6/90
NB1-2-63B10	69,70 €	F2	7	6/90
NB1-2-63C	59,90 €	F1	5	6/90
NB1-2-63C10	62,70 €	F2	7	6/90
NB1-2-63CC47	95,20 €	F2	9	6/90
NB1-2-63CC715	98,70 €	F2	9	6/90
NB1-2-63D	76,80 €	F3	5	6/90
NB1-2-63D10	86,20 €	F2	7	6/90
NB1-2-6B	29,40 €	F3	5	6/90
NB1-2-6B10	37,70 €	F2	7	6/90
NB1-2-6C	27,80 €	F1	5	6/90
NB1-2-6C10	36,50 €	F2	7	6/90
NB1-2-6CC47	40,00 €	F2	9	6/90
NB1-2-6CC715	41,20 €	F2	9	6/90
NB1-2-6D	36,40 €	F3	5	6/90
NB1-2-6D10	38,50 €	F2	7	6/90
NB1-3-10B	48,50 €	F3	6	4/60
NB1-3-10B10	57,70 €	F2	8	4/60
NB1-3-10C	44,40 €	F1	6	4/60
NB1-3-10C10	55,50 €	F2	8	4/60
NB1-3-10D	55,40 €	F3	6	4/60
NB1-3-10D10	57,70 €	F2	8	4/60
NB1-3-16B	48,50 €	F3	6	4/60
NB1-3-16B10	57,70 €	F2	8	4/60
NB1-3-16C	44,40 €	F1	6	4/60
NB1-3-16C10	55,50 €	F2	8	4/60
NB1-3-16D	55,40 €	F3	6	4/60
NB1-3-16D10	57,70 €	F2	8	4/60
NB1-3-1B	74,10 €	F3	6	4/60
NB1-3-1B10	83,40 €	F2	8	4/60
NB1-3-1C	70,70 €	F1	6	4/60
NB1-3-1C10	73,40 €	F2	8	4/60
NB1-3-1D	76,10 €	F3	6	4/60
NB1-3-1D10	89,40 €	F2	8	4/60
NB1-3-20B	48,50 €	F3	6	4/60
NB1-3-20B10	57,70 €	F2	8	4/60
NB1-3-20C	44,40 €	F1	6	4/60
NB1-3-20C10	55,50 €	F2	8	4/60
NB1-3-20D	55,40 €	F3	6	4/60
NB1-3-20D10	57,70 €	F2	8	4/60
NB1-3-25B	48,50 €	F3	6	4/60
NB1-3-25B10	57,70 €	F2	8	4/60
NB1-3-25C	44,40 €	F1	6	4/60
NB1-3-25C10	55,50 €	F2	8	4/60
NB1-3-25D	55,40 €	F3	6	4/60
NB1-3-25D10	57,70 €	F2	8	4/60
NB1-3-2B	74,10 €	F3	6	4/60
NB1-3-2B10	83,40 €	F2	8	4/60
NB1-3-2C	70,70 €	F1	6	4/60
NB1-3-2C10	73,40 €	F2	8	4/60
NB1-3-2D	76,10 €	F3	6	4/60
NB1-3-2D10	89,40 €	F2	8	4/60
NB1-3-32B	48,50 €	F3	6	4/60
NB1-3-32B10	57,70 €	F2	8	4/60
NB1-3-32C	44,40 €	F1	6	4/60
NB1-3-32C10	55,50 €	F2	8	4/60
NB1-3-32D	55,40 €	F3	6	4/60
NB1-3-32D10	57,70 €	F2	8	4/60
NB1-3-3B	74,10 €	F3	6	4/60
NB1-3-3B10	83,40 €	F2	8	4/60
NB1-3-3C	70,70 €	F1	6	4/60
NB1-3-3C10	73,40 €	F2	8	4/60

Referencia	P.V.P.	Fam.	Pag.	Emb.
NB1-3-3D	76,10 €	F3	6	4/60
NB1-3-3D10	89,40 €	F2	8	4/60
NB1-3-40B	62,60 €	F3	6	4/60
NB1-3-40B10	82,10 €	F2	8	4/60
NB1-3-40C	59,90 €	F1	6	4/60
NB1-3-40C10	71,70 €	F2	8	4/60
NB1-3-40D	71,40 €	F3	6	4/60
NB1-3-40D10	89,40 €	F2	8	4/60
NB1-3-4B	74,10 €	F3	6	4/60
NB1-3-4B10	83,40 €	F2	8	4/60
NB1-3-4C	70,70 €	F1	6	4/60
NB1-3-4C10	73,40 €	F2	8	4/60
NB1-3-4D	76,10 €	F3	6	4/60
NB1-3-4D10	89,40 €	F2	8	4/60
NB1-3-50B	82,50 €	F3	6	4/60
NB1-3-50B10	110,50 €	F2	8	4/60
NB1-3-50C	80,10 €	F1	6	4/60
NB1-3-50C10	100,00 €	F2	8	4/60
NB1-3-50D	93,60 €	F3	6	4/60
NB1-3-50D10	116,60 €	F2	8	4/60
NB1-3-63B	111,90 €	F3	6	4/60
NB1-3-63B10	130,40 €	F2	8	4/60
NB1-3-63C	104,80 €	F1	6	4/60
NB1-3-63C10	117,30 €	F2	8	4/60
NB1-3-63D	129,80 €	F3	6	4/60
NB1-3-63D10	148,00 €	F2	8	4/60
NB1-3-6B	48,50 €	F3	6	4/60
NB1-3-6B10	57,70 €	F2	8	4/60
NB1-3-6C	44,40 €	F1	6	4/60
NB1-3-6C10	55,50 €	F2	8	4/60
NB1-3-6D	55,40 €	F3	6	4/60
NB1-3-6D10	57,70 €	F2	8	4/60
NB1-4-10B	65,00 €	F3	6	3/45
NB1-4-10B10	74,10 €	F2	8	3/45
NB1-4-10C	58,90 €	F1	6	3/45
NB1-4-10C10	73,70 €	F2	8	3/45
NB1-4-10D	74,10 €	F3	6	3/45
NB1-4-10D10	76,50 €	F2	8	3/45
NB1-4-16B	65,00 €	F3	6	3/45
NB1-4-16B10	74,10 €	F2	8	3/45
NB1-4-16C	58,90 €	F1	6	3/45
NB1-4-16C10	73,70 €	F2	8	3/45
NB1-4-16D	74,10 €	F3	6	3/45
NB1-4-16D10	76,50 €	F2	8	3/45
NB1-4-1B	81,60 €	F3	6	3/45
NB1-4-1B10	110,00 €	F2	8	3/45
NB1-4-1C	77,80 €	F1	6	3/45
NB1-4-1C10	104,30 €	F2	8	3/45
NB1-4-1D	95,30 €	F3	6	3/45
NB1-4-1D10	111,80 €	F2	8	3/45
NB1-4-20B	65,00 €	F3	6	3/45
NB1-4-20B10	74,10 €	F2	8	3/45
NB1-4-20C	58,90 €	F1	6	3/45
NB1-4-20C10	73,70 €	F2	8	3/45
NB1-4-20D	74,10 €	F3	6	3/45
NB1-4-20D10	76,50 €	F2	8	3/45
NB1-4-25B	65,00 €	F3	6	3/45
NB1-4-25B10	74,10 €	F2	8	3/45
NB1-4-25C	58,90 €	F1	6	3/45
NB1-4-25C10	73,70 €	F2	8	3/45
NB1-4-25D	74,10 €	F3	6	3/45
NB1-4-25D10	76,50 €	F2	8	3/45
NB1-4-2B	81,60 €	F3	6	3/45
NB1-4-2B10	110,00 €	F2	8	3/45
NB1-4-2C	77,80 €	F1	6	3/45
NB1-4-2C10	104,30 €	F2	8	3/45
NB1-4-2D	95,30 €	F3	6	3/45
NB1-4-2D10	111,80 €	F2	8	3/45
NB1-4-32B	65,00 €	F3	6	3/45
NB1-4-32B10	74,10 €	F2	8	3/45

Referencia	P.V.P.	Fam.	Pag.	Emb.
NB1-4-32C	58,90 €	F1	6	3/45
NB1-4-32C10	73,70 €	F2	8	3/45
NB1-4-32D	74,10 €	F3	6	3/45
NB1-4-32D10	76,50 €	F2	8	3/45
NB1-4-3B	81,60 €	F3	6	3/45
NB1-4-3B10	110,00 €	F2	8	3/45
NB1-4-3C	77,80 €	F1	6	3/45
NB1-4-3C10	104,30 €	F2	8	3/45
NB1-4-3D	95,30 €	F3	6	3/45
NB1-4-3D10	111,80 €	F2	8	3/45
NB1-4-40B	83,70 €	F3	6	3/45
NB1-4-40B10	103,40 €	F2	8	3/45
NB1-4-40C	82,80 €	F1	6	3/45
NB1-4-40C10	95,30 €	F2	8	3/45
NB1-4-40D	95,40 €	F3	6	3/45
NB1-4-40D10	112,80 €	F2	8	3/45
NB1-4-4B	81,60 €	F3	6	3/45
NB1-4-4B10	110,00 €	F2	8	3/45
NB1-4-4C	77,80 €	F1	6	3/45
NB1-4-4C10	104,30 €	F2	8	3/45
NB1-4-4D	95,30 €	F3	6	3/45
NB1-4-4D10	111,80 €	F2	8	3/45
NB1-4-50B	125,80 €	F3	6	3/45
NB1-4-50B10	138,80 €	F2	8	3/45
NB1-4-50C	116,50 €	F1	6	3/45
NB1-4-50C10	127,30 €	F2	8	3/45
NB1-4-50D	143,50 €	F3	6	3/45
NB1-4-50D10	147,40 €	F2	8	3/45
NB1-4-63B	142,50 €	F3	6	3/45
NB1-4-63B10	155,30 €	F2	8	3/45
NB1-4-63C	129,50 €	F1	6	3/45
NB1-4-63C10	142,30 €	F2	8	3/45
NB1-4-63D	165,90 €	F3	6	3/45
NB1-4-63D10	177,20 €	F2	8	3/45
NB1-4-6B	65,00 €	F3	6	3/45
NB1-4-6B10	74,10 €	F2	8	3/45
NB1-4-6C	58,90 €	F1	6	3/45
NB1-4-6C10	73,70 €	F2	8	3/45
NB1-4-6D	74,10 €	F3	6	3/45
NB1-4-6D10	76,50 €	F2	8	3/45
NB1-ICP-1-10	14,10 €	F1	3	12/180
NB1-ICP-1-15	14,20 €	F1	3	12/180
NB1-ICP-1-20	14,60 €	F1	3	12/180
NB1-ICP-1-25	14,80 €	F1	3	12/180
NB1-ICP-1-3	33,50 €	F1	3	12/180
NB1-ICP-1-3,5	33,50 €	F1	3	12/180
NB1-ICP-1-30	19,20 €	F1	3	12/180
NB1-ICP-1-35	22,10 €	F1	3	12/180
NB1-ICP-1-40	24,90 €	F1	3	12/180
NB1-ICP-1-45	26,50 €	F1	3	12/180
NB1-ICP-1-5	18,50 €	F1	3	12/180
NB1-ICP-1-50	47,10 €	F1	3	12/180
NB1-ICP-1-63	49,90 €	F1	3	12/180
NB1-ICP-2-10	22,30 €	F1	3	6/90
NB1-ICP-2-15	22,80 €	F1	3	6/90
NB1-ICP-2-20	23,60 €	F1	3	6/90
NB1-ICP-2-25	25,20 €	F1	3	6/90
NB1-ICP-2-3	60,30 €	F1	3	6/90
NB1-ICP-2-3,5	60,30 €	F1	3	6/90
NB1-ICP-2-30	39,10 €	F1	3	6/90
NB1-ICP-2-35	47,50 €	F1	3	6/90
NB1-ICP-2-40	48,00 €	F1	3	6/90
NB1-ICP-2-45	58,70 €	F1	3	6/90
NB1-ICP-2-5	38,60 €	F1	3	6/90
NB1-ICP-2-50	78,20 €	F1	3	6/90
NB1-ICP-2-63	96,00 €	F1	3	6/90
NB1-ICP-3-10	53,00 €	F1	4	4/60
NB1-ICP-3-15	53,40 €	F1	4	4/60
NB1-ICP-3-20	54,80 €	F1	4	4/60
NB1-ICP-3-25	56,10 €	F1	4	4/60

Referencia	P.V.P.	Fam.	Pag.	Emb.
NB1-ICP-3-3	100,20 €	F1	4	4/60
NB1-ICP-3-3,5	100,20 €	F1	4	4/60
NB1-ICP-3-30	60,40 €	F1	4	4/60
NB1-ICP-3-35	75,50 €	F1	4	4/60
NB1-ICP-3-40	78,20 €	F1	4	4/60
NB1-ICP-3-45	80,70 €	F1	4	4/60
NB1-ICP-3-5	58,10 €	F1	4	4/60
NB1-ICP-3-50	128,30 €	F1	4	4/60
NB1-ICP-3-63	145,30 €	F1	4	4/60
NB1-ICP-4-10	80,80 €	F1	4	3/45
NB1-ICP-4-15	81,00 €	F1	4	3/45
NB1-ICP-4-20	81,50 €	F1	4	3/45
NB1-ICP-4-25	83,50 €	F1	4	3/45
NB1-ICP-4-3	150,30 €	F1	4	3/45
NB1-ICP-4-3,5	150,30 €	F1	4	3/45
NB1-ICP-4-30	88,10 €	F1	4	3/45
NB1-ICP-4-35	103,30 €	F1	4	3/45
NB1-ICP-4-40	106,30 €	F1	4	3/45
NB1-ICP-4-45	122,30 €	F1	4	3/45
NB1-ICP-4-5	83,80 €	F1	4	3/45
NB1-ICP-4-50	177,30 €	F1	4	3/45
NB1-ICP-4-63	183,30 €	F1	4	3/45
NB1L-1N-10C300A	102,25 €	F1	15	1/60
NB1L-1N-10C300A10	110,80 €	F1	17	1/60
NB1L-1N-10C300AC	88,50 €	F1	15	1/60
NB1L-1N-10C300AC10	99,10 €	F1	17	1/60
NB1L-1N-10C30A	101,20 €	F1	15	1/60
NB1L-1N-10C30A/2	87,40 €	F1	14	1
NB1L-1N-10C30A10	114,50 €	F1	17	1/60
NB1L-1N-10C30AC	93,20 €	F1	15	1/60
NB1L-1N-10C30AC10	102,50 €	F1	17	1/60
NB1L-1N-16C300A	93,50 €	F1	15	1/60
NB1L-1N-16C300A10	111,10 €	F1	17	1/60
NB1L-1N-16C300AC	89,00 €	F1	15	1/60
NB1L-1N-16C300AC10	99,40 €	F1	17	1/60
NB1L-1N-16C30A	107,90 €	F1	15	1/60
NB1L-1N-16C30A/2	87,80 €	F1	14	1
NB1L-1N-16C30A10	114,70 €	F1	17	1/60
NB1L-1N-16C30AC	93,70 €	F1	15	1/60
NB1L-1N-16C30AC10	102,70 €	F1	17	1/60
NB1L-1N-20C300A	103,20 €	F1	15	1/60
NB1L-1N-20C300A10	109,30 €	F1	17	1/60
NB1L-1N-20C300AC	90,65 €	F1	15	1/60
NB1L-1N-20C300AC10	101,20 €	F1	17	1/60
NB1L-1N-20C30A	108,90 €	F1	15	1/60
NB1L-1N-20C30A/2	90,30 €	F1	14	1
NB1L-1N-20C30A10	116,45 €	F1	17	1/60
NB1L-1N-20C30AC	95,40 €	F1	15	1/60
NB1L-1N-20C30AC10	104,40 €	F1	17	1/60
NB1L-1N-25C300A	105,30 €	F1	15	1/60
NB1L-1N-25C300A10	110,10 €	F1	17	1/60
NB1L-1N-25C300AC	91,50 €	F1	15	1/60
NB1L-1N-25C300AC10	103,30 €	F1	17	1/60
NB1L-1N-25C30A	111,20 €	F1	15	1/60
NB1L-1N-25C30A/2	90,70 €	F1	14	1
NB1L-1N-25C30A10	117,30 €	F1	17	1/60
NB1L-1N-25C30AC	96,70 €	F1	15	1/60
NB1L-1N-25C30AC10	105,80 €	F1	17	1/60
NB1L-1N-32C300A	108,30 €	F1	15	1/60
NB1L-1N-32C300A10	115,20 €	F1	17	1/60
NB1L-1N-32C300AC	93,60 €	F1	15	1/60
NB1L-1N-32C300AC10	106,10 €	F1	17	1/60
NB1L-1N-32C30A	112,90 €	F1	15	1/60
NB1L-1N-32C30A/2	92,30 €	F1	14	1
NB1L-1N-32C30A10	120,90 €	F1	17	1/60
NB1L-1N-32C30AC	99,10 €	F1	15	1/60
NB1L-1N-32C30AC10	108,30 €	F1	17	1/60
NB1L-1N-40C300A	110,35 €	F1	15	1/60
NB1L-1N-40C300A10	117,40 €	F1	17	1/60
NB1L-1N-40C300AC	95,90 €	F1	15	1/60

Referencia	P.V.P.	Fam.	Pag.	Emb.
NB1L-1N-40C300AC10	109,10 €	F1	17	1/60
NB1L-1N-40C30A	116,30 €	F1	15	1/60
NB1L-1N-40C30A/2	98,50 €	F1	14	1
NB1L-1N-40C30A10	123,15 €	F1	17	1/60
NB1L-1N-40C30AC	101,70 €	F1	15	1/60
NB1L-1N-40C30AC10	111,90 €	F1	17	1/60
NB1L-1N-50C300AC	113,05 €	F1	15	1/60
NB1L-1N-50C30AC	119,20 €	F1	15	1/60
NB1L-1N-63C300AC	125,50 €	F1	15	1/60
NB1L-1N-63C30AC	130,10 €	F1	15	1/60
NB1L-1N-6C300A	104,40 €	F1	15	1/60
NB1L-1N-6C300A10	108,60 €	F1	17	1/60
NB1L-1N-6C300AC	90,80 €	F1	15	1/60
NB1L-1N-6C300AC10	98,80 €	F1	17	1/60
NB1L-1N-6C30A	103,20 €	F1	15	1/60
NB1L-1N-6C30A/2	89,50 €	F1	14	1
NB1L-1N-6C30A10	116,20 €	F1	17	1/60
NB1L-1N-6C30AC	95,60 €	F1	15	1/60
NB1L-1N-6C30AC10	104,60 €	F1	17	1/60
NB1L-2-10C300A	107,20 €	F1	15	1/48
NB1L-2-10C300A10	118,40 €	F1	17	1/48
NB1L-2-10C300AC	93,20 €	F1	15	1/48
NB1L-2-10C300AC10	103,60 €	F1	17	1/48
NB1L-2-10C30A	112,70 €	F1	15	1/48
NB1L-2-10C30A10	125,30 €	F1	17	1/48
NB1L-2-10C30A10/3	100,40 €	F1	14	1
NB1L-2-10C30AC	98,00 €	F1	15	1/48
NB1L-2-10C30AC10	109,90 €	F1	17	1/48
NB1L-2-16C300A	107,90 €	F1	15	1/48
NB1L-2-16C300A10	119,60 €	F1	17	1/48
NB1L-2-16C300AC	93,60 €	F1	15	1/48
NB1L-2-16C300AC10	104,10 €	F1	17	1/48
NB1L-2-16C30A	113,20 €	F1	15	1/48
NB1L-2-16C30A10	126,10 €	F1	17	1/48
NB1L-2-16C30A10/3	100,90 €	F1	14	1
NB1L-2-16C30AC	98,50 €	F1	15	1/48
NB1L-2-16C30AC10	110,70 €	F1	17	1/48
NB1L-2-20C300A	109,70 €	F1	15	1/48
NB1L-2-20C300A10	121,90 €	F1	17	1/48
NB1L-2-20C300AC	95,40 €	F1	15	1/48
NB1L-2-20C300AC10	106,40 €	F1	17	1/48
NB1L-2-20C30A	115,10 €	F1	15	1/48
NB1L-2-20C30A10	128,80 €	F1	17	1/48
NB1L-2-20C30A10/3	102,60 €	F1	14	1
NB1L-2-20C30AC	100,40 €	F1	15	1/48
NB1L-2-20C30AC10	112,40 €	F1	17	1/48
NB1L-2-25C300A	110,40 €	F1	15	1/48
NB1L-2-25C300A10	124,20 €	F1	17	1/48
NB1L-2-25C300AC	95,95 €	F1	15	1/48
NB1L-2-25C300AC10	108,30 €	F1	17	1/48
NB1L-2-25C30A	116,90 €	F1	15	1/48
NB1L-2-25C30A10	132,50 €	F1	17	1/48
NB1L-2-25C30A10/3	103,90 €	F1	14	1
NB1L-2-25C30AC	101,70 €	F1	15	1/48
NB1L-2-25C30AC10	114,30 €	F1	17	1/48
NB1L-2-32C300A	113,60 €	F1	15	1/48
NB1L-2-32C300A10	128,80 €	F1	17	1/48
NB1L-2-32C300AC	98,80 €	F1	15	1/48
NB1L-2-32C300AC10	112,60 €	F1	17	1/48
NB1L-2-32C30A	119,80 €	F1	15	1/48
NB1L-2-32C30A10	135,70 €	F1	17	1/48
NB1L-2-32C30A10/3	106,30 €	F1	14	1
NB1L-2-32C30AC	104,20 €	F1	15	1/48
NB1L-2-32C30AC10	118,50 €	F1	17	1/48
NB1L-2-40C300A	116,80 €	F1	15	1/48
NB1L-2-40C300A10	134,30 €	F1	17	1/48
NB1L-2-40C300AC	101,65 €	F1	15	1/48
NB1L-2-40C300AC10	116,80 €	F1	17	1/48
NB1L-2-40C30A	123,00 €	F1	15	1/48
NB1L-2-40C30A10	141,40 €	F1	17	1/48

Referencia	P.V.P.	Fam.	Pag.	Emb.
NB1L-2-40C30A10/3	108,90 €	F1	14	1
NB1L-2-40C30AC	107,00 €	F1	15	1/48
NB1L-2-40C30AC10	123,40 €	F1	17	1/48
NB1L-2-50C300AC	114,90 €	F1	15	1/48
NB1L-2-50C30AC	120,10 €	F1	15	1/48
NB1L-2-63C300AC	124,40 €	F1	15	1/48
NB1L-2-63C30AC	131,25 €	F1	15	1/48
NB1L-2-6C300A	109,90 €	F1	15	1/48
NB1L-2-6C300A10	121,90 €	F1	17	1/48
NB1L-2-6C300AC	95,60 €	F1	15	1/48
NB1L-2-6C300AC10	106,80 €	F1	17	1/48
NB1L-2-6C30A	120,60 €	F1	15	1/48
NB1L-2-6C30A10	129,10 €	F1	17	1/48
NB1L-2-6C30A10/3	102,80 €	F1	14	1
NB1L-2-6C30AC	100,60 €	F1	15	1/48
NB1L-2-6C30AC10	112,20 €	F1	17	1/48
NB1L-3-10C300A	119,60 €	F1	16	1/24
NB1L-3-10C300A10	125,30 €	F1	18	1/24
NB1L-3-10C300AC	104,20 €	F1	16	1/24
NB1L-3-10C300AC10	109,10 €	F1	18	1/24
NB1L-3-10C30A	140,90 €	F1	16	1/24
NB1L-3-10C30A10	128,60 €	F1	18	1/24
NB1L-3-10C30AC	122,60 €	F1	16	1/24
NB1L-3-10C30AC10	112,20 €	F1	18	1/24
NB1L-3-16C300A	120,10 €	F1	16	1/24
NB1L-3-16C300A10	127,20 €	F1	18	1/24
NB1L-3-16C300AC	104,70 €	F1	16	1/24
NB1L-3-16C300AC10	109,80 €	F1	18	1/24
NB1L-3-16C30A	141,70 €	F1	16	1/24
NB1L-3-16C30A10	128,80 €	F1	18	1/24
NB1L-3-16C30AC	123,20 €	F1	16	1/24
NB1L-3-16C30AC10	112,90 €	F1	18	1/24
NB1L-3-20C300A	136,80 €	F1	16	1/24
NB1L-3-20C300A10	129,90 €	F1	18	1/24
NB1L-3-20C300AC	119,15 €	F1	16	1/24
NB1L-3-20C300AC10	111,60 €	F1	18	1/24
NB1L-3-20C30A	144,20 €	F1	16	1/24
NB1L-3-20C30A10	131,70 €	F1	18	1/24
NB1L-3-20C30AC	125,40 €	F1	16	1/24
NB1L-3-20C30AC10	114,30 €	F1	18	1/24
NB1L-3-25C300A	138,20 €	F1	16	1/24
NB1L-3-25C300A10	130,10 €	F1	18	1/24
NB1L-3-25C300AC	120,70 €	F1	16	1/24
NB1L-3-25C300AC10	113,80 €	F1	18	1/24
NB1L-3-25C30A	146,10 €	F1	16	1/24
NB1L-3-25C30A10	132,20 €	F1	18	1/24
NB1L-3-25C30AC	127,00 €	F1	16	1/24
NB1L-3-25C30AC10	115,50 €	F1	18	1/24
NB1L-3-32C300A	142,10 €	F1	16	1/24
NB1L-3-32C300A10	133,90 €	F1	18	1/24
NB1L-3-32C300AC	123,80 €	F1	16	1/24
NB1L-3-32C300AC10	115,60 €	F1	18	1/24
NB1L-3-32C30A	150,20 €	F1	16	1/24
NB1L-3-32C30A10	135,70 €	F1	18	1/24
NB1L-3-32C30AC	130,10 €	F1	16	1/24
NB1L-3-32C30AC10	118,80 €	F1	18	1/24
NB1L-3-40C300A	144,90 €	F1	16	1/24
NB1L-3-40C300A10	137,10 €	F1	18	1/24
NB1L-3-40C300AC	126,40 €	F1	16	1/24
NB1L-3-40C300AC10	119,30 €	F1	18	1/24
NB1L-3-40C30A	155,40 €	F1	16	1/24
NB1L-3-40C30A10	140,30 €	F1	18	1/24
NB1L-3-40C30AC	133,30 €	F1	16	1/24
NB1L-3-40C30AC10	122,10 €	F1	18	1/24
NB1L-3-50C300AC	134,80 €	F1	16	1/24
NB1L-3-50C30AC	142,10 €	F1	16	1/24
NB1L-3-63C300AC	145,20 €	F1	16	1/24
NB1L-3-63C30AC	152,80 €	F1	16	1/24
NB1L-3-6C300A	133,40 €	F1	16	1/24
NB1L-3-6C300A10	123,10 €	F1	18	1/24

Referencia	P.V.P.	Fam.	Pag.	Emb.
NB1L-3-6C300AC	116,50 €	F1	16	1/24
NB1L-3-6C300AC10	107,80 €	F1	18	1/24
NB1L-3-6C30A	144,55 €	F1	16	1/24
NB1L-3-6C30A10	131,80 €	F1	18	1/24
NB1L-3-6C30AC	125,70 €	F1	16	1/24
NB1L-3-6C30AC10	114,40 €	F1	18	1/24
NB1L-4-10C300A	157,30 €	F1	16	1/24
NB1L-4-10C300A10	149,50 €	F1	18	1/24
NB1L-4-10C300AC	136,80 €	F1	16	1/24
NB1L-4-10C300AC10	129,60 €	F1	18	1/24
NB1L-4-10C30A	165,60 €	F1	16	1/24
NB1L-4-10C30A10	154,90 €	F1	18	1/24
NB1L-4-10C30AC	144,40 €	F1	16	1/24
NB1L-4-10C30AC10	134,40 €	F1	18	1/24
NB1L-4-16C300A	158,60 €	F1	16	1/24
NB1L-4-16C300A10	151,30 €	F1	18	1/24
NB1L-4-16C300AC	137,60 €	F1	16	1/24
NB1L-4-16C300AC10	130,40 €	F1	18	1/24
NB1L-4-16C30A	165,90 €	F1	16	1/24
NB1L-4-16C30A10	155,10 €	F1	18	1/24
NB1L-4-16C30AC	144,90 €	F1	16	1/24
NB1L-4-16C30AC10	134,80 €	F1	18	1/24
NB1L-4-20C300A	161,10 €	F1	16	1/24
NB1L-4-20C300A10	152,10 €	F1	18	1/24
NB1L-4-20C300AC	140,00 €	F1	16	1/24
NB1L-4-20C300AC10	132,20 €	F1	18	1/24
NB1L-4-20C30A	169,10 €	F1	16	1/24
NB1L-4-20C30A10	156,80 €	F1	18	1/24
NB1L-4-20C30AC	147,70 €	F1	16	1/24
NB1L-4-20C30AC10	136,80 €	F1	18	1/24
NB1L-4-25C300A	163,20 €	F1	16	1/24
NB1L-4-25C300A10	154,20 €	F1	18	1/24
NB1L-4-25C300AC	141,95 €	F1	16	1/24
NB1L-4-25C300AC10	135,60 €	F1	18	1/24
NB1L-4-25C30A	171,40 €	F1	16	1/24
NB1L-4-25C30A10	158,70 €	F1	18	1/24
NB1L-4-25C30AC	149,40 €	F1	16	1/24
NB1L-4-25C30AC10	138,10 €	F1	18	1/24
NB1L-4-32C300A	167,30 €	F1	16	1/24
NB1L-4-32C300A10	158,20 €	F1	18	1/24
NB1L-4-32C300AC	145,40 €	F1	16	1/24
NB1L-4-32C300AC10	138,10 €	F1	18	1/24
NB1L-4-32C30A	176,10 €	F1	16	1/24
NB1L-4-32C30A10	162,60 €	F1	18	1/24
NB1L-4-32C30AC	153,10 €	F1	16	1/24
NB1L-4-32C30AC10	141,60 €	F1	18	1/24
NB1L-4-40C300A	171,35 €	F1	16	1/24
NB1L-4-40C300A10	165,60 €	F1	18	1/24
NB1L-4-40C300AC	149,20 €	F1	16	1/24
NB1L-4-40C300AC10	142,60 €	F1	18	1/24
NB1L-4-40C30A	180,70 €	F1	16	1/24
NB1L-4-40C30A10	167,90 €	F1	18	1/24
NB1L-4-40C30AC	157,10 €	F1	16	1/24
NB1L-4-40C30AC10	146,40 €	F1	18	1/24
NB1L-4-50C300AC	157,70 €	F1	16	1/24
NB1L-4-50C30AC	166,30 €	F1	16	1/24
NB1L-4-63C300AC	162,50 €	F1	16	1/24
NB1L-4-63C30AC	171,30 €	F1	16	1/24
NB1L-4-6C300A	160,60 €	F1	16	1/24
NB1L-4-6C300A10	151,20 €	F1	18	1/24
NB1L-4-6C300AC	139,65 €	F1	16	1/24
NB1L-4-6C300AC10	130,80 €	F1	18	1/24
NB1L-4-6C30A	170,10 €	F1	16	1/24
NB1L-4-6C30A10	156,40 €	F1	18	1/24
NB1L-4-6C30AC	147,90 €	F1	16	1/24
NB1L-4-6C30AC10	136,80 €	F1	18	1/24
NBH8-1N-10C	24,60 €	F1	1	12/120
NBH8-1N-16C	24,60 €	F1	1	12/120
NBH8-1N-20C	24,60 €	F1	1	12/120
NBH8-1N-25C	24,60 €	F1	1	12/120

Referencia	P.V.P.	Fam.	Pag.	Emb.
NBH8- 1N- 32C	26,10 €	F1	1	12/120
NBH8- 1N- 40C	26,10 €	F1	1	12/120
NBH8- 1N- 6C	24,60 €	F1	1	12/120
NC1-3- 12- 01- 110	25,70 €	F1	49	1
NC1-3- 12- 01- 230	25,70 €	F1	49	1
NC1-3- 12- 01- 24	25,70 €	F1	49	1
NC1-3- 12- 01- 400	25,70 €	F1	49	1
NC1-3- 12- 01- 48	25,70 €	F1	49	1
NC1-3- 12- 10- 110	25,70 €	F1	49	1
NC1-3- 12- 10- 230	25,70 €	F1	49	1
NC1-3- 12- 10- 24	25,70 €	F1	49	1
NC1-3- 12- 10- 400	25,70 €	F1	49	1
NC1-3- 12- 10- 48	25,70 €	F1	49	1
NC1-312NI- 110	83,60 €	F2	57	1
NC1-312NI- 230	83,60 €	F2	57	1
NC1-312NI- 24	83,60 €	F2	57	1
NC1-312NI- 400	83,60 €	F2	57	1
NC1-312NI- 48	83,60 €	F2	57	1
NC1-3- 12Z- 01- 110	57,90 €	F1	50	1
NC1-3- 12Z- 01- 220	57,90 €	F1	50	1
NC1-3- 12Z- 01- 24	57,90 €	F1	50	1
NC1-3- 12Z- 01- 48	57,90 €	F1	50	1
NC1-3- 12Z- 10- 110	57,90 €	F1	50	1
NC1-3- 12Z- 10- 220	57,90 €	F1	50	1
NC1-3- 12Z- 10- 24	57,90 €	F1	50	1
NC1-3- 12Z- 10- 48	57,90 €	F1	50	1
NC1-3- 18- 01- 110	34,30 €	F1	49	1
NC1-3- 18- 01- 230	34,30 €	F1	49	1
NC1-3- 18- 01- 24	34,30 €	F1	49	1
NC1-3- 18- 01- 400	34,30 €	F1	49	1
NC1-3- 18- 01- 48	34,30 €	F1	49	1
NC1-3- 18- 10- 110	34,30 €	F1	49	1
NC1-3- 18- 10- 230	34,30 €	F1	49	1
NC1-3- 18- 10- 24	34,30 €	F1	49	1
NC1-3- 18- 10- 400	34,30 €	F1	49	1
NC1-3- 18- 10- 48	34,30 €	F1	49	1
NC1-318NI- 110	113,70 €	F2	57	1
NC1-318NI- 230	113,70 €	F2	57	1
NC1-318NI- 24	113,70 €	F2	57	1
NC1-318NI- 400	113,70 €	F2	57	1
NC1-318NI- 48	113,70 €	F2	57	1
NC1-3- 18Z- 01- 110	84,60 €	F1	50	1
NC1-3- 18Z- 01- 220	84,60 €	F1	50	1
NC1-3- 18Z- 01- 24	84,60 €	F1	50	1
NC1-3- 18Z- 01- 48	84,60 €	F1	50	1
NC1-3- 18Z- 10- 110	84,60 €	F1	50	1
NC1-3- 18Z- 10- 220	84,60 €	F1	50	1
NC1-3- 18Z- 10- 24	84,60 €	F1	50	1
NC1-3- 18Z- 10- 48	84,60 €	F1	50	1
NC1-3- 25- 01- 110	52,30 €	F1	49	1
NC1-3- 25- 01- 230	52,30 €	F1	49	1
NC1-3- 25- 01- 24	52,30 €	F1	49	1
NC1-3- 25- 01- 400	52,30 €	F1	49	1
NC1-3- 25- 01- 48	52,30 €	F1	49	1
NC1-3- 25- 10- 110	52,30 €	F1	49	1
NC1-3- 25- 10- 230	52,30 €	F1	49	1
NC1-3- 25- 10- 24	52,30 €	F1	49	1
NC1-3- 25- 10- 400	52,30 €	F1	49	1
NC1-3- 25- 10- 48	52,30 €	F1	49	1
NC1-325NI- 110	131,30 €	F2	57	1
NC1-325NI- 230	131,30 €	F2	57	1
NC1-325NI- 24	131,30 €	F2	57	1
NC1-325NI- 248	131,30 €	F2	57	1
NC1-325NI- 400	131,30 €	F2	57	1
NC1-3- 25Z- 01- 110	108,50 €	F1	50	1
NC1-3- 25Z- 01- 220	108,50 €	F1	50	1
NC1-3- 25Z- 01- 24	108,50 €	F1	50	1
NC1-3- 25Z- 01- 48	108,50 €	F1	50	1
NC1-3- 25Z- 10- 110	108,50 €	F1	50	1
NC1-3- 25Z- 10- 220	108,50 €	F1	50	1

Referencia	P.V.P.	Fam.	Pag.	Emb.
NC1-3- 25Z- 10- 24	108,50 €	F1	50	1
NC1-3- 25Z- 10- 48	108,50 €	F1	50	1
NC1-3- 32- 01- 110	73,60 €	F1	49	1
NC1-3- 32- 01- 230	73,60 €	F1	49	1
NC1-3- 32- 01- 24	73,60 €	F1	49	1
NC1-3- 32- 01- 400	73,60 €	F1	49	1
NC1-3- 32- 01- 48	73,60 €	F1	49	1
NC1-3- 32- 10- 110	73,60 €	F1	49	1
NC1-3- 32- 10- 230	73,60 €	F1	49	1
NC1-3- 32- 10- 24	73,60 €	F1	49	1
NC1-3- 32- 10- 400	73,60 €	F1	49	1
NC1-3- 32- 10- 48	73,60 €	F1	49	1
NC1-332NI- 110	180,80 €	F2	57	1
NC1-332NI- 230	180,80 €	F2	57	1
NC1-332NI- 24	180,80 €	F2	57	1
NC1-332NI- 400	180,80 €	F2	57	1
NC1-332NI- 48	180,80 €	F2	57	1
NC1-3- 32Z- 01- 110	136,30 €	F1	50	1
NC1-3- 32Z- 01- 220	136,30 €	F1	50	1
NC1-3- 32Z- 01- 24	136,30 €	F1	50	1
NC1-3- 32Z- 01- 48	136,30 €	F1	50	1
NC1-3- 32Z- 10- 110	136,30 €	F1	50	1
NC1-3- 32Z- 10- 220	136,30 €	F1	50	1
NC1-3- 32Z- 10- 24	136,30 €	F1	50	1
NC1-3- 32Z- 10- 48	136,30 €	F1	50	1
NC1-3- 40- 11- 110	81,10 €	F1	49	1
NC1-3- 40- 11- 230	81,10 €	F1	49	1
NC1-3- 40- 11- 24	81,10 €	F1	49	1
NC1-3- 40- 11- 400	81,10 €	F1	49	1
NC1-3- 40- 11- 48	81,10 €	F1	49	1
NC1-340NI- 110	240,10 €	F2	57	1
NC1-340NI- 230	240,10 €	F2	57	1
NC1-340NI- 24	240,10 €	F2	57	1
NC1-340NI- 400	240,10 €	F2	57	1
NC1-340NI- 48	240,10 €	F2	57	1
NC1-3- 40Z- 11- 110	178,50 €	F1	50	1
NC1-3- 40Z- 11- 220	178,50 €	F1	50	1
NC1-3- 40Z- 11- 24	178,50 €	F1	50	1
NC1-3- 40Z- 11- 48	178,50 €	F1	50	1
NC1-3- 50- 11- 110	113,80 €	F1	49	1
NC1-3- 50- 11- 230	113,80 €	F1	49	1
NC1-3- 50- 11- 24	113,80 €	F1	49	1
NC1-3- 50- 11- 400	113,80 €	F1	49	1
NC1-3- 50- 11- 48	113,80 €	F1	49	1
NC1-350NI- 110	301,30 €	F2	57	1
NC1-350NI- 230	301,30 €	F2	57	1
NC1-350NI- 24	301,30 €	F2	57	1
NC1-350NI- 400	301,30 €	F2	57	1
NC1-350NI- 48	301,30 €	F2	57	1
NC1-3- 50Z- 11- 110	202,90 €	F1	50	1
NC1-3- 50Z- 11- 220	202,90 €	F1	50	1
NC1-3- 50Z- 11- 24	202,90 €	F1	50	1
NC1-3- 50Z- 11- 48	202,90 €	F1	50	1
NC1-3- 65- 11- 110	145,70 €	F1	49	1
NC1-3- 65- 11- 230	145,70 €	F1	49	1
NC1-3- 65- 11- 24	145,70 €	F1	49	1
NC1-3- 65- 11- 400	145,70 €	F1	49	1
NC1-3- 65- 11- 48	145,70 €	F1	49	1
NC1-365NI- 110	395,80 €	F2	57	1
NC1-365NI- 230	395,80 €	F2	57	1
NC1-365NI- 24	395,80 €	F2	57	1
NC1-365NI- 400	395,80 €	F2	57	1
NC1-365NI- 48	395,80 €	F2	57	1
NC1-3- 65Z- 11- 110	242,90 €	F1	50	1
NC1-3- 65Z- 11- 220	242,90 €	F1	50	1
NC1-3- 65Z- 11- 24	242,90 €	F1	50	1
NC1-3- 65Z- 11- 48	242,90 €	F1	50	1
NC1-3- 80- 11- 110	187,20 €	F1	49	1
NC1-3- 80- 11- 230	187,20 €	F1	49	1
NC1-3- 80- 11- 24	187,20 €	F1	49	1

Referencia	P.V.P.	Fam.	Pag.	Emb.
NC1-3-80-11-400	187,20 €	F1	49	1
NC1-3-80-11-48	187,20 €	F1	49	1
NC1-380NI-110	493,70 €	F2	57	1
NC1-380NI-230	493,70 €	F2	57	1
NC1-380NI-24	493,70 €	F2	57	1
NC1-380NI-400	493,70 €	F2	57	1
NC1-380NI-48	493,70 €	F2	57	1
NC1-3-80Z-11-110	325,10 €	F1	50	1
NC1-3-80Z-11-220	325,10 €	F1	50	1
NC1-3-80Z-11-24	325,10 €	F1	50	1
NC1-3-80Z-11-48	325,10 €	F1	50	1
NC1-3-95-11-110	210,60 €	F1	49	1
NC1-3-95-11-230	210,60 €	F1	49	1
NC1-3-95-11-24	210,60 €	F1	49	1
NC1-3-95-11-400	210,60 €	F1	49	1
NC1-3-95-11-48	210,60 €	F1	49	1
NC1-395NI-110	503,20 €	F2	57	1
NC1-395NI-230	503,20 €	F2	57	1
NC1-395NI-24	503,20 €	F2	57	1
NC1-395NI-400	503,20 €	F2	57	1
NC1-395NI-48	503,20 €	F2	57	1
NC1-3-95Z-11-110	372,90 €	F1	50	1
NC1-3-95Z-11-220	372,90 €	F1	50	1
NC1-3-95Z-11-24	372,90 €	F1	50	1
NC1-3-95Z-11-48	372,90 €	F1	50	1
NC1-4-12-00-110	27,90 €	F1	49	1
NC1-4-12-00-230	27,90 €	F1	49	1
NC1-4-12-00-24	27,90 €	F1	49	1
NC1-4-12-00-400	27,90 €	F1	49	1
NC1-4-12-00-48	27,90 €	F1	49	1
NC1-412NC-110	97,30 €	F2	57	1
NC1-412NC-230	97,30 €	F2	57	1
NC1-412NC-24	97,30 €	F2	57	1
NC1-412NC-400	97,30 €	F2	57	1
NC1-412NC-48	97,30 €	F2	57	1
NC1-4-25-00-110	35,35 €	F1	49	1
NC1-4-25-00-230	35,35 €	F1	49	1
NC1-4-25-00-24	35,35 €	F1	49	1
NC1-4-25-00-400	35,35 €	F1	49	1
NC1-4-25-00-48	35,35 €	F1	49	1
NC1-425NC-110	150,80 €	F2	57	1
NC1-425NC-230	150,80 €	F2	57	1
NC1-425NC-24	150,80 €	F2	57	1
NC1-425NC-400	150,80 €	F2	57	1
NC1-425NC-48	150,80 €	F2	57	1
NC1-4-40-00-110	96,00 €	F1	49	1
NC1-4-40-00-230	96,00 €	F1	49	1
NC1-4-40-00-24	96,00 €	F1	49	1
NC1-4-40-00-400	96,00 €	F1	49	1
NC1-4-40-00-48	96,00 €	F1	49	1
NC1-440NC-110	311,30 €	F2	57	1
NC1-440NC-230	311,30 €	F2	57	1
NC1-440NC-24	311,30 €	F2	57	1
NC1-440NC-400	311,30 €	F2	57	1
NC1-440NC-48	311,30 €	F2	57	1
NC1-4-50-00-110	168,00 €	F1	49	1
NC1-4-50-00-230	168,00 €	F1	49	1
NC1-4-50-00-24	168,00 €	F1	49	1
NC1-4-50-00-400	168,00 €	F1	49	1
NC1-4-50-00-48	168,00 €	F1	49	1
NC1-450NC-110	361,20 €	F2	57	1
NC1-450NC-230	361,20 €	F2	57	1
NC1-450NC-24	361,20 €	F2	57	1
NC1-450NC-400	361,20 €	F2	57	1
NC1-450NC-48	361,20 €	F2	57	1
NC1-4-65-00-110	192,50 €	F1	49	1
NC1-4-65-00-230	192,50 €	F1	49	1
NC1-4-65-00-24	192,50 €	F1	49	1
NC1-4-65-00-400	192,50 €	F1	49	1
NC1-4-65-00-48	192,50 €	F1	49	1

Referencia	P.V.P.	Fam.	Pag.	Emb.
NC1-465NC-110	482,60 €	F2	57	1
NC1-465NC-230	482,60 €	F2	57	1
NC1-465NC-24	482,60 €	F2	57	1
NC1-465NC-400	482,60 €	F2	57	1
NC1-465NC-48	482,60 €	F2	57	1
NC1-4-80-00-110	214,90 €	F1	49	1
NC1-4-80-00-230	214,90 €	F1	49	1
NC1-4-80-00-24	214,90 €	F1	49	1
NC1-4-80-00-400	214,90 €	F1	49	1
NC1-4-80-00-48	214,90 €	F1	49	1
NC1-480NC-110	619,30 €	F2	57	1
NC1-480NC-230	619,30 €	F2	57	1
NC1-480NC-24	619,30 €	F2	57	1
NC1-480NC-400	619,30 €	F2	57	1
NC1-480NC-48	619,30 €	F2	57	1
NC1-4-95-00-110	237,20 €	F1	49	1
NC1-4-95-00-230	237,20 €	F1	49	1
NC1-4-95-00-24	237,20 €	F1	49	1
NC1-4-95-00-400	237,20 €	F1	49	1
NC1-4-95-00-48	237,20 €	F1	49	1
NC1-495NC-110	743,80 €	F2	57	1
NC1-495NC-230	743,80 €	F2	57	1
NC1-495NC-24	743,80 €	F2	57	1
NC1-495NC-400	743,80 €	F2	57	1
NC1-495NC-48	743,80 €	F2	57	1
NC1-8-12-00-110	27,90 €	F1	49	1
NC1-8-12-00-230	27,90 €	F1	49	1
NC1-8-12-00-24	27,90 €	F1	49	1
NC1-8-12-00-400	27,90 €	F1	49	1
NC1-8-12-00-48	27,90 €	F1	49	1
NC1-8-25-00-110	35,35 €	F1	49	1
NC1-8-25-00-230	35,35 €	F1	49	1
NC1-8-25-00-24	35,35 €	F1	49	1
NC1-8-25-00-400	35,35 €	F1	49	1
NC1-8-25-00-48	35,35 €	F1	49	1
NC1-8-40-00-110	96,00 €	F1	49	1
NC1-8-40-00-230	96,00 €	F1	49	1
NC1-8-40-00-24	96,00 €	F1	49	1
NC1-8-40-00-400	96,00 €	F1	49	1
NC1-8-40-00-48	96,00 €	F1	49	1
NC1-8-50-00-110	168,00 €	F1	49	1
NC1-8-50-00-230	168,00 €	F1	49	1
NC1-8-50-00-24	168,00 €	F1	49	1
NC1-8-50-00-400	168,00 €	F1	49	1
NC1-8-50-00-48	168,00 €	F1	49	1
NC1-8-65-00-110	192,50 €	F1	49	1
NC1-8-65-00-230	192,50 €	F1	49	1
NC1-8-65-00-24	192,50 €	F1	49	1
NC1-8-65-00-400	192,50 €	F1	49	1
NC1-8-65-00-48	192,50 €	F1	49	1
NC1-8-80-00-110	214,90 €	F1	49	1
NC1-8-80-00-230	214,90 €	F1	49	1
NC1-8-80-00-24	214,90 €	F1	49	1
NC1-8-80-00-400	214,90 €	F1	49	1
NC1-8-80-00-48	214,90 €	F1	49	1
NC1-8-95-00-110	237,20 €	F1	49	1
NC1-8-95-00-230	237,20 €	F1	49	1
NC1-8-95-00-24	237,20 €	F1	49	1
NC1-8-95-00-400	237,20 €	F1	49	1
NC1-8-95-00-48	237,20 €	F1	49	1
NC2-3-115-00-110	200,00 €	F2	50	1
NC2-3-115-00-230	200,00 €	F2	50	1
NC2-3-115-00-400	200,00 €	F2	50	1
NC2-3115NI-110	524,30 €	F2	58	1
NC2-3115NI-230	524,30 €	F2	58	1
NC2-3115NI-400	524,30 €	F2	58	1
NC2-3-150-00-110	252,10 €	F2	50	1
NC2-3-150-00-230	252,10 €	F2	50	1
NC2-3-150-00-400	252,10 €	F2	50	1
NC2-3150NI-110	616,90 €	F2	58	1

Referencia	P.V.P.	Fam.	Pag.	Emb.
NC2-3150NI-230	616,90 €	F2	58	1
NC2-3150NI-400	616,90 €	F2	58	1
NC2-3-185-00-110	348,90 €	F2	50	1
NC2-3-185-00-230	348,90 €	F2	50	1
NC2-3-185-00-400	348,90 €	F2	50	1
NC2-3185NI-110	834,80 €	F2	58	1
NC2-3185NI-230	834,80 €	F2	58	1
NC2-3185NI-400	834,80 €	F2	58	1
NC2-3-225-00-110	379,80 €	F2	50	1
NC2-3-225-00-230	379,80 €	F2	50	1
NC2-3-225-00-400	379,80 €	F2	50	1
NC2-3225NI-110	906,40 €	F2	58	1
NC2-3225NI-230	906,40 €	F2	58	1
NC2-3225NI-400	906,40 €	F2	58	1
NC2-3-265-00-110	401,00 €	F2	50	1
NC2-3-265-00-230	401,00 €	F2	50	1
NC2-3-265-00-400	401,00 €	F2	50	1
NC2-3265NI-110	964,30 €	F2	58	1
NC2-3265NI-230	964,30 €	F2	58	1
NC2-3265NI-400	964,30 €	F2	58	1
NC2-3-330-00-110	625,50 €	F2	50	1
NC2-3-330-00-230	625,50 €	F2	50	1
NC2-3-330-00-400	625,50 €	F2	50	1
NC2-3330NI-110	1.451,60 €	F2	58	1
NC2-3330NI-230	1.451,60 €	F2	58	1
NC2-3330NI-400	1.451,60 €	F2	58	1
NC2-3-400-00-110	742,60 €	F2	50	1
NC2-3-400-00-230	742,60 €	F2	50	1
NC2-3-400-00-400	742,60 €	F2	50	1
NC2-3400NI-110	1.693,70 €	F2	58	1
NC2-3400NI-230	1.693,70 €	F2	58	1
NC2-3400NI-400	1.693,70 €	F2	58	1
NC2-3-500-00-110	854,20 €	F2	50	1
NC2-3-500-00-230	854,20 €	F2	50	1
NC2-3-500-00-400	854,20 €	F2	50	1
NC2-3500NI-110	1.904,20 €	F2	58	1
NC2-3500NI-230	1.904,20 €	F2	58	1
NC2-3500NI-400	1.904,20 €	F2	58	1
NC2-3-630-00-110	960,60 €	F2	50	1
NC2-3-630-00-230	960,60 €	F2	50	1
NC2-3-630-00-400	960,60 €	F2	50	1
NC2-3630NI-110	2.123,10 €	F2	58	1
NC2-3630NI-230	2.123,10 €	F2	58	1
NC2-3630NI-400	2.123,10 €	F2	58	1
NC2-4-115-00-110	271,20 €	F2	50	1
NC2-4-115-00-230	271,20 €	F2	50	1
NC2-4-115-00-400	271,20 €	F2	50	1
NC2-4115NC-110	884,50 €	F2	58	1
NC2-4115NC-230	884,50 €	F2	58	1
NC2-4115NC-400	884,50 €	F2	58	1
NC2-4-150-00-110	325,50 €	F2	50	1
NC2-4-150-00-230	325,50 €	F2	50	1
NC2-4-150-00-400	325,50 €	F2	50	1
NC2-4150NC-110	945,30 €	F2	58	1
NC2-4150NC-230	945,30 €	F2	58	1
NC2-4150NC-400	945,30 €	F2	58	1
NC2-4-185-00-110	390,40 €	F2	50	1
NC2-4-185-00-230	390,40 €	F2	50	1
NC2-4-185-00-400	390,40 €	F2	50	1
NC2-4185NC-110	1.000,00 €	F2	58	1
NC2-4185NC-230	1.000,00 €	F2	58	1
NC2-4185NC-400	1.000,00 €	F2	58	1
NC2-4-225-00-110	417,00 €	F2	50	1
NC2-4-225-00-230	417,00 €	F2	50	1
NC2-4-225-00-400	417,00 €	F2	50	1
NC2-4225NC-110	1.156,80 €	F2	58	1
NC2-4225NC-230	1.156,80 €	F2	58	1
NC2-4225NC-400	1.156,80 €	F2	58	1
NC2-4-265-00-110	444,60 €	F2	50	1
NC2-4-265-00-230	444,60 €	F2	50	1

Referencia	P.V.P.	Fam.	Pag.	Emb.
NC2-4-265-00-400	444,60 €	F2	50	1
NC2-4265NC-110	1.220,00 €	F2	58	1
NC2-4265NC-230	1.220,00 €	F2	58	1
NC2-4265NC-400	1.220,00 €	F2	58	1
NC2-4-330-00-110	689,30 €	F2	50	1
NC2-4-330-00-230	689,30 €	F2	50	1
NC2-4-330-00-400	689,30 €	F2	50	1
NC2-4330NC-110	1.714,70 €	F2	58	1
NC2-4330NC-230	1.714,70 €	F2	58	1
NC2-4330NC-400	1.714,70 €	F2	58	1
NC2-4-400-00-110	848,90 €	F2	50	1
NC2-4-400-00-230	848,90 €	F2	50	1
NC2-4-400-00-400	848,90 €	F2	50	1
NC2-4400NC-110	2.041,00 €	F2	58	1
NC2-4400NC-230	2.041,00 €	F2	58	1
NC2-4400NC-400	2.041,00 €	F2	58	1
NC2-4-500-00-110	953,30 €	F2	50	1
NC2-4-500-00-230	953,30 €	F2	50	1
NC2-4-500-00-400	953,30 €	F2	50	1
NC2-4500NC-110	2.228,40 €	F2	58	1
NC2-4500NC-230	2.228,40 €	F2	58	1
NC2-4500NC-400	2.228,40 €	F2	58	1
NC2-4-630-00-110	1.008,20 €	F2	50	1
NC2-4-630-00-230	1.008,20 €	F2	50	1
NC2-4-630-00-400	1.008,20 €	F2	50	1
NC2-4630NC-110	2.504,20 €	F2	58	1
NC2-4630NC-230	2.504,20 €	F2	58	1
NC2-4630NC-400	2.504,20 €	F2	58	1
NC6-3-9-01-110	19,20 €	F1	49	1/100
NC6-3-9-01-230	19,20 €	F1	49	1/100
NC6-3-9-01-24	19,20 €	F1	49	1/100
NC6-3-9-01-400	19,20 €	F1	49	1/100
NC6-3-9-01-48	19,20 €	F1	49	1/100
NC6-3-9-10-110	19,20 €	F1	49	1/100
NC6-3-9-10-230	19,20 €	F1	49	1/100
NC6-3-9-10-24	19,20 €	F1	49	1/100
NC6-3-9-10-400	19,20 €	F1	49	1/100
NC6-3-9-10-48	19,20 €	F1	49	1/100
NC6-4-9-00-110	19,60 €	F1	49	1/100
NC6-4-9-00-230	19,60 €	F1	49	1/100
NC6-4-9-00-24	19,60 €	F1	49	1/100
NC6-4-9-00-400	19,60 €	F1	49	1/100
NC6-4-9-00-48	19,60 €	F1	49	1/100
NC6-K-3-9-01-110	19,20 €	F1	49	1/100
NC6-K-3-9-01-230	19,20 €	F1	49	1/100
NC6-K-3-9-01-24	19,20 €	F1	49	1/100
NC6-K-3-9-01-400	19,20 €	F1	49	1/100
NC6-K-3-9-01-48	19,20 €	F1	49	1/100
NC6-K-3-9-10-110	19,20 €	F1	49	1/100
NC6-K-3-9-10-230	19,20 €	F1	49	1/100
NC6-K-3-9-10-24	19,20 €	F1	49	1/100
NC6-K-3-9-10-400	19,20 €	F1	49	1/100
NC6-K-3-9-10-48	19,20 €	F1	49	1/100
NC6-K-4-9-00-110	19,60 €	F1	49	1/100
NC6-K-4-9-00-230	19,60 €	F1	49	1/100
NC6-K-4-9-00-24	19,60 €	F1	49	1/100
NC6-K-4-9-00-400	19,60 €	F1	49	1/100
NC6-K-4-9-00-48	19,60 €	F1	49	1/100
NC9-22	- €	F5	52	1
NC9-3-1000-110	- €	F5	52	1
NC9-3-1000-230	- €	F5	52	1
NC9-3-1000-400	- €	F5	52	1
NC9-3-160-110	- €	F5	52	1
NC9-3-160-230	- €	F5	52	1
NC9-3-160-400	- €	F5	52	1
NC9-3-250-110	- €	F5	52	1
NC9-3-250-230	- €	F5	52	1
NC9-3-250-400	- €	F5	52	1
NC9-3-400-110	- €	F5	52	1
NC9-3-400-230	- €	F5	52	1

Referencia	P.V.P.	Fam.	Pag.	Emb.
NC9-3-400-400	- €	F5	52	1
NC9-3-630-110	- €	F5	52	1
NC9-3-630-230	- €	F5	52	1
NC9-3-630-400	- €	F5	52	1
NC9-3-800-110	- €	F5	52	1
NC9-3-800-230	- €	F5	52	1
NC9-3-800-400	- €	F5	52	1
NC9-44	- €	F5	52	1
NCF1-11	8,60 €	F2	52	6
NCH8-20/02-230	28,80 €	F1	27	12/180
NCH8-20/02-24	28,80 €	F1	27	12/180
NCH8-20/11-230	28,80 €	F1	27	12/180
NCH8-20/11-24	28,80 €	F1	27	12/180
NCH8-20/20-230	28,80 €	F1	27	12/180
NCH8-20/20-24	28,80 €	F1	27	12/180
NCH8-20/22-230	35,30 €	F1	27	6/90
NCH8-20/22-24	35,30 €	F1	27	6/90
NCH8-20/40-230	35,30 €	F1	27	6/90
NCH8-20/40-24	35,30 €	F1	27	6/90
NCH8-25/22-230	47,10 €	F1	27	6/90
NCH8-25/22-24	47,10 €	F1	27	6/90
NCH8-25/40-230	47,10 €	F1	27	6/90
NCH8-25/40-24	47,10 €	F1	27	6/90
NCH8-40/11-230	59,50 €	F1	27	6/90
NCH8-40/11-24	59,50 €	F1	27	6/90
NCH8-40/20-230	59,50 €	F1	27	6/90
NCH8-40/20-24	59,50 €	F1	27	6/90
NCH8-40/40-230	75,20 €	F1	27	4/60
NCH8-40/40-24	75,20 €	F1	27	4/60
NCH8-63/11-230	89,70 €	F1	27	6/90
NCH8-63/11-24	89,70 €	F1	27	6/90
NCH8-63/20-230	89,70 €	F1	27	6/90
NCH8-63/20-24	89,70 €	F1	27	6/90
NCH8-63/40-230	101,90 €	F1	27	4/60
NCH8-63/40-24	101,90 €	F1	27	4/60
ND16-22A/2/B/110	5,90 €	F1	70	10
ND16-22A/2/B/12	5,90 €	F1	70	10
ND16-22A/2/B/230	5,90 €	F1	70	10
ND16-22A/2/B/24	5,90 €	F1	70	10
ND16-22A/2/B/36	5,90 €	F1	70	10
ND16-22A/2/B/400	5,90 €	F1	70	10
ND16-22A/2/B/48	5,90 €	F1	70	10
ND16-22A/2/B/6	5,90 €	F1	70	10
ND16-22A/2/G/110	5,90 €	F1	70	10
ND16-22A/2/G/12	5,90 €	F1	70	10
ND16-22A/2/G/230	5,90 €	F1	70	10
ND16-22A/2/G/24	5,90 €	F1	70	10
ND16-22A/2/G/36	5,90 €	F1	70	10
ND16-22A/2/G/400	5,90 €	F1	70	10
ND16-22A/2/G/48	5,90 €	F1	70	10
ND16-22A/2/G/6	5,90 €	F1	70	10
ND16-22A/2/R/110	5,90 €	F1	70	10
ND16-22A/2/R/12	5,90 €	F1	70	10
ND16-22A/2/R/230	5,90 €	F1	70	10
ND16-22A/2/R/24	5,90 €	F1	70	10
ND16-22A/2/R/36	5,90 €	F1	70	10
ND16-22A/2/R/400	5,90 €	F1	70	10
ND16-22A/2/R/48	5,90 €	F1	70	10
ND16-22A/2/R/6	5,90 €	F1	70	10
ND16-22A/2/W/110	5,90 €	F1	70	10
ND16-22A/2/W/12	5,90 €	F1	70	10
ND16-22A/2/W/230	5,90 €	F1	70	10
ND16-22A/2/W/24	5,90 €	F1	70	10
ND16-22A/2/W/36	5,90 €	F1	70	10
ND16-22A/2/W/400	5,90 €	F1	70	10
ND16-22A/2/W/48	5,90 €	F1	70	10
ND16-22A/2/W/6	5,90 €	F1	70	10
ND16-22A/2/Y/110	5,90 €	F1	70	10
ND16-22A/2/Y/12	5,90 €	F1	70	10
ND16-22A/2/Y/230	5,90 €	F1	70	10

Referencia	P.V.P.	Fam.	Pag.	Emb.
ND16-22A/2/Y/24	5,90 €	F1	70	10
ND16-22A/2/Y/36	5,90 €	F1	70	10
ND16-22A/2/Y/400	5,90 €	F1	70	10
ND16-22A/2/Y/48	5,90 €	F1	70	10
ND16-22A/2/Y/6	5,90 €	F1	70	10
ND16-22A/2F/B/230	5,90 €	F1	70	10
ND16-22A/2F/B/400	5,90 €	F1	70	10
ND16-22A/2F/G/230	5,90 €	F1	70	10
ND16-22A/2F/G/400	5,90 €	F1	70	10
ND16-22A/2F/R/230	5,90 €	F1	70	10
ND16-22A/2F/R/400	5,90 €	F1	70	10
ND16-22A/2F/W/230	5,90 €	F1	70	10
ND16-22A/2F/W/400	5,90 €	F1	70	10
ND16-22A/2F/Y/230	5,90 €	F1	70	10
ND16-22A/2F/Y/400	5,90 €	F1	70	10
ND16-22A/4/B/110	5,90 €	F1	70	10
ND16-22A/4/B/230	5,90 €	F1	70	10
ND16-22A/4/B/400	5,90 €	F1	70	10
ND16-22A/4/G/110	5,90 €	F1	70	10
ND16-22A/4/G/230	5,90 €	F1	70	10
ND16-22A/4/G/400	5,90 €	F1	70	10
ND16-22A/4/R/110	5,90 €	F1	70	10
ND16-22A/4/R/230	5,90 €	F1	70	10
ND16-22A/4/R/400	5,90 €	F1	70	10
ND16-22A/4/W/110	5,90 €	F1	70	10
ND16-22A/4/W/230	5,90 €	F1	70	10
ND16-22A/4/W/400	5,90 €	F1	70	10
ND16-22A/4/Y/110	5,90 €	F1	70	10
ND16-22A/4/Y/230	5,90 €	F1	70	10
ND16-22A/4/Y/400	5,90 €	F1	70	10
ND16-22AS/2/B/12	5,90 €	F1	70	10
ND16-22AS/2/B/24	5,90 €	F1	70	10
ND16-22AS/2/B/36	5,90 €	F1	70	10
ND16-22AS/2/B/48	5,90 €	F1	70	10
ND16-22AS/2/B/6	5,90 €	F1	70	10
ND16-22AS/2/G/12	5,90 €	F1	70	10
ND16-22AS/2/G/24	5,90 €	F1	70	10
ND16-22AS/2/G/36	5,90 €	F1	70	10
ND16-22AS/2/G/48	5,90 €	F1	70	10
ND16-22AS/2/G/6	5,90 €	F1	70	10
ND16-22AS/2/R/12	5,90 €	F1	70	10
ND16-22AS/2/R/24	5,90 €	F1	70	10
ND16-22AS/2/R/36	5,90 €	F1	70	10
ND16-22AS/2/R/48	5,90 €	F1	70	10
ND16-22AS/2/R/6	5,90 €	F1	70	10
ND16-22AS/2/W/12	5,90 €	F1	70	10
ND16-22AS/2/W/24	5,90 €	F1	70	10
ND16-22AS/2/W/36	5,90 €	F1	70	10
ND16-22AS/2/W/48	5,90 €	F1	70	10
ND16-22AS/2/W/6	5,90 €	F1	70	10
ND16-22AS/2/Y/12	5,90 €	F1	70	10
ND16-22AS/2/Y/24	5,90 €	F1	70	10
ND16-22AS/2/Y/36	5,90 €	F1	70	10
ND16-22AS/2/Y/48	5,90 €	F1	70	10
ND16-22AS/2/Y/6	5,90 €	F1	70	10
ND16-22AS/4/B/12	5,90 €	F1	70	10
ND16-22AS/4/B/24	5,90 €	F1	70	10
ND16-22AS/4/B/36	5,90 €	F1	70	10
ND16-22AS/4/B/48	5,90 €	F1	70	10
ND16-22AS/4/B/6	5,90 €	F1	70	10
ND16-22AS/4/G/12	5,90 €	F1	70	10
ND16-22AS/4/G/24	5,90 €	F1	70	10
ND16-22AS/4/G/36	5,90 €	F1	70	10
ND16-22AS/4/G/48	5,90 €	F1	70	10
ND16-22AS/4/G/6	5,90 €	F1	70	10
ND16-22AS/4/R/12	5,90 €	F1	70	10
ND16-22AS/4/R/24	5,90 €	F1	70	10
ND16-22AS/4/R/36	5,90 €	F1	70	10
ND16-22AS/4/R/48	5,90 €	F1	70	10
ND16-22AS/4/R/6	5,90 €	F1	70	10

Referencia	P.V.P.	Fam.	Pag.	Emb.
ND16-22D/2F/B/230	5,90 €	F1	69	10
ND16-22D/2F/B/400	5,90 €	F1	69	10
ND16-22D/2F/G/230	5,90 €	F1	69	10
ND16-22D/2F/G/400	5,90 €	F1	69	10
ND16-22D/2F/R/230	5,90 €	F1	69	10
ND16-22D/2F/R/400	5,90 €	F1	69	10
ND16-22D/2F/W/230	5,90 €	F1	69	10
ND16-22D/2F/W/400	5,90 €	F1	69	10
ND16-22D/2F/Y/230	5,90 €	F1	69	10
ND16-22D/2F/Y/400	5,90 €	F1	69	10
ND16-22D/4/B/110	5,90 €	F1	69	10
ND16-22D/4/B/230	5,90 €	F1	69	10
ND16-22D/4/B/400	5,90 €	F1	69	10
ND16-22D/4/G/110	5,90 €	F1	69	10
ND16-22D/4/G/230	5,90 €	F1	69	10
ND16-22D/4/G/400	5,90 €	F1	69	10
ND16-22D/4/R/110	5,90 €	F1	69	10
ND16-22D/4/R/230	5,90 €	F1	69	10
ND16-22D/4/R/400	5,90 €	F1	69	10
ND16-22D/4/W/110	5,90 €	F1	69	10
ND16-22D/4/W/230	5,90 €	F1	69	10
ND16-22D/4/W/400	5,90 €	F1	69	10
ND16-22D/4/Y/110	5,90 €	F1	69	10
ND16-22D/4/Y/230	5,90 €	F1	69	10
ND16-22D/4/Y/400	5,90 €	F1	69	10
ND16-22DS/2/B/12	5,90 €	F1	69	10
ND16-22DS/2/B/24	5,90 €	F1	69	10
ND16-22DS/2/B/36	5,90 €	F1	69	10
ND16-22DS/2/B/48	5,90 €	F1	69	10
ND16-22DS/2/B/6	5,90 €	F1	69	10
ND16-22DS/2/G/12	5,90 €	F1	69	10
ND16-22DS/2/G/24	5,90 €	F1	69	10
ND16-22DS/2/G/36	5,90 €	F1	69	10
ND16-22DS/2/G/48	5,90 €	F1	69	10
ND16-22DS/2/G/6	5,90 €	F1	69	10
ND16-22DS/2/R/12	5,90 €	F1	69	10
ND16-22DS/2/R/24	5,90 €	F1	69	10
ND16-22DS/2/R/36	5,90 €	F1	69	10
ND16-22DS/2/R/48	5,90 €	F1	69	10
ND16-22DS/2/R/6	5,90 €	F1	69	10
ND16-22DS/2/W/12	5,90 €	F1	69	10
ND16-22DS/2/W/24	5,90 €	F1	69	10
ND16-22DS/2/W/36	5,90 €	F1	69	10
ND16-22DS/2/W/48	5,90 €	F1	69	10
ND16-22DS/2/W/6	5,90 €	F1	69	10
ND16-22DS/2/Y/12	5,90 €	F1	69	10
ND16-22DS/2/Y/24	5,90 €	F1	69	10
ND16-22DS/2/Y/36	5,90 €	F1	69	10
ND16-22DS/2/Y/48	5,90 €	F1	69	10
ND16-22DS/2/Y/6	5,90 €	F1	69	10
ND16-22DS/4/B/12	5,90 €	F1	69	10
ND16-22DS/4/B/24	5,90 €	F1	69	10
ND16-22DS/4/B/36	5,90 €	F1	69	10
ND16-22DS/4/B/48	5,90 €	F1	69	10
ND16-22DS/4/B/6	5,90 €	F1	69	10
ND16-22DS/4/G/12	5,90 €	F1	69	10
ND16-22DS/4/G/24	5,90 €	F1	69	10
ND16-22DS/4/G/36	5,90 €	F1	69	10
ND16-22DS/4/G/48	5,90 €	F1	69	10
ND16-22DS/4/G/6	5,90 €	F1	69	10
ND16-22DS/4/R/12	5,90 €	F1	69	10
ND16-22DS/4/R/24	5,90 €	F1	69	10
ND16-22DS/4/R/36	5,90 €	F1	69	10
ND16-22DS/4/R/48	5,90 €	F1	69	10
ND16-22DS/4/R/6	5,90 €	F1	69	10
ND16-22DS/4/W/12	5,90 €	F1	69	10
ND16-22DS/4/W/24	5,90 €	F1	69	10
ND16-22DS/4/W/36	5,90 €	F1	69	10
ND16-22DS/4/W/48	5,90 €	F1	69	10
ND16-22DS/4/W/6	5,90 €	F1	69	10

Referencia	P.V.P.	Fam.	Pag.	Emb.
ND16-22DS/4/Y/12	5,90 €	F1	69	10
ND16-22DS/4/Y/24	5,90 €	F1	69	10
ND16-22DS/4/Y/36	5,90 €	F1	69	10
ND16-22DS/4/Y/48	5,90 €	F1	69	10
ND16-22DS/4/Y/6	5,90 €	F1	69	10
ND16-22F/B/110	29,30 €	F1	74	10
ND16-22F/B/230	29,30 €	F1	74	10
ND16-22F/B/24	29,30 €	F1	74	10
ND16-22F/B/400	29,30 €	F1	74	10
ND16-22F/R/110	29,30 €	F1	74	10
ND16-22F/R/230	29,30 €	F1	74	10
ND16-22F/R/24	29,30 €	F1	74	10
ND16-22F/R/400	29,30 €	F1	74	10
ND16-22FS/B/110	29,30 €	F1	74	10
ND16-22FS/B/230	29,30 €	F1	74	10
ND16-22FS/B/24	29,30 €	F1	74	10
ND16-22FS/B/400	29,30 €	F1	74	10
ND16-22FS/R/110	29,30 €	F1	74	10
ND16-22FS/R/230	29,30 €	F1	74	10
ND16-22FS/R/24	29,30 €	F1	74	10
ND16-22FS/R/400	29,30 €	F1	74	10
ND16-22L/B/110	29,30 €	F1	74	10
ND16-22L/B/230	29,30 €	F1	74	10
ND16-22L/B/24	29,30 €	F1	74	10
ND16-22L/B/400	29,30 €	F1	74	10
ND16-22L/R/110	29,30 €	F1	74	10
ND16-22L/R/230	29,30 €	F1	74	10
ND16-22L/R/24	29,30 €	F1	74	10
ND16-22L/R/400	29,30 €	F1	74	10
ND16-22LC/B/110	29,30 €	F1	74	10
ND16-22LC/B/230	29,30 €	F1	74	10
ND16-22LC/B/24	29,30 €	F1	74	10
ND16-22LC/B/400	29,30 €	F1	74	10
ND16-22LC/R/110	29,30 €	F1	74	10
ND16-22LC/R/230	29,30 €	F1	74	10
ND16-22LC/R/24	29,30 €	F1	74	10
ND16-22LC/R/400	29,30 €	F1	74	10
ND9-PA110	17,60 €	F1	23	12/180
ND9-PA12	17,60 €	F1	23	12/180
ND9-PA230	17,60 €	F1	23	12/180
ND9-PA24	17,60 €	F1	23	12/180
ND9-PA6,3	17,60 €	F1	23	12/180
ND9-PAA110	39,10 €	F1	25	12/180
ND9-PAA230	39,10 €	F1	25	12/180
ND9-PAA24	39,10 €	F1	25	12/180
ND9-PAB110	39,10 €	F1	25	12/180
ND9-PAB12	39,10 €	F1	25	12/180
ND9-PAB230	39,10 €	F1	25	12/180
ND9-PAB24	39,10 €	F1	25	12/180
ND9-PAB6,3	39,10 €	F1	25	12/180
ND9-PAZ110	39,10 €	F1	25	12/180
ND9-PAZ12	39,10 €	F1	25	12/180
ND9-PAZ230	39,10 €	F1	25	12/180
ND9-PAZ24	39,10 €	F1	25	12/180
ND9-PAZ6,3	39,10 €	F1	25	12/180
ND9-PB110	17,60 €	F1	23	12/180
ND9-PB12	17,60 €	F1	23	12/180
ND9-PB230	17,60 €	F1	23	12/180
ND9-PB24	17,60 €	F1	23	12/180
ND9-PB6,3	17,60 €	F1	23	12/180
ND9-PBB110	39,10 €	F1	25	12/180
ND9-PBB12	39,10 €	F1	25	12/180
ND9-PBB230	39,10 €	F1	25	12/180
ND9-PBB24	39,10 €	F1	25	12/180
ND9-PBB6,3	39,10 €	F1	25	12/180
ND9-PR110	17,60 €	F1	23	12/180
ND9-PR12	17,60 €	F1	23	12/180
ND9-PR230	17,60 €	F1	23	12/180
ND9-PR24	17,60 €	F1	23	12/180
ND9-PR6,3	17,60 €	F1	23	12/180

Referencia	P.V.P.	Fam.	Pag.	Emb.
ND9- PRA110	39,10 €	F1	24	12/180
ND9- PRA12	39,10 €	F1	24	12/180
ND9- PRA230	39,10 €	F1	24	12/180
ND9- PRA24	39,10 €	F1	24	12/180
ND9- PRA6,3	39,10 €	F1	24	12/180
ND9- PRB110	39,10 €	F1	25	12/180
ND9- PRB12	39,10 €	F1	25	12/180
ND9- PRB230	39,10 €	F1	25	12/180
ND9- PRB24	39,10 €	F1	25	12/180
ND9- PRB6,3	39,10 €	F1	25	12/180
ND9- PRR110	39,10 €	F1	24	12/180
ND9- PRR12	39,10 €	F1	24	12/180
ND9- PRR230	39,10 €	F1	24	12/180
ND9- PRR24	39,10 €	F1	24	12/180
ND9- PRR6,3	39,10 €	F1	24	12/180
ND9- PRZ110	39,10 €	F1	25	12/180
ND9- PRZ12	39,10 €	F1	25	12/180
ND9- PRZ230	39,10 €	F1	25	12/180
ND9- PRZ24	39,10 €	F1	25	12/180
ND9- PRZ6,3	39,10 €	F1	25	12/180
ND9- PV110	17,60 €	F1	23	12/180
ND9- PV12	17,60 €	F1	23	12/180
ND9- PV230	17,60 €	F1	23	12/180
ND9- PV24	17,60 €	F1	23	12/180
ND9- PV6,3	17,60 €	F1	23	12/180
ND9- PVA110	39,10 €	F1	24	12/180
ND9- PVA12	39,10 €	F1	24	12/180
ND9- PVA230	39,10 €	F1	24	12/180
ND9- PVA24	39,10 €	F1	24	12/180
ND9- PVA6,3	39,10 €	F1	24	12/180
ND9- PVB110	39,10 €	F1	24	12/180
ND9- PVB12	39,10 €	F1	24	12/180
ND9- PVB230	39,10 €	F1	24	12/180
ND9- PVB24	39,10 €	F1	24	12/180
ND9- PVB6,3	39,10 €	F1	24	12/180
ND9- PVR110	39,10 €	F1	24	12/180
ND9- PVR12	39,10 €	F1	24	12/180
ND9- PVR230	39,10 €	F1	24	12/180
ND9- PVR24	39,10 €	F1	24	12/180
ND9- PVR6,3	39,10 €	F1	24	12/180
ND9- PVV110	39,10 €	F1	24	12/180
ND9- PVV12	39,10 €	F1	24	12/180
ND9- PVV230	39,10 €	F1	24	12/180
ND9- PVV24	39,10 €	F1	24	12/180
ND9- PVV6,3	39,10 €	F1	24	12/180
ND9- PVZ110	39,10 €	F1	24	12/180
ND9- PVZ12	39,10 €	F1	24	12/180
ND9- PVZ230	39,10 €	F1	24	12/180
ND9- PVZ24	39,10 €	F1	24	12/180
ND9- PVZ6,3	39,10 €	F1	24	12/180
ND9- PZ110	17,60 €	F1	23	12/180
ND9- PZ12	17,60 €	F1	23	12/180
ND9- PZ230	17,60 €	F1	23	12/180
ND9- PZ24	17,60 €	F1	23	12/180
ND9- PZ6,3	17,60 €	F1	23	12/180
ND9- PZB110	39,10 €	F1	25	12/180
ND9- PZB12	39,10 €	F1	25	12/180
ND9- PZB230	39,10 €	F1	25	12/180
ND9- PZB24	39,10 €	F1	25	12/180
ND9- PZB6,3	39,10 €	F1	25	12/180
ND9- PZZ110	39,10 €	F1	25	12/180
ND9- PZZ230	39,10 €	F1	25	12/180
ND9- PZZ24	39,10 €	F1	25	12/180
NH40- 100/3	69,70 €	F2	93	1
NH40- 100/3S	155,10 €	F2	95	1
NH40- 100/3SW	159,00 €	F2	96	1
NH40- 100/3SZ/I	193,60 €	F2	97	1
NH40- 100/3SZ/II	193,60 €	F2	97	1
NH40- 100/3SZ/III	193,60 €	F2	97	1
NH40- 100/3W	71,90 €	F2	94	1

Referencia	P.V.P.	Fam.	Pag.	Emb.
NH40- 100/4	76,40 €	F2	93	1
NH40- 100/4S	168,50 €	F2	95	1
NH40- 100/4SW	172,10 €	F2	96	1
NH40- 100/4SZ/I	210,50 €	F2	97	1
NH40- 100/4SZ/II	210,50 €	F2	97	1
NH40- 100/4SZ/III	210,50 €	F2	97	1
NH40- 100/4W	80,00 €	F2	94	1
NH40- 1000/3	807,40 €	F2	93	1
NH40- 1000/3S	1.793,00 €	F2	95	1
NH40- 1000/3SW	1.798,30 €	F2	96	1
NH40- 1000/3SZ/I	2.240,60 €	F2	97	1
NH40- 1000/3SZ/II	2.240,60 €	F2	97	1
NH40- 1000/3SZ/III	2.240,60 €	F2	97	1
NH40- 1000/3W	817,90 €	F2	94	1
NH40- 1000/4	702,20 €	F2	93	1
NH40- 1000/4S	1.560,70 €	F2	95	1
NH40- 1000/4SW	1.563,00 €	F2	96	1
NH40- 1000/4SZ/I	1.950,80 €	F2	97	1
NH40- 1000/4SZ/II	1.950,80 €	F2	97	1
NH40- 1000/4SZ/III	1.950,80 €	F2	97	1
NH40- 1000/4W	712,70 €	F2	94	1
NH40- 125/3	77,70 €	F2	93	1
NH40- 125/3S	173,80 €	F2	95	1
NH40- 125/3SW	177,50 €	F2	96	1
NH40- 125/3SZ/I	216,00 €	F2	97	1
NH40- 125/3SZ/II	216,00 €	F2	97	1
NH40- 125/3SZ/III	216,00 €	F2	97	1
NH40- 125/3W	81,00 €	F2	94	1
NH40- 125/4	84,40 €	F2	93	1
NH40- 125/4S	200,00 €	F2	95	1
NH40- 125/4SW	204,00 €	F2	96	1
NH40- 125/4SZ/I	251,00 €	F2	97	1
NH40- 125/4SZ/II	251,00 €	F2	97	1
NH40- 125/4SZ/III	251,00 €	F2	97	1
NH40- 125/4W	95,00 €	F2	94	1
NH40- 1250/3	886,40 €	F2	93	1
NH40- 1250/3S	1.968,80 €	F2	95	1
NH40- 1250/3SW	1.972,00 €	F2	96	1
NH40- 1250/3SZ/I	2.462,90 €	F2	97	1
NH40- 1250/3SZ/II	2.462,90 €	F2	97	1
NH40- 1250/3SZ/III	2.462,90 €	F2	97	1
NH40- 1250/3W	896,80 €	F2	94	1
NH40- 1250/4	1.059,00 €	F2	93	1
NH40- 1250/4S	2.350,00 €	F2	95	1
NH40- 1250/4SW	2.357,10 €	F2	96	1
NH40- 1250/4SZ/I	2.941,10 €	F2	97	1
NH40- 1250/4SZ/II	2.941,10 €	F2	97	1
NH40- 1250/4SZ/III	2.941,10 €	F2	97	1
NH40- 1250/4W	1.071,60 €	F2	94	1
NH40- 16/3	35,00 €	F2	93	1
NH40- 16/3S	81,20 €	F2	95	1
NH40- 16/3SW	84,90 €	F2	96	1
NH40- 16/3SZ/I	102,00 €	F2	97	1
NH40- 16/3SZ/II	102,00 €	F2	97	1
NH40- 16/3SZ/III	102,00 €	F2	97	1
NH40- 16/3W	40,10 €	F2	94	1
NH40- 16/4	45,00 €	F2	93	1
NH40- 16/4S	90,50 €	F2	95	1
NH40- 16/4SW	93,60 €	F2	96	1
NH40- 16/4SZ/I	112,10 €	F2	97	1
NH40- 16/4SZ/II	112,10 €	F2	97	1
NH40- 16/4SZ/III	112,10 €	F2	97	1
NH40- 16/4W	50,10 €	F2	94	1
NH40- 160/3	81,30 €	F2	93	1
NH40- 160/3S	182,40 €	F2	95	1
NH40- 160/3SW	186,90 €	F2	96	1
NH40- 160/3SZ/I	227,40 €	F2	97	1
NH40- 160/3SZ/II	227,40 €	F2	97	1
NH40- 160/3SZ/III	227,40 €	F2	97	1
NH40- 160/3W	87,60 €	F2	94	1

Referencia	P.V.P.	Fam.	Pag.	Emb.
NH40-160/4	90,70 €	F2	93	1
NH40-160/4S	227,90 €	F2	95	1
NH40-160/4SW	209,30 €	F2	96	1
NH40-160/4SZ/I	258,90 €	F2	97	1
NH40-160/4SZ/II	258,90 €	F2	97	1
NH40-160/4SZ/III	258,90 €	F2	97	1
NH40-160/4W	101,30 €	F2	94	1
NH40-1600/3	965,20 €	F2	93	1
NH40-1600/3S	2.144,10 €	F2	95	1
NH40-1600/3SW	2.143,50 €	F2	96	1
NH40-1600/3SZ/I	2.686,00 €	F2	97	1
NH40-1600/3SZ/II	2.686,00 €	F2	97	1
NH40-1600/3SZ/III	2.686,00 €	F2	97	1
NH40-1600/3W	967,30 €	F2	94	1
NH40-1600/4	1.196,80 €	F2	93	1
NH40-1600/4S	2.990,70 €	F2	95	1
NH40-1600/4SW	2.997,00 €	F2	96	1
NH40-1600/4SZ/I	3.737,40 €	F2	97	1
NH40-1600/4SZ/II	3.737,40 €	F2	97	1
NH40-1600/4SZ/III	3.737,40 €	F2	97	1
NH40-1600/4W	1.204,30 €	F2	94	1
NH40-200/3	124,30 €	F2	93	1
NH40-200/3S	275,00 €	F2	95	1
NH40-200/3SW	279,70 €	F2	96	1
NH40-200/3SZ/I	343,60 €	F2	97	1
NH40-200/3SZ/II	343,60 €	F2	97	1
NH40-200/3SZ/III	343,60 €	F2	97	1
NH40-200/3W	130,60 €	F2	94	1
NH40-200/4	144,30 €	F2	93	1
NH40-200/4S	320,30 €	F2	95	1
NH40-200/4SW	329,50 €	F2	96	1
NH40-200/4SZ/I	401,60 €	F2	97	1
NH40-200/4SZ/II	401,60 €	F2	97	1
NH40-200/4SZ/III	401,60 €	F2	97	1
NH40-200/4W	154,80 €	F2	94	1
NH40-2000/3	2.330,50 €	F2	93	1
NH40-2000/3S	5.176,40 €	F2	95	1
NH40-2000/4	2.541,00 €	F2	93	1
NH40-2000/4S	5.647,30 €	F2	95	1
NH40-250/3	153,70 €	F2	93	1
NH40-250/3S	333,40 €	F2	95	1
NH40-250/3SW	338,00 €	F2	96	1
NH40-250/3SZ/I	416,70 €	F2	97	1
NH40-250/3SZ/II	416,70 €	F2	97	1
NH40-250/3SZ/III	416,70 €	F2	97	1
NH40-250/3W	159,00 €	F2	94	1
NH40-250/4	174,80 €	F2	93	1
NH40-250/4S	388,90 €	F2	95	1
NH40-250/4SW	395,70 €	F2	96	1
NH40-250/4SZ/I	485,30 €	F2	97	1
NH40-250/4SZ/II	485,30 €	F2	97	1
NH40-250/4SZ/III	485,30 €	F2	97	1
NH40-250/4W	185,30 €	F2	94	1
NH40-2500/3	2.544,20 €	F2	93	1
NH40-2500/3S	5.659,60 €	F2	95	1
NH40-2500/4	2.734,70 €	F2	93	1
NH40-2500/4S	6.075,20 €	F2	95	1
NH40-315/3	173,70 €	F2	93	1
NH40-315/3S	384,20 €	F2	95	1
NH40-315/3SW	385,40 €	F2	96	1
NH40-315/3SZ/I	480,80 €	F2	97	1
NH40-315/3SZ/II	480,80 €	F2	97	1
NH40-315/3SZ/III	480,80 €	F2	97	1
NH40-315/3W	180,10 €	F2	94	1
NH40-315/4	205,30 €	F2	93	1
NH40-315/4S	455,10 €	F2	95	1
NH40-315/4SW	459,80 €	F2	96	1
NH40-315/4SZ/I	568,30 €	F2	97	1
NH40-315/4SZ/II	568,30 €	F2	97	1
NH40-315/4SZ/III	568,30 €	F2	97	1

Referencia	P.V.P.	Fam.	Pag.	Emb.
NH40-315/4W	215,80 €	F2	94	1
NH40-3150/3	2.713,70 €	F2	93	1
NH40-3150/3S	6.031,00 €	F2	95	1
NH40-3150/4	2.962,10 €	F2	93	1
NH40-3150/4S	6.582,60 €	F2	95	1
NH40-32/3	43,80 €	F2	93	1
NH40-32/3S	97,70 €	F2	95	1
NH40-32/3SW	99,90 €	F2	96	1
NH40-32/3SZ/I	121,10 €	F2	97	1
NH40-32/3SZ/II	121,10 €	F2	97	1
NH40-32/3SZ/III	121,10 €	F2	97	1
NH40-32/3W	48,40 €	F2	94	1
NH40-32/4	53,40 €	F2	93	1
NH40-32/4S	117,30 €	F2	95	1
NH40-32/4SW	121,10 €	F2	96	1
NH40-32/4SZ/I	146,50 €	F2	97	1
NH40-32/4SZ/II	146,50 €	F2	97	1
NH40-32/4SZ/III	146,50 €	F2	97	1
NH40-32/4W	58,80 €	F2	94	1
NH40-40/3	45,60 €	F2	93	1
NH40-40/3S	102,40 €	F2	95	1
NH40-40/3SW	105,30 €	F2	96	1
NH40-40/3SZ/I	127,40 €	F2	97	1
NH40-40/3SZ/II	127,40 €	F2	97	1
NH40-40/3SZ/III	127,40 €	F2	97	1
NH40-40/3W	53,10 €	F2	94	1
NH40-40/4	60,10 €	F2	93	1
NH40-40/4S	133,20 €	F2	95	1
NH40-40/4SW	138,90 €	F2	96	1
NH40-40/4SZ/I	166,50 €	F2	97	1
NH40-40/4SZ/II	166,50 €	F2	97	1
NH40-40/4SZ/III	166,50 €	F2	97	1
NH40-40/4W	63,40 €	F2	94	1
NH40-400/3	212,70 €	F2	93	1
NH40-400/3S	471,80 €	F2	95	1
NH40-400/3SW	475,10 €	F2	96	1
NH40-400/3SZ/I	588,30 €	F2	97	1
NH40-400/3SZ/II	588,30 €	F2	97	1
NH40-400/3SZ/III	588,30 €	F2	97	1
NH40-400/3W	225,30 €	F2	94	1
NH40-400/4	246,40 €	F2	93	1
NH40-400/4S	546,30 €	F2	95	1
NH40-400/4SW	549,90 €	F2	96	1
NH40-400/4SZ/I	682,00 €	F2	97	1
NH40-400/4SZ/II	682,00 €	F2	97	1
NH40-400/4SZ/III	682,00 €	F2	97	1
NH40-400/4W	256,90 €	F2	94	1
NH40-63/3	55,50 €	F2	93	1
NH40-63/3S	124,00 €	F2	95	1
NH40-63/3SW	127,70 €	F2	96	1
NH40-63/3SZ/I	155,50 €	F2	97	1
NH40-63/3SZ/II	155,50 €	F2	97	1
NH40-63/3SZ/III	155,50 €	F2	97	1
NH40-63/3W	61,70 €	F2	94	1
NH40-63/4	65,40 €	F2	93	1
NH40-63/4S	144,40 €	F2	95	1
NH40-63/4SW	148,30 €	F2	96	1
NH40-63/4SZ/I	180,70 €	F2	97	1
NH40-63/4SZ/II	180,70 €	F2	97	1
NH40-63/4SZ/III	180,70 €	F2	97	1
NH40-63/4W	68,60 €	F2	94	1
NH40-630/3	270,60 €	F2	93	1
NH40-630/3S	590,90 €	F2	95	1
NH40-630/3SW	595,70 €	F2	96	1
NH40-630/3SZ/I	737,40 €	F2	97	1
NH40-630/3SZ/II	737,40 €	F2	97	1
NH40-630/3SZ/III	737,40 €	F2	97	1
NH40-630/3W	281,10 €	F2	94	1
NH40-630/4	308,50 €	F2	93	1
NH40-630/4S	684,80 €	F2	95	1

Referencia	P.V.P.	Fam.	Pag.	Emb.
NH40-630/4SW	688,70 €	F2	96	1
NH40-630/4SZ/I	855,50 €	F2	97	1
NH40-630/4SZ/II	855,50 €	F2	97	1
NH40-630/4SZ/III	855,50 €	F2	97	1
NH40-630/4W	319,00 €	F2	94	1
NH40-80/3	62,10 €	F2	93	1
NH40-80/3S	137,30 €	F2	95	1
NH40-80/3SW	141,20 €	F2	96	1
NH40-80/3SZ/I	175,40 €	F2	97	1
NH40-80/3SZ/II	175,40 €	F2	97	1
NH40-80/3SZ/III	175,40 €	F2	97	1
NH40-80/3W	66,20 €	F2	94	1
NH40-80/4	69,80 €	F2	93	1
NH40-80/4S	155,00 €	F2	95	1
NH40-80/4SW	158,70 €	F2	96	1
NH40-80/4SZ/I	193,20 €	F2	97	1
NH40-80/4SZ/II	193,20 €	F2	97	1
NH40-80/4SZ/III	193,20 €	F2	97	1
NH40-80/4W	75,00 €	F2	94	1
NH4-1-100	15,40 €	F1	21	12/180
NH4-1-125	23,10 €	F1	21	12/180
NH4-1-32	8,70 €	F1	21	12/180
NH4-1-63	14,40 €	F1	21	12/180
NH4-2-100	42,00 €	F1	21	6/90
NH4-2-125	46,85 €	F1	21	6/90
NH4-2-32	12,70 €	F1	21	6/90
NH4-2-63	19,10 €	F1	21	6/90
NH4-3-100	50,40 €	F1	21	4/60
NH4-3-125	63,70 €	F1	21	4/60
NH4-3-32	17,00 €	F1	21	4/60
NH4-3-63	36,90 €	F1	21	4/60
NH4-4-100	66,10 €	F1	21	3/45
NH4-4-125	79,40 €	F1	21	3/45
NH4-4-32	21,20 €	F1	21	3/45
NH4-4-63	44,60 €	F1	21	3/45
NH9-1-32	11,70 €	F1	21	12/180
NH9-2-32	18,70 €	F1	21	12/180
NH9-3-32	26,00 €	F1	21	12/180
NH9-4-32	33,20 €	F1	21	12/180
NHR17-160/3/1	140,50 €	F3	98	1
NHR17-250/3/1	212,00 €	F3	98	1
NHR17-400/3/1	259,60 €	F3	98	1
NHR17-630/3/1	363,50 €	F3	98	1
NHR40-160/3	220,40 €	F3	98	1
NHR40-160/3W	230,40 €	F3	98	1
NHR40-160/4	265,50 €	F3	98	1
NHR40-160/4W	275,50 €	F3	98	1
NHR40-250/3	325,10 €	F3	98	1
NHR40-250/3W	337,50 €	F3	98	1
NHR40-250/4	406,80 €	F3	98	1
NHR40-250/4W	417,20 €	F3	98	1
NHR40-400/3	391,50 €	F3	98	1
NHR40-400/3W	405,10 €	F3	98	1
NHR40-400/4	485,10 €	F3	98	1
NHR40-400/4W	496,00 €	F3	98	1
NHR40-630/3	695,40 €	F3	98	1
NHR40-630/3W	710,80 €	F3	98	1
NHR40-630/4	795,20 €	F3	98	1
NHR40-630/4W	812,60 €	F3	98	1
NHRT40-160/3/L	69,40 €	F3	98	1
NHRT40-250/3/L	71,50 €	F3	98	1
NHRT40-400/3/L	85,10 €	F3	98	1
NHRT40-630/3/L	86,30 €	F3	98	1
NL1-2-100-300ACS	410,90 €	F1	14	1/90
NL1-2-100-300AS	426,20 €	F1	14	1/90
NL1-2-16-10AC	85,90 €	F1	13	1/90
NL1-2-25-300A	121,20 €	F1	13	1/90
NL1-2-25-300A10	123,45 €	F1	13	1/90
NL1-2-25-300AC	79,90 €	F1	13	1/90
NL1-2-25-300AC10	80,50 €	F1	13	1/90

Referencia	P.V.P.	Fam.	Pag.	Emb.
NL1-2-25-300ASi	210,60 €	F1	14	1/90
NL1-2-25-30A	60,25 €	F1	13	1/90
NL1-2-25-30A10	128,80 €	F1	13	1/90
NL1-2-25-30AC	35,40 €	F1	13	1/90
NL1-2-25-30AC10	77,70 €	F1	13	1/90
NL1-2-25-30ASi	169,90 €	F1	14	1/90
NL1-2-40-300A	125,30 €	F1	13	1/90
NL1-2-40-300A10	127,60 €	F1	13	1/90
NL1-2-40-300AC	82,60 €	F1	13	1/90
NL1-2-40-300AC10	82,10 €	F1	13	1/90
NL1-2-40-300ASi	220,10 €	F1	14	1/90
NL1-2-40-30A	68,50 €	F1	13	1/90
NL1-2-40-30A10	130,70 €	F1	13	1/90
NL1-2-40-30AC	36,60 €	F1	13	1/90
NL1-2-40-30AC10	80,20 €	F1	13	1/90
NL1-2-40-30ASi	172,30 €	F1	14	1/90
NL1-2-63-300A	203,10 €	F1	13	1/90
NL1-2-63-300A10	207,20 €	F1	13	1/90
NL1-2-63-300AC	156,00 €	F1	13	1/90
NL1-2-63-300AC10	158,90 €	F1	13	1/90
NL1-2-63-300ACS	249,50 €	F1	14	1/90
NL1-2-63-300AS	267,70 €	F1	14	1/90
NL1-2-63-300ASi	286,10 €	F1	14	1/90
NL1-2-63-30A	229,60 €	F1	13	1/90
NL1-2-63-30A10	213,40 €	F1	13	1/90
NL1-2-63-30AC	214,60 €	F1	13	1/90
NL1-2-63-30AC10	222,50 €	F1	13	1/90
NL1-2-63-30ASi	328,65 €	F1	14	1/90
NL1-2-80-300ACS	398,60 €	F1	14	1/90
NL1-2-80-300AS	422,10 €	F1	14	1/90
NL1-4-100-300ACS	527,50 €	F1	14	1/45
NL1-4-100-300AS	514,70 €	F1	14	1/45
NL1-4-25-300A	159,70 €	F1	13	1/45
NL1-4-25-300A10	158,70 €	F1	13	1/45
NL1-4-25-300AC	138,40 €	F1	13	1/45
NL1-4-25-300AC10	140,50 €	F1	13	1/45
NL1-4-25-300ASi	290,50 €	F1	14	1/45
NL1-4-25-30A	188,70 €	F1	13	1/45
NL1-4-25-30A10	192,10 €	F1	13	1/45
NL1-4-25-30AC	161,10 €	F1	13	1/45
NL1-4-25-30AC10	160,60 €	F1	13	1/45
NL1-4-25-30ASi	298,45 €	F1	14	1/45
NL1-4-40-300A	177,40 €	F1	13	1/45
NL1-4-40-300A10	180,10 €	F1	13	1/45
NL1-4-40-300AC	141,10 €	F1	13	1/45
NL1-4-40-300AC10	142,90 €	F1	13	1/45
NL1-4-40-300ASi	299,75 €	F1	14	1/45
NL1-4-40-30A	206,90 €	F1	13	1/45
NL1-4-40-30A10	212,80 €	F1	13	1/45
NL1-4-40-30AC	161,10 €	F1	13	1/45
NL1-4-40-30AC10	166,20 €	F1	13	1/45
NL1-4-40-30ASi	310,10 €	F1	14	1/45
NL1-4-63-300A10	242,50 €	F1	13	1/45
NL1-4-63-300AC	179,10 €	F1	13	1/45
NL1-4-63-300AC10	200,00 €	F1	13	1/45
NL1-4-63-300ACS	313,60 €	F1	14	1/45
NL1-4-63-300AS	389,20 €	F1	14	1/45
NL1-4-63-300ASi	340,30 €	F1	14	1/45
NL1-4-63-30A10	383,50 €	F1	13	1/45
NL1-4-63-30AC	179,10 €	F1	13	1/45
NL1-4-63-30AC10	348,10 €	F1	13	1/45
NL1-4-63-30ASi	460,50 €	F1	14	1/45
NL1-4-80-300ACS	425,30 €	F1	14	1/45
NL1-4-80-300AS	489,20 €	F1	14	1/45
NM1-100H-3P-100A	155,90 €	F1	41	1
NM1-100H-3P-16A	121,00 €	F1	41	1
NM1-100H-3P-20A	121,00 €	F1	41	1
NM1-100H-3P-25A	121,00 €	F1	41	1
NM1-100H-3P-32A	121,00 €	F1	41	1
NM1-100H-3P-40A	121,00 €	F1	41	1

Referencia	P.V.P.	Fam.	Pag.	Emb.
NM8S-630S-4P-250A	1.769,30 €	F1	33	1
NM8S-630S-4P-315A	1.769,30 €	F1	33	1
NM8S-630S-4P-350A	1.769,30 €	F1	33	1
NM8S-630S-4P-400A	1.769,30 €	F1	33	1
NM8S-630S-4P-500A	1.769,30 €	F1	33	1
NM8S-630S-4P-630A	1.995,30 €	F1	33	1
NM8S-800H-3P-630A	2.576,20 €	F1	34	1
NM8S-800H-3P-700A	2.576,20 €	F1	34	1
NM8S-800H-3P-800A	2.769,00 €	F1	34	1
NM8S-800H-4P-630A	2.834,30 €	F1	34	1
NM8S-800H-4P-700A	2.834,30 €	F1	34	1
NM8S-800H-4P-800A	3.124,20 €	F1	34	1
NM8S-800S-3P-630A	1.956,00 €	F1	33	1
NM8S-800S-3P-700A	1.956,00 €	F1	33	1
NM8S-800S-3P-800A	2.438,10 €	F1	33	1
NM8S-800S-4P-630A	2.330,10 €	F1	33	1
NM8S-800S-4P-700A	2.330,10 €	F1	33	1
NM8S-800S-4P-800A	2.751,50 €	F1	33	1
NP2-B01	9,40 €	F1	73	1
NP2-B02	13,30 €	F1	73	1
NP2-B03	16,30 €	F1	73	1
NP2-B101H29	15,80 €	F1	73	1
NP2-B102	15,90 €	F1	73	1
NP2-B103	15,90 €	F1	73	1
NP2-B111H29	15,80 €	F1	73	1
NP2-B112	15,90 €	F1	73	1
NP2-B114	15,90 €	F1	73	1
NP2-B132H29	19,00 €	F1	73	1
NP2-B142H29	37,80 €	F1	73	1
NP2-B164H29	18,70 €	F1	73	1
NP2-B211H29	26,00 €	F1	73	1
NP2-B213	26,20 €	F1	73	1
NP2-B215	26,20 €	F1	73	1
NP2-B222	26,20 €	F1	73	1
NP2-B223	26,20 €	F1	73	1
NP2-B311H29	54,40 €	F1	73	1
NP2-B321H29	54,40 €	F1	73	1
NP2-B324	55,00 €	F1	73	1
NP2-B334	55,00 €	F1	73	1
NP2-B339	55,00 €	F1	73	1
NP2-B341H29	54,40 €	F1	73	1
NP2-B363	35,10 €	F1	73	1
NP2-B366	35,10 €	F1	73	1
NP2-BA11	8,40 €	F1	62	10
NP2-BA12	8,40 €	F1	62	10
NP2-BA13	9,15 €	F1	62	10
NP2-BA14	9,15 €	F1	62	10
NP2-BA15	9,15 €	F1	62	10
NP2-BA21	8,40 €	F1	62	10
NP2-BA22	8,40 €	F1	62	10
NP2-BA23	9,15 €	F1	62	10
NP2-BA24	9,15 €	F1	62	10
NP2-BA25	9,15 €	F1	62	10
NP2-BA31	8,40 €	F1	62	10
NP2-BA32	8,40 €	F1	62	10
NP2-BA33	9,15 €	F1	62	10
NP2-BA34	9,15 €	F1	62	10
NP2-BA35	9,15 €	F1	62	10
NP2-BA41	8,40 €	F1	62	10
NP2-BA42	8,40 €	F1	62	10
NP2-BA43	9,15 €	F1	62	10
NP2-BA44	9,15 €	F1	62	10
NP2-BA45	9,15 €	F1	62	10
NP2-BA51	8,40 €	F1	62	10
NP2-BA52	8,40 €	F1	62	10
NP2-BA53	9,15 €	F1	62	10
NP2-BA54	9,15 €	F1	62	10
NP2-BA55	9,15 €	F1	62	10
NP2-BA61	8,40 €	F1	62	10
NP2-BA62	8,40 €	F1	62	10

Referencia	P.V.P.	Fam.	Pag.	Emb.
NP2-BA63	9,15 €	F1	62	10
NP2-BA64	9,15 €	F1	62	10
NP2-BA65	9,15 €	F1	62	10
NP2-BC11	9,60 €	F1	68	10
NP2-BC12	9,60 €	F1	68	10
NP2-BC13	12,40 €	F1	68	10
NP2-BC14	12,40 €	F1	68	10
NP2-BC15	12,40 €	F1	68	10
NP2-BC21	9,60 €	F1	68	10
NP2-BC22	9,60 €	F1	68	10
NP2-BC23	12,40 €	F1	68	10
NP2-BC24	12,40 €	F1	68	10
NP2-BC25	12,40 €	F1	68	10
NP2-BC31	9,60 €	F1	68	10
NP2-BC32	9,60 €	F1	68	10
NP2-BC33	12,40 €	F1	68	10
NP2-BC34	12,40 €	F1	68	10
NP2-BC35	12,40 €	F1	68	10
NP2-BC41	9,60 €	F1	68	10
NP2-BC42	9,60 €	F1	68	10
NP2-BC43	12,40 €	F1	68	10
NP2-BC44	12,40 €	F1	68	10
NP2-BC45	12,40 €	F1	68	10
NP2-BC51	9,60 €	F1	68	10
NP2-BC52	9,60 €	F1	68	10
NP2-BC53	12,40 €	F1	68	10
NP2-BC54	12,40 €	F1	68	10
NP2-BC55	12,40 €	F1	68	10
NP2-BC61	9,60 €	F1	68	10
NP2-BC62	9,60 €	F1	68	10
NP2-BC63	12,40 €	F1	68	10
NP2-BC64	12,40 €	F1	68	10
NP2-BC65	12,40 €	F1	68	10
NP2-BD21	11,30 €	F1	72	10
NP2-BD22	11,30 €	F1	72	10
NP2-BD23	14,05 €	F1	72	10
NP2-BD24	14,05 €	F1	72	10
NP2-BD25	14,05 €	F1	72	10
NP2-BD31	11,40 €	F1	72	10
NP2-BD32	11,40 €	F1	72	10
NP2-BD33	14,10 €	F1	72	10
NP2-BD34	14,10 €	F1	72	10
NP2-BD35	14,10 €	F1	72	10
NP2-BD41	13,50 €	F1	72	10
NP2-BD42	13,50 €	F1	72	10
NP2-BD43	16,30 €	F1	72	10
NP2-BD44	16,30 €	F1	72	10
NP2-BD45	16,30 €	F1	72	10
NP2-BD51	13,00 €	F1	72	10
NP2-BD52	13,10 €	F1	72	10
NP2-BD53	15,80 €	F1	72	10
NP2-BD54	15,80 €	F1	72	10
NP2-BD55	15,80 €	F1	72	10
NP2-BE101	2,80 €	F1	74	10
NP2-BE102	2,80 €	F1	74	10
NP2-BG21	31,10 €	F1	72	10
NP2-BG21B	32,90 €	F1	72	10
NP2-BG22	31,10 €	F1	72	10
NP2-BG22B	32,90 €	F1	72	10
NP2-BG23	33,90 €	F1	72	10
NP2-BG23B	35,70 €	F1	72	10
NP2-BG24	33,90 €	F1	72	10
NP2-BG24B	35,70 €	F1	72	10
NP2-BG25	33,90 €	F1	72	10
NP2-BG25B	35,70 €	F1	72	10
NP2-BG31	33,50 €	F1	72	10
NP2-BG32	33,50 €	F1	72	10
NP2-BG33	36,20 €	F1	72	10
NP2-BG34	36,20 €	F1	72	10
NP2-BG35	36,20 €	F1	72	10

Referencia	P.V.P.	Fam.	Pag.	Emb.
NP2-BG3B1D	36,80 €	F1	72	10
NP2-BG3B2D	36,80 €	F1	72	10
NP2-BG3B3D	39,60 €	F1	72	10
NP2-BG3B4D	39,60 €	F1	72	10
NP2-BG3B5D	39,60 €	F1	72	10
NP2-BG41	34,20 €	F1	72	10
NP2-BG42	34,20 €	F1	72	10
NP2-BG43	37,00 €	F1	72	10
NP2-BG44	37,00 €	F1	72	10
NP2-BG45	37,00 €	F1	72	10
NP2-BG51	34,40 €	F1	72	10
NP2-BG52	34,40 €	F1	72	10
NP2-BG53	37,10 €	F1	72	10
NP2-BG54	37,10 €	F1	72	10
NP2-BG55	37,10 €	F1	72	10
NP2-BJ21	15,80 €	F1	72	10
NP2-BJ22	15,80 €	F1	72	10
NP2-BJ23	18,60 €	F1	72	10
NP2-BJ24	18,60 €	F1	72	10
NP2-BJ25	18,60 €	F1	72	10
NP2-BJ31	16,80 €	F1	72	10
NP2-BJ32	16,80 €	F1	72	10
NP2-BJ33	19,60 €	F1	72	10
NP2-BJ34	19,60 €	F1	72	10
NP2-BJ35	19,60 €	F1	72	10
NP2-BJ41	16,20 €	F1	72	10
NP2-BJ42	16,20 €	F1	72	10
NP2-BJ43	19,00 €	F1	72	10
NP2-BJ44	19,00 €	F1	72	10
NP2-BJ45	19,00 €	F1	72	10
NP2-BJ51	20,70 €	F1	72	10
NP2-BJ52	20,70 €	F1	72	10
NP2-BJ53	23,40 €	F1	72	10
NP2-BJ54	23,40 €	F1	72	10
NP2-BJ55	23,40 €	F1	72	10
NP2-BL8325	14,90 €	F1	64	10
NP2-BL8425	14,90 €	F1	64	10
NP2-BR11	11,70 €	F1	68	10
NP2-BR12	11,70 €	F1	68	10
NP2-BR13	14,40 €	F1	68	10
NP2-BR14	14,40 €	F1	68	10
NP2-BR15	14,40 €	F1	68	10
NP2-BR21	11,70 €	F1	68	10
NP2-BR22	11,70 €	F1	68	10
NP2-BR23	14,40 €	F1	68	10
NP2-BR24	14,40 €	F1	68	10
NP2-BR25	14,40 €	F1	68	10
NP2-BR31	11,70 €	F1	68	10
NP2-BR32	11,70 €	F1	68	10
NP2-BR33	14,40 €	F1	68	10
NP2-BR34	14,40 €	F1	68	10
NP2-BR35	14,40 €	F1	68	10
NP2-BR41	11,70 €	F1	68	10
NP2-BR42	11,70 €	F1	68	10
NP2-BR43	14,40 €	F1	68	10
NP2-BR44	14,40 €	F1	68	10
NP2-BR45	14,40 €	F1	68	10
NP2-BR51	11,70 €	F1	68	10
NP2-BR52	11,70 €	F1	68	10
NP2-BR53	14,40 €	F1	68	10
NP2-BR54	14,40 €	F1	68	10
NP2-BR55	14,40 €	F1	68	10
NP2-BR61	11,70 €	F1	68	10
NP2-BR62	11,70 €	F1	68	10
NP2-BR63	14,40 €	F1	68	10
NP2-BR64	14,40 €	F1	68	10
NP2-BR65	14,40 €	F1	68	10
NP2-BS441	21,50 €	F1	68	10
NP2-BS442	21,50 €	F1	68	10
NP2-BS443	24,30 €	F1	68	10

Referencia	P.V.P.	Fam.	Pag.	Emb.
NP2-BS444	24,30 €	F1	68	10
NP2-BS445	24,30 €	F1	68	10
NP2-BS541	22,70 €	F1	68	10
NP2-BS542	22,70 €	F1	68	10
NP2-BS543	25,50 €	F1	68	10
NP2-BS544	25,50 €	F1	68	10
NP2-BS545	25,50 €	F1	68	10
NP2-BS641	23,70 €	F1	68	10
NP2-BS642	23,70 €	F1	68	10
NP2-BS643	26,50 €	F1	68	10
NP2-BS644	26,50 €	F1	68	10
NP2-BS645	26,50 €	F1	68	10
NP2-BV41L/230	27,40 €	F1	69	10
NP2-BV43L/230	27,40 €	F1	69	10
NP2-BV44L/230	27,40 €	F1	69	10
NP2-BV45L/230	27,40 €	F1	69	10
NP2-BV46L/230	27,40 €	F1	69	10
NP2-BV51L/400	27,40 €	F1	69	10
NP2-BV53L/400	27,40 €	F1	69	10
NP2-BV54L/400	27,40 €	F1	69	10
NP2-BV55L/400	27,40 €	F1	69	10
NP2-BV56L/400	27,40 €	F1	69	10
NP2-BV61L/110	9,50 €	F1	69	10
NP2-BV61L/12	9,50 €	F1	69	10
NP2-BV61L/230	9,50 €	F1	69	10
NP2-BV61L/24	9,50 €	F1	69	10
NP2-BV61L/36	9,50 €	F1	69	10
NP2-BV61L/48	9,50 €	F1	69	10
NP2-BV61L/6	9,50 €	F1	69	10
NP2-BV63L/110	9,50 €	F1	69	10
NP2-BV63L/12	9,50 €	F1	69	10
NP2-BV63L/230	9,50 €	F1	69	10
NP2-BV63L/24	9,50 €	F1	69	10
NP2-BV63L/36	9,50 €	F1	69	10
NP2-BV63L/48	9,50 €	F1	69	10
NP2-BV63L/6	9,50 €	F1	69	10
NP2-BV64L/110	9,50 €	F1	69	10
NP2-BV64L/12	9,50 €	F1	69	10
NP2-BV64L/230	9,50 €	F1	69	10
NP2-BV64L/24	9,50 €	F1	69	10
NP2-BV64L/36	9,50 €	F1	69	10
NP2-BV64L/48	9,50 €	F1	69	10
NP2-BV64L/6	9,50 €	F1	69	10
NP2-BV65L/110	9,50 €	F1	69	10
NP2-BV65L/12	9,50 €	F1	69	10
NP2-BV65L/230	9,50 €	F1	69	10
NP2-BV65L/24	9,50 €	F1	69	10
NP2-BV65L/36	9,50 €	F1	69	10
NP2-BV65L/48	9,50 €	F1	69	10
NP2-BV65L/6	9,50 €	F1	69	10
NP2-BV66L/110	9,50 €	F1	69	10
NP2-BV66L/12	9,50 €	F1	69	10
NP2-BV66L/230	9,50 €	F1	69	10
NP2-BV66L/24	9,50 €	F1	69	10
NP2-BV66L/36	9,50 €	F1	69	10
NP2-BV66L/48	9,50 €	F1	69	10
NP2-BV66L/6	9,50 €	F1	69	10
NP2-BW3141L/230	33,30 €	F1	66	10
NP2-BW3142L/230	33,30 €	F1	66	10
NP2-BW3143L/230	36,00 €	F1	66	10
NP2-BW3144L/230	36,00 €	F1	66	10
NP2-BW3145L/230	36,00 €	F1	66	10
NP2-BW3151L/400	33,30 €	F1	66	10
NP2-BW3152L/400	33,30 €	F1	66	10
NP2-BW3153L/400	36,00 €	F1	66	10
NP2-BW3154L/400	36,00 €	F1	66	10
NP2-BW3155L/400	36,00 €	F1	66	10
NP2-BW3161L/110	21,00 €	F1	64	10
NP2-BW3161L/12	21,00 €	F1	64	10
NP2-BW3161L/230	21,00 €	F1	64	10

Referencia	P.V.P.	Fam.	Pag.	Emb.
NP2- BW3562/L/12	21,00 €	F1	64	10
NP2- BW3562/L/230	21,00 €	F1	64	10
NP2- BW3562/L/24	21,00 €	F1	64	10
NP2- BW3562/L/36	21,00 €	F1	64	10
NP2- BW3562/L/48	21,00 €	F1	64	10
NP2- BW3562/L/6	21,00 €	F1	64	10
NP2- BW3563/L/110	23,70 €	F1	64	10
NP2- BW3563/L/12	23,70 €	F1	64	10
NP2- BW3563/L/230	23,70 €	F1	64	10
NP2- BW3563/L/24	23,70 €	F1	64	10
NP2- BW3563/L/36	23,70 €	F1	64	10
NP2- BW3563/L/48	23,70 €	F1	64	10
NP2- BW3563/L/6	23,70 €	F1	64	10
NP2- BW3564/L/110	23,70 €	F1	64	10
NP2- BW3564/L/12	23,70 €	F1	64	10
NP2- BW3564/L/230	23,70 €	F1	64	10
NP2- BW3564/L/24	23,70 €	F1	64	10
NP2- BW3564/L/36	23,70 €	F1	64	10
NP2- BW3564/L/48	23,70 €	F1	64	10
NP2- BW3564/L/6	23,70 €	F1	64	10
NP2- BW3565/L/110	23,70 €	F1	64	10
NP2- BW3565/L/12	23,70 €	F1	64	10
NP2- BW3565/L/230	23,70 €	F1	64	10
NP2- BW3565/L/24	23,70 €	F1	64	10
NP2- BW3565/L/36	23,70 €	F1	64	10
NP2- BW3565/L/48	23,70 €	F1	64	10
NP2- BW3565/L/6	23,70 €	F1	64	10
NP2- BW3641/L/230	33,30 €	F1	66	10
NP2- BW3642/L/230	33,30 €	F1	66	10
NP2- BW3643/L/230	36,00 €	F1	66	10
NP2- BW3644/L/230	36,00 €	F1	66	10
NP2- BW3645/L/230	36,00 €	F1	66	10
NP2- BW3651/L/400	33,30 €	F1	66	10
NP2- BW3652/L/400	33,30 €	F1	66	10
NP2- BW3653/L/400	36,00 €	F1	66	10
NP2- BW3654/L/400	36,00 €	F1	66	10
NP2- BW3655/L/400	36,00 €	F1	66	10
NP2- BW3661/L/110	21,00 €	F1	64	10
NP2- BW3661/L/12	21,00 €	F1	64	10
NP2- BW3661/L/230	21,00 €	F1	64	10
NP2- BW3661/L/24	21,00 €	F1	64	10
NP2- BW3661/L/36	21,00 €	F1	64	10
NP2- BW3661/L/48	21,00 €	F1	64	10
NP2- BW3661/L/6	21,00 €	F1	64	10
NP2- BW3662/L/110	21,00 €	F1	64	10
NP2- BW3662/L/12	21,00 €	F1	64	10
NP2- BW3662/L/230	21,00 €	F1	64	10
NP2- BW3662/L/24	21,00 €	F1	64	10
NP2- BW3662/L/36	21,00 €	F1	64	10
NP2- BW3662/L/48	21,00 €	F1	64	10
NP2- BW3662/L/6	21,00 €	F1	64	10
NP2- BW3663/L/110	23,70 €	F1	64	10
NP2- BW3663/L/12	23,70 €	F1	64	10
NP2- BW3663/L/230	23,70 €	F1	64	10
NP2- BW3663/L/24	23,70 €	F1	64	10
NP2- BW3663/L/36	23,70 €	F1	64	10
NP2- BW3663/L/48	23,70 €	F1	64	10
NP2- BW3663/L/6	23,70 €	F1	64	10
NP2- BW3664/L/110	23,70 €	F1	64	10
NP2- BW3664/L/12	23,70 €	F1	64	10
NP2- BW3664/L/230	23,70 €	F1	64	10
NP2- BW3664/L/24	23,70 €	F1	64	10
NP2- BW3664/L/36	23,70 €	F1	64	10
NP2- BW3664/L/48	23,70 €	F1	64	10
NP2- BW3664/L/6	23,70 €	F1	64	10
NP2- BW3665/L/110	23,70 €	F1	64	10
NP2- BW3665/L/12	23,70 €	F1	64	10
NP2- BW3665/L/230	23,70 €	F1	64	10
NP2- BW3665/L/24	23,70 €	F1	64	10
NP2- BW3665/L/36	23,70 €	F1	64	10

Referencia	P.V.P.	Fam.	Pag.	Emb.
NP2- BW3665/L/48	23,70 €	F1	64	10
NP2- BW3665/L/6	23,70 €	F1	64	10
NP2- BW8465/L/110	20,90 €	F1	64	10
NP2- BW8465/L/12	20,90 €	F1	64	10
NP2- BW8465/L/230	20,90 €	F1	64	10
NP2- BW8465/L/24	20,90 €	F1	64	10
NP2- BW8465/L/36	20,90 €	F1	64	10
NP2- BW8465/L/48	20,90 €	F1	64	10
NP2- BW8465/L/6	20,90 €	F1	64	10
NP2- BW8475/L/230	26,80 €	F1	64	10
NP2- BW8475/L/380	26,80 €	F1	64	10
NP2- BW8475/L/6	26,80 €	F1	64	10
NP2- BX01	2,30 €	F1	74	10
NP2- BX02	2,30 €	F1	74	10
NP2- BX03	2,30 €	F1	74	10
NP2- BX04	2,50 €	F1	74	10
NP2- BY8101	8,20 €	F1	74	1
NP2- BY8330	8,40 €	F1	74	1
NP2- BY9101	7,20 €	F1	74	1
NP2- BY9330	7,40 €	F1	74	1
NP2- BZ- **	14,00 €	F1	74	1
NP2- BZ00	2,30 €	F1	74	1
NP2- BZ31	2,20 €	F1	74	1
NP2- EA11	6,35 €	F1	61	10
NP2- EA12	6,35 €	F1	61	10
NP2- EA13	7,80 €	F1	61	10
NP2- EA14	7,80 €	F1	61	10
NP2- EA15	7,80 €	F1	61	10
NP2- EA21	6,35 €	F1	61	10
NP2- EA22	6,35 €	F1	61	10
NP2- EA23	7,80 €	F1	61	10
NP2- EA24	7,80 €	F1	61	10
NP2- EA25	7,80 €	F1	61	10
NP2- EA31	6,35 €	F1	61	10
NP2- EA32	6,35 €	F1	61	10
NP2- EA33	7,80 €	F1	61	10
NP2- EA34	7,80 €	F1	61	10
NP2- EA35	7,80 €	F1	61	10
NP2- EA41	6,35 €	F1	61	10
NP2- EA42	6,35 €	F1	61	10
NP2- EA43	7,80 €	F1	61	10
NP2- EA44	7,80 €	F1	61	10
NP2- EA45	7,80 €	F1	61	10
NP2- EA51	6,35 €	F1	61	10
NP2- EA52	6,35 €	F1	61	10
NP2- EA53	7,80 €	F1	61	10
NP2- EA54	7,80 €	F1	61	10
NP2- EA55	7,80 €	F1	61	10
NP2- EA61	6,35 €	F1	61	10
NP2- EA62	6,35 €	F1	61	10
NP2- EA63	7,80 €	F1	61	10
NP2- EA64	7,80 €	F1	61	10
NP2- EA65	7,80 €	F1	61	10
NP2- EC11	9,30 €	F1	67	10
NP2- EC12	9,30 €	F1	67	10
NP2- EC13	12,10 €	F1	67	10
NP2- EC14	12,10 €	F1	67	10
NP2- EC15	12,10 €	F1	67	10
NP2- EC21	9,30 €	F1	67	10
NP2- EC22	9,30 €	F1	67	10
NP2- EC23	12,10 €	F1	67	10
NP2- EC24	12,10 €	F1	67	10
NP2- EC25	12,10 €	F1	67	10
NP2- EC3	12,10 €	F1	67	10
NP2- EC31	9,30 €	F1	67	10
NP2- EC32	9,30 €	F1	67	10
NP2- EC33	12,10 €	F1	67	10
NP2- EC35	12,10 €	F1	67	10
NP2- EC41	9,30 €	F1	67	10
NP2- EC42	9,30 €	F1	67	10

Referencia	P.V.P.	Fam.	Pag.	Emb.
NP2-EC43	12,10 €	F1	67	10
NP2-EC44	12,10 €	F1	67	10
NP2-EC45	12,10 €	F1	67	10
NP2-EC51	9,30 €	F1	67	10
NP2-EC52	9,30 €	F1	67	10
NP2-EC53	12,10 €	F1	67	10
NP2-EC54	12,10 €	F1	67	10
NP2-EC55	12,10 €	F1	67	10
NP2-EC61	9,30 €	F1	67	10
NP2-EC62	9,30 €	F1	67	10
NP2-EC63	12,10 €	F1	67	10
NP2-EC64	12,10 €	F1	67	10
NP2-EC65	12,10 €	F1	67	10
NP2-ED21	9,60 €	F1	71	10
NP2-ED22	9,60 €	F1	71	10
NP2-ED23	12,40 €	F1	71	10
NP2-ED24	12,40 €	F1	71	10
NP2-ED25	12,40 €	F1	71	10
NP2-ED31	9,70 €	F1	71	10
NP2-ED32	9,70 €	F1	71	10
NP2-ED33	12,40 €	F1	71	10
NP2-ED34	12,40 €	F1	71	10
NP2-ED35	12,40 €	F1	71	10
NP2-ED41	11,70 €	F1	71	10
NP2-ED42	11,70 €	F1	71	10
NP2-ED43	14,50 €	F1	71	10
NP2-ED44	14,50 €	F1	71	10
NP2-ED45	14,50 €	F1	71	10
NP2-ED51	11,90 €	F1	71	10
NP2-ED52	11,90 €	F1	71	10
NP2-ED53	14,60 €	F1	71	10
NP2-ED54	14,60 €	F1	71	10
NP2-ED55	14,60 €	F1	71	10
NP2-EG21	28,40 €	F1	71	10
NP2-EG21B	30,40 €	F1	71	10
NP2-EG22	28,40 €	F1	71	10
NP2-EG22B	30,40 €	F1	71	10
NP2-EG23	31,20 €	F1	71	10
NP2-EG23B	33,20 €	F1	71	10
NP2-EG24	31,20 €	F1	71	10
NP2-EG24B	33,20 €	F1	71	10
NP2-EG25	31,20 €	F1	71	10
NP2-EG25B	33,20 €	F1	71	10
NP2-EG31	32,10 €	F1	71	10
NP2-EG32	32,10 €	F1	71	10
NP2-EG33	34,90 €	F1	71	10
NP2-EG34	34,90 €	F1	71	10
NP2-EG35	34,90 €	F1	71	10
NP2-EG3B1D	33,20 €	F1	71	10
NP2-EG3B2D	33,20 €	F1	71	10
NP2-EG3B3D	36,00 €	F1	71	10
NP2-EG3B4D	36,00 €	F1	71	10
NP2-EG3B5D	36,00 €	F1	71	10
NP2-EG41	31,60 €	F1	71	10
NP2-EG42	31,60 €	F1	71	10
NP2-EG43	34,40 €	F1	71	10
NP2-EG44	34,40 €	F1	71	10
NP2-EG45	34,40 €	F1	71	10
NP2-EG51	31,40 €	F1	71	10
NP2-EG52	31,40 €	F1	71	10
NP2-EG53	34,20 €	F1	71	10
NP2-EG54	34,20 €	F1	71	10
NP2-EG55	34,20 €	F1	71	10
NP2-EJ21	15,10 €	F1	71	10
NP2-EJ22	15,10 €	F1	71	10
NP2-EJ23	17,90 €	F1	71	10
NP2-EJ24	17,90 €	F1	71	10
NP2-EJ25	17,90 €	F1	71	10
NP2-EJ31	15,70 €	F1	71	10
NP2-EJ32	15,70 €	F1	71	10

Referencia	P.V.P.	Fam.	Pag.	Emb.
NP2-EJ33	18,40 €	F1	71	10
NP2-EJ34	18,40 €	F1	71	10
NP2-EJ35	18,40 €	F1	71	10
NP2-EJ41	15,70 €	F1	71	10
NP2-EJ42	15,70 €	F1	71	10
NP2-EJ43	18,50 €	F1	71	10
NP2-EJ44	18,50 €	F1	71	10
NP2-EJ45	18,50 €	F1	71	10
NP2-EJ51	16,30 €	F1	71	10
NP2-EJ52	16,30 €	F1	71	10
NP2-EJ53	19,10 €	F1	71	10
NP2-EJ54	19,10 €	F1	71	10
NP2-EJ55	19,10 €	F1	71	10
NP2-EL8325	13,20 €	F1	63	10
NP2-EL8425	13,20 €	F1	63	10
NP2-ER11	10,50 €	F1	67	10
NP2-ER12	10,50 €	F1	67	10
NP2-ER13	13,30 €	F1	67	10
NP2-ER14	13,30 €	F1	67	10
NP2-ER15	13,30 €	F1	67	10
NP2-ER21	10,50 €	F1	67	10
NP2-ER22	10,50 €	F1	67	10
NP2-ER23	13,30 €	F1	67	10
NP2-ER24	13,30 €	F1	67	10
NP2-ER25	13,30 €	F1	67	10
NP2-ER3	13,30 €	F1	67	10
NP2-ER31	10,50 €	F1	67	10
NP2-ER32	10,50 €	F1	67	10
NP2-ER33	13,30 €	F1	67	10
NP2-ER35	13,30 €	F1	67	10
NP2-ER41	10,50 €	F1	67	10
NP2-ER42	10,50 €	F1	67	10
NP2-ER43	13,30 €	F1	67	10
NP2-ER44	13,30 €	F1	67	10
NP2-ER45	13,30 €	F1	67	10
NP2-ER51	10,50 €	F1	67	10
NP2-ER52	10,50 €	F1	67	10
NP2-ER53	13,30 €	F1	67	10
NP2-ER54	13,30 €	F1	67	10
NP2-ER55	13,30 €	F1	67	10
NP2-ER61	10,50 €	F1	67	10
NP2-ER62	10,50 €	F1	67	10
NP2-ER63	13,30 €	F1	67	10
NP2-ER64	13,30 €	F1	67	10
NP2-ER65	13,30 €	F1	67	10
NP2-ES441	17,00 €	F1	67	10
NP2-ES442	17,00 €	F1	67	10
NP2-ES443	19,80 €	F1	67	10
NP2-ES444	19,80 €	F1	67	10
NP2-ES445	19,80 €	F1	67	10
NP2-ES541	18,10 €	F1	67	10
NP2-ES542	18,10 €	F1	67	10
NP2-ES543	20,90 €	F1	67	10
NP2-ES544	20,90 €	F1	67	10
NP2-ES545	20,90 €	F1	67	10
NP2-ES641	19,30 €	F1	67	10
NP2-ES642	19,30 €	F1	67	10
NP2-ES643	22,10 €	F1	67	10
NP2-ES644	22,10 €	F1	67	10
NP2-ES645	22,10 €	F1	67	10
NP2-EV41/L/230	23,90 €	F1	69	10
NP2-EV43/L/230	23,90 €	F1	69	10
NP2-EV44/L/230	23,90 €	F1	69	10
NP2-EV45/L/230	23,90 €	F1	69	10
NP2-EV46/L/230	23,90 €	F1	69	10
NP2-EV51/L/400	23,90 €	F1	69	10
NP2-EV53/L/400	23,90 €	F1	69	10
NP2-EV54/L/400	23,90 €	F1	69	10
NP2-EV55/L/400	23,90 €	F1	69	10
NP2-EV56/L/400	23,90 €	F1	69	10

Referencia	P.V.P.	Fam.	Pag.	Emb.
NP2-EW3461L/48	17,70 €	F1	63	10
NP2-EW3461L/6	17,70 €	F1	63	10
NP2-EW3462L/110	17,70 €	F1	63	10
NP2-EW3462L/12	17,70 €	F1	63	10
NP2-EW3462L/230	17,70 €	F1	63	10
NP2-EW3462L/24	17,70 €	F1	63	10
NP2-EW3462L/36	17,70 €	F1	63	10
NP2-EW3462L/48	17,70 €	F1	63	10
NP2-EW3462L/6	17,70 €	F1	63	10
NP2-EW3463L/110	20,40 €	F1	63	10
NP2-EW3463L/12	20,40 €	F1	63	10
NP2-EW3463L/230	20,40 €	F1	63	10
NP2-EW3463L/24	20,40 €	F1	63	10
NP2-EW3463L/36	20,40 €	F1	63	10
NP2-EW3463L/48	20,40 €	F1	63	10
NP2-EW3463L/6	20,40 €	F1	63	10
NP2-EW3464L/110	20,40 €	F1	63	10
NP2-EW3464L/12	20,40 €	F1	63	10
NP2-EW3464L/230	20,40 €	F1	63	10
NP2-EW3464L/24	20,40 €	F1	63	10
NP2-EW3464L/36	20,40 €	F1	63	10
NP2-EW3464L/48	20,40 €	F1	63	10
NP2-EW3464L/6	20,40 €	F1	63	10
NP2-EW3465L/110	20,40 €	F1	63	10
NP2-EW3465L/12	20,40 €	F1	63	10
NP2-EW3465L/230	20,40 €	F1	63	10
NP2-EW3465L/24	20,40 €	F1	63	10
NP2-EW3465L/36	20,40 €	F1	63	10
NP2-EW3465L/48	20,40 €	F1	63	10
NP2-EW3465L/6	20,40 €	F1	63	10
NP2-EW3541L/230	27,70 €	F1	65	10
NP2-EW3542L/230	27,70 €	F1	65	10
NP2-EW3543L/230	30,40 €	F1	65	10
NP2-EW3544L/230	30,40 €	F1	65	10
NP2-EW3545L/230	30,40 €	F1	65	10
NP2-EW3551L/400	27,70 €	F1	65	10
NP2-EW3552L/400	27,70 €	F1	65	10
NP2-EW3553L/400	30,40 €	F1	65	10
NP2-EW3554L/400	30,40 €	F1	65	10
NP2-EW3555L/400	30,40 €	F1	65	10
NP2-EW3561L/110	17,70 €	F1	63	10
NP2-EW3561L/12	17,70 €	F1	63	10
NP2-EW3561L/230	17,70 €	F1	63	10
NP2-EW3561L/24	17,70 €	F1	63	10
NP2-EW3561L/36	17,70 €	F1	63	10
NP2-EW3561L/48	17,70 €	F1	63	10
NP2-EW3561L/6	17,70 €	F1	63	10
NP2-EW3562L/110	17,70 €	F1	63	10
NP2-EW3562L/12	17,70 €	F1	63	10
NP2-EW3562L/230	17,70 €	F1	63	10
NP2-EW3562L/24	17,70 €	F1	63	10
NP2-EW3562L/36	17,70 €	F1	63	10
NP2-EW3562L/48	17,70 €	F1	63	10
NP2-EW3562L/6	17,70 €	F1	63	10
NP2-EW3563L/110	20,40 €	F1	63	10
NP2-EW3563L/12	20,40 €	F1	63	10
NP2-EW3563L/230	20,40 €	F1	63	10
NP2-EW3563L/24	20,40 €	F1	63	10
NP2-EW3563L/36	20,40 €	F1	63	10
NP2-EW3563L/48	20,40 €	F1	63	10
NP2-EW3563L/6	20,40 €	F1	63	10
NP2-EW3564L/110	20,40 €	F1	63	10
NP2-EW3564L/12	20,40 €	F1	63	10
NP2-EW3564L/230	20,40 €	F1	63	10
NP2-EW3564L/24	20,40 €	F1	63	10
NP2-EW3564L/36	20,40 €	F1	63	10
NP2-EW3564L/48	20,40 €	F1	63	10
NP2-EW3564L/6	20,40 €	F1	63	10
NP2-EW3565L/110	20,40 €	F1	63	10
NP2-EW3565L/12	20,40 €	F1	63	10

Referencia	P.V.P.	Fam.	Pag.	Emb.
NP2-EW3565L/230	20,40 €	F1	63	10
NP2-EW3565L/24	20,40 €	F1	63	10
NP2-EW3565L/36	20,40 €	F1	63	10
NP2-EW3565L/48	20,40 €	F1	63	10
NP2-EW3565L/6	20,40 €	F1	63	10
NP2-EW3641L/230	27,70 €	F1	65	10
NP2-EW3642L/230	27,70 €	F1	65	10
NP2-EW3643L/230	30,40 €	F1	65	10
NP2-EW3644L/230	30,40 €	F1	65	10
NP2-EW3645L/230	30,40 €	F1	65	10
NP2-EW3651L/400	27,70 €	F1	65	10
NP2-EW3652L/400	27,70 €	F1	65	10
NP2-EW3653L/400	30,40 €	F1	65	10
NP2-EW3654L/400	30,40 €	F1	65	10
NP2-EW3655L/400	30,40 €	F1	65	10
NP2-EW3661L/110	17,70 €	F1	63	10
NP2-EW3661L/12	17,70 €	F1	63	10
NP2-EW3661L/230	17,70 €	F1	63	10
NP2-EW3661L/24	17,70 €	F1	63	10
NP2-EW3661L/36	17,70 €	F1	63	10
NP2-EW3661L/48	17,70 €	F1	63	10
NP2-EW3661L/6	17,70 €	F1	63	10
NP2-EW3662L/110	17,70 €	F1	63	10
NP2-EW3662L/12	17,70 €	F1	63	10
NP2-EW3662L/230	17,70 €	F1	63	10
NP2-EW3662L/24	17,70 €	F1	63	10
NP2-EW3662L/36	17,70 €	F1	63	10
NP2-EW3662L/48	17,70 €	F1	63	10
NP2-EW3662L/6	17,70 €	F1	63	10
NP2-EW3663L/110	20,40 €	F1	63	10
NP2-EW3663L/12	20,40 €	F1	63	10
NP2-EW3663L/230	20,40 €	F1	63	10
NP2-EW3663L/24	20,40 €	F1	63	10
NP2-EW3663L/36	20,40 €	F1	63	10
NP2-EW3663L/48	20,40 €	F1	63	10
NP2-EW3663L/6	20,40 €	F1	63	10
NP2-EW3664L/110	20,40 €	F1	63	10
NP2-EW3664L/12	20,40 €	F1	63	10
NP2-EW3664L/230	20,40 €	F1	63	10
NP2-EW3664L/24	20,40 €	F1	63	10
NP2-EW3664L/36	20,40 €	F1	63	10
NP2-EW3664L/48	20,40 €	F1	63	10
NP2-EW3664L/6	20,40 €	F1	63	10
NP2-EW3665L/110	20,40 €	F1	63	10
NP2-EW3665L/12	20,40 €	F1	63	10
NP2-EW3665L/230	20,40 €	F1	63	10
NP2-EW3665L/24	20,40 €	F1	63	10
NP2-EW3665L/36	20,40 €	F1	63	10
NP2-EW3665L/48	20,40 €	F1	63	10
NP2-EW3665L/6	20,40 €	F1	63	10
NP2-EW4/EV4	6,80 €	F1	74	10
NP2-EW5/EV5	6,80 €	F1	74	10
NP2-EW6/EV6	3,80 €	F1	74	10
NP2-EW8465L/110	19,70 €	F1	63	10
NP2-EW8465L/12	19,70 €	F1	63	10
NP2-EW8465L/230	19,70 €	F1	63	10
NP2-EW8465L/24	19,70 €	F1	63	10
NP2-EW8465L/36	19,70 €	F1	63	10
NP2-EW8465L/48	19,70 €	F1	63	10
NP2-EW8465L/6	19,70 €	F1	63	10
NP2-EW8475L/230	25,30 €	F1	63	10
NP2-EW8475L/380	25,30 €	F1	63	10
NP2-EW8475L/6	25,30 €	F1	63	10
NP2-H361H29	54,40 €	F1	73	1
NP2-J01	9,40 €	F1	73	1
NP2-J174	27,50 €	F1	73	1
NP2-J174H29	27,50 €	F1	73	1
NP2-L1111	2,80 €	F1	74	10
NP2-L1121	2,80 €	F1	74	10
NP3-1	35,00 €	F1	78	1

Referencia	P.V.P.	Fam.	Pag.	Emb.
NP3- 1A	40,70 €	F1	78	1
NP3- 1B	40,70 €	F1	78	1
NP3- 1K	61,70 €	F1	78	1
NP3- 2	51,90 €	F1	78	1
NP3- 2A	57,50 €	F1	78	1
NP3- 2B	57,50 €	F1	78	1
NP3- 2K	78,50 €	F1	78	1
NP3- 3	68,70 €	F1	78	1
NP3- 3A	74,30 €	F1	78	1
NP3- 3B	74,30 €	F1	78	1
NP3- 3K	95,30 €	F1	78	1
NP3- 4	91,20 €	F1	78	1
NP3- 4A	96,80 €	F1	78	1
NP3- 4B	96,80 €	F1	78	1
NP3- 4K	117,80 €	F1	78	1
NP3- 5	112,35 €	F1	78	1
NP6- 11B/1F	16,50 €	F1	75	12
NP6- 11B/1J	16,50 €	F1	75	12
NP6- 11B/1Y	16,50 €	F1	75	12
NP6- 11B/2F	16,50 €	F1	75	12
NP6- 11B/2J	16,50 €	F1	75	12
NP6- 11B/2Y	16,50 €	F1	75	12
NP6- 11B/3F	16,50 €	F1	75	12
NP6- 11B/3J	16,50 €	F1	75	12
NP6- 11B/3Y	16,50 €	F1	75	12
NP6- 11B/4F	16,50 €	F1	75	12
NP6- 11B/4J	16,50 €	F1	75	12
NP6- 11B/4Y	16,50 €	F1	75	12
NP6- 11B/5F	16,50 €	F1	75	12
NP6- 11B/5J	16,50 €	F1	75	12
NP6- 11B/5Y	16,50 €	F1	75	12
NP6- 11B/6F	16,50 €	F1	75	12
NP6- 11B/6J	16,50 €	F1	75	12
NP6- 11B/6Y	16,50 €	F1	75	12
NP6- 11B/7F	16,50 €	F1	75	12
NP6- 11B/7J	16,50 €	F1	75	12
NP6- 11B/7Y	16,50 €	F1	75	12
NP6- 11BS/1F	16,50 €	F1	75	12
NP6- 11BS/1J	16,50 €	F1	75	12
NP6- 11BS/1Y	16,50 €	F1	75	12
NP6- 11BS/2F	16,50 €	F1	75	12
NP6- 11BS/2J	16,50 €	F1	75	12
NP6- 11BS/2Y	16,50 €	F1	75	12
NP6- 11BS/3F	16,50 €	F1	75	12
NP6- 11BS/3J	16,50 €	F1	75	12
NP6- 11BS/3Y	16,50 €	F1	75	12
NP6- 11BS/4F	16,50 €	F1	75	12
NP6- 11BS/4J	16,50 €	F1	75	12
NP6- 11BS/4Y	16,50 €	F1	75	12
NP6- 11BS/5F	16,50 €	F1	75	12
NP6- 11BS/5J	16,50 €	F1	75	12
NP6- 11BS/5Y	16,50 €	F1	75	12
NP6- 11BS/6F	16,50 €	F1	75	12
NP6- 11BS/6J	16,50 €	F1	75	12
NP6- 11BS/6Y	16,50 €	F1	75	12
NP6- 11BS/7F	16,50 €	F1	75	12
NP6- 11BS/7J	16,50 €	F1	75	12
NP6- 11BS/7Y	16,50 €	F1	75	12
NP6- 11D/1F/12	22,20 €	F1	76	12
NP6- 11D/1F/24	22,20 €	F1	76	12
NP6- 11D/1F/6	22,20 €	F1	76	12
NP6- 11D/1J/12	22,20 €	F1	76	12
NP6- 11D/1J/24	22,20 €	F1	76	12
NP6- 11D/1J/6	22,20 €	F1	76	12
NP6- 11D/1Y/12	22,20 €	F1	76	12
NP6- 11D/1Y/24	22,20 €	F1	76	12
NP6- 11D/1Y/6	22,20 €	F1	76	12
NP6- 11D/2F/12	22,20 €	F1	76	12
NP6- 11D/2F/24	22,20 €	F1	76	12
NP6- 11D/2F/6	22,20 €	F1	76	12

Referencia	P.V.P.	Fam.	Pag.	Emb.
NP6- 11D/2J/12	22,20 €	F1	76	12
NP6- 11D/2J/24	22,20 €	F1	76	12
NP6- 11D/2J/6	22,20 €	F1	76	12
NP6- 11D/2Y/12	22,20 €	F1	76	12
NP6- 11D/2Y/24	22,20 €	F1	76	12
NP6- 11D/2Y/6	22,20 €	F1	76	12
NP6- 11D/3F/12	22,20 €	F1	76	12
NP6- 11D/3F/24	22,20 €	F1	76	12
NP6- 11D/3F/6	22,20 €	F1	76	12
NP6- 11D/3J/12	22,20 €	F1	76	12
NP6- 11D/3J/24	22,20 €	F1	76	12
NP6- 11D/3J/6	22,20 €	F1	76	12
NP6- 11D/3Y/12	22,20 €	F1	76	12
NP6- 11D/3Y/24	22,20 €	F1	76	12
NP6- 11D/3Y/6	22,20 €	F1	76	12
NP6- 11D/4F/12	22,20 €	F1	76	12
NP6- 11D/4F/24	22,20 €	F1	76	12
NP6- 11D/4F/6	22,20 €	F1	76	12
NP6- 11D/4J/12	22,20 €	F1	76	12
NP6- 11D/4J/24	22,20 €	F1	76	12
NP6- 11D/4J/6	22,20 €	F1	76	12
NP6- 11D/4Y/12	22,20 €	F1	76	12
NP6- 11D/4Y/24	22,20 €	F1	76	12
NP6- 11D/4Y/6	22,20 €	F1	76	12
NP6- 11D/5F/12	22,20 €	F1	76	12
NP6- 11D/5F/24	22,20 €	F1	76	12
NP6- 11D/5F/6	22,20 €	F1	76	12
NP6- 11D/5J/12	22,20 €	F1	76	12
NP6- 11D/5J/24	22,20 €	F1	76	12
NP6- 11D/5J/6	22,20 €	F1	76	12
NP6- 11D/5Y/12	22,20 €	F1	76	12
NP6- 11D/5Y/24	22,20 €	F1	76	12
NP6- 11D/5Y/6	22,20 €	F1	76	12
NP6- 11D/6F/12	22,20 €	F1	76	12
NP6- 11D/6F/24	22,20 €	F1	76	12
NP6- 11D/6F/6	22,20 €	F1	76	12
NP6- 11D/6J/12	22,20 €	F1	76	12
NP6- 11D/6J/24	22,20 €	F1	76	12
NP6- 11D/6J/6	22,20 €	F1	76	12
NP6- 11D/6Y/12	22,20 €	F1	76	12
NP6- 11D/6Y/24	22,20 €	F1	76	12
NP6- 11D/6Y/6	22,20 €	F1	76	12
NP6- 11D/7F/12	22,20 €	F1	76	12
NP6- 11D/7F/24	22,20 €	F1	76	12
NP6- 11D/7F/6	22,20 €	F1	76	12
NP6- 11D/7J/12	22,20 €	F1	76	12
NP6- 11D/7J/24	22,20 €	F1	76	12
NP6- 11D/7J/6	22,20 €	F1	76	12
NP6- 11D/7Y/12	22,20 €	F1	76	12
NP6- 11D/7Y/24	22,20 €	F1	76	12
NP6- 11D/7Y/6	22,20 €	F1	76	12
NP6- 11DS/1F/12	22,20 €	F1	76	12
NP6- 11DS/1F/24	22,20 €	F1	76	12
NP6- 11DS/1F/6	22,20 €	F1	76	12
NP6- 11DS/1J/12	22,20 €	F1	76	12
NP6- 11DS/1J/24	22,20 €	F1	76	12
NP6- 11DS/1J/6	22,20 €	F1	76	12
NP6- 11DS/1Y/12	22,20 €	F1	76	12
NP6- 11DS/1Y/24	22,20 €	F1	76	12
NP6- 11DS/1Y/6	22,20 €	F1	76	12
NP6- 11DS/2F/12	22,20 €	F1	76	12
NP6- 11DS/2F/24	22,20 €	F1	76	12
NP6- 11DS/2F/6	22,20 €	F1	76	12
NP6- 11DS/2J/12	22,20 €	F1	76	12
NP6- 11DS/2J/24	22,20 €	F1	76	12
NP6- 11DS/2J/6	22,20 €	F1	76	12
NP6- 11DS/2Y/12	22,20 €	F1	76	12
NP6- 11DS/2Y/24	22,20 €	F1	76	12
NP6- 11DS/2Y/6	22,20 €	F1	76	12
NP6- 11DS/3F/12	22,20 €	F1	76	12

Referencia	P.V.P.	Fam.	Pag.	Emb.
NP6- 11DS/3F/24	22,20 €	F1	76	12
NP6- 11DS/3F/6	22,20 €	F1	76	12
NP6- 11DS/3J/12	22,20 €	F1	76	12
NP6- 11DS/3J/24	22,20 €	F1	76	12
NP6- 11DS/3J/6	22,20 €	F1	76	12
NP6- 11DS/3Y/12	22,20 €	F1	76	12
NP6- 11DS/3Y/24	22,20 €	F1	76	12
NP6- 11DS/3Y/6	22,20 €	F1	76	12
NP6- 11DS/4F/12	22,20 €	F1	76	12
NP6- 11DS/4F/24	22,20 €	F1	76	12
NP6- 11DS/4F/6	22,20 €	F1	76	12
NP6- 11DS/4J/12	22,20 €	F1	76	12
NP6- 11DS/4J/24	22,20 €	F1	76	12
NP6- 11DS/4J/6	22,20 €	F1	76	12
NP6- 11DS/4Y/12	22,20 €	F1	76	12
NP6- 11DS/4Y/24	22,20 €	F1	76	12
NP6- 11DS/4Y/6	22,20 €	F1	76	12
NP6- 11DS/5F/12	22,20 €	F1	76	12
NP6- 11DS/5F/24	22,20 €	F1	76	12
NP6- 11DS/5F/6	22,20 €	F1	76	12
NP6- 11DS/5J/12	22,20 €	F1	76	12
NP6- 11DS/5J/24	22,20 €	F1	76	12
NP6- 11DS/5J/6	22,20 €	F1	76	12
NP6- 11DS/5Y/12	22,20 €	F1	76	12
NP6- 11DS/5Y/24	22,20 €	F1	76	12
NP6- 11DS/5Y/6	22,20 €	F1	76	12
NP6- 11DS/6F/12	22,20 €	F1	76	12
NP6- 11DS/6F/24	22,20 €	F1	76	12
NP6- 11DS/6F/6	22,20 €	F1	76	12
NP6- 11DS/6J/12	22,20 €	F1	76	12
NP6- 11DS/6J/24	22,20 €	F1	76	12
NP6- 11DS/6J/6	22,20 €	F1	76	12
NP6- 11DS/6Y/12	22,20 €	F1	76	12
NP6- 11DS/6Y/24	22,20 €	F1	76	12
NP6- 11DS/6Y/6	22,20 €	F1	76	12
NP6- 11DS/7F/12	22,20 €	F1	76	12
NP6- 11DS/7F/24	22,20 €	F1	76	12
NP6- 11DS/7F/6	22,20 €	F1	76	12
NP6- 11DS/7J/12	22,20 €	F1	76	12
NP6- 11DS/7J/24	22,20 €	F1	76	12
NP6- 11DS/7J/6	22,20 €	F1	76	12
NP6- 11DS/7Y/12	22,20 €	F1	76	12
NP6- 11DS/7Y/24	22,20 €	F1	76	12
NP6- 11DS/7Y/6	22,20 €	F1	76	12
NP6- 11J/3	29,50 €	F1	77	12
NP6- 11J/4	29,50 €	F1	77	12
NP6- 11J/5	29,50 €	F1	77	12
NP6- 11X/2Y	35,20 €	F1	77	12
NP6- 11Y/2F	59,80 €	F1	77	12
NP6- 11Y/2J	59,80 €	F1	77	12
NP6- 11Y/2Y	59,80 €	F1	77	12
NP6- 11ZS/4	29,50 €	F1	77	12
NP6- 22B/1F	19,80 €	F1	75	12
NP6- 22B/1J	19,80 €	F1	75	12
NP6- 22B/1Y	19,80 €	F1	75	12
NP6- 22B/2F	19,80 €	F1	75	12
NP6- 22B/2J	19,80 €	F1	75	12
NP6- 22B/2Y	19,80 €	F1	75	12
NP6- 22B/3F	19,80 €	F1	75	12
NP6- 22B/3J	19,80 €	F1	75	12
NP6- 22B/3Y	19,80 €	F1	75	12
NP6- 22B/4F	19,80 €	F1	75	12
NP6- 22B/4J	19,80 €	F1	75	12
NP6- 22B/4Y	19,80 €	F1	75	12
NP6- 22B/5F	19,80 €	F1	75	12
NP6- 22B/5J	19,80 €	F1	75	12
NP6- 22B/5Y	19,80 €	F1	75	12
NP6- 22B/6F	19,80 €	F1	75	12
NP6- 22B/6J	19,80 €	F1	75	12
NP6- 22B/6Y	19,80 €	F1	75	12

Referencia	P.V.P.	Fam.	Pag.	Emb.
NP6- 22B/7F	19,80 €	F1	75	12
NP6- 22B/7J	19,80 €	F1	75	12
NP6- 22B/7Y	19,80 €	F1	75	12
NP6- 22BS/1F	19,80 €	F1	75	12
NP6- 22BS/1J	19,80 €	F1	75	12
NP6- 22BS/1Y	19,80 €	F1	75	12
NP6- 22BS/2F	19,80 €	F1	75	12
NP6- 22BS/2J	19,80 €	F1	75	12
NP6- 22BS/2Y	19,80 €	F1	75	12
NP6- 22BS/3F	19,80 €	F1	75	12
NP6- 22BS/3J	19,80 €	F1	75	12
NP6- 22BS/3Y	19,80 €	F1	75	12
NP6- 22BS/4F	19,80 €	F1	75	12
NP6- 22BS/4J	19,80 €	F1	75	12
NP6- 22BS/4Y	19,80 €	F1	75	12
NP6- 22BS/5F	19,80 €	F1	75	12
NP6- 22BS/5J	19,80 €	F1	75	12
NP6- 22BS/5Y	19,80 €	F1	75	12
NP6- 22BS/6F	19,80 €	F1	75	12
NP6- 22BS/6J	19,80 €	F1	75	12
NP6- 22BS/6Y	19,80 €	F1	75	12
NP6- 22BS/7F	19,80 €	F1	75	12
NP6- 22BS/7J	19,80 €	F1	75	12
NP6- 22BS/7Y	19,80 €	F1	75	12
NP6- 22D/1F/12	24,60 €	F1	76	12
NP6- 22D/1F/24	24,60 €	F1	76	12
NP6- 22D/1F/6	24,60 €	F1	76	12
NP6- 22D/1J/12	24,60 €	F1	76	12
NP6- 22D/1J/24	24,60 €	F1	76	12
NP6- 22D/1J/6	24,60 €	F1	76	12
NP6- 22D/1Y/12	24,60 €	F1	76	12
NP6- 22D/1Y/24	24,60 €	F1	76	12
NP6- 22D/1Y/6	24,60 €	F1	76	12
NP6- 22D/2F/12	24,60 €	F1	76	12
NP6- 22D/2F/24	24,60 €	F1	76	12
NP6- 22D/2F/6	24,60 €	F1	76	12
NP6- 22D/2J/12	24,60 €	F1	76	12
NP6- 22D/2J/24	24,60 €	F1	76	12
NP6- 22D/2J/6	24,60 €	F1	76	12
NP6- 22D/2Y/12	24,60 €	F1	76	12
NP6- 22D/2Y/24	24,60 €	F1	76	12
NP6- 22D/2Y/6	24,60 €	F1	76	12
NP6- 22D/3F/12	24,60 €	F1	76	12
NP6- 22D/3F/24	24,60 €	F1	76	12
NP6- 22D/3F/6	24,60 €	F1	76	12
NP6- 22D/3J/12	24,60 €	F1	76	12
NP6- 22D/3J/24	24,60 €	F1	76	12
NP6- 22D/3J/6	24,60 €	F1	76	12
NP6- 22D/3Y/12	24,60 €	F1	76	12
NP6- 22D/3Y/24	24,60 €	F1	76	12
NP6- 22D/3Y/6	24,60 €	F1	76	12
NP6- 22D/4F/12	24,60 €	F1	76	12
NP6- 22D/4F/24	24,60 €	F1	76	12
NP6- 22D/4F/6	24,60 €	F1	76	12
NP6- 22D/4J/12	24,60 €	F1	76	12
NP6- 22D/4J/24	24,60 €	F1	76	12
NP6- 22D/4J/6	24,60 €	F1	76	12
NP6- 22D/4Y/12	24,60 €	F1	76	12
NP6- 22D/4Y/24	24,60 €	F1	76	12
NP6- 22D/4Y/6	24,60 €	F1	76	12
NP6- 22D/5F/12	24,60 €	F1	76	12
NP6- 22D/5F/24	24,60 €	F1	76	12
NP6- 22D/5F/6	24,60 €	F1	76	12
NP6- 22D/5J/12	24,60 €	F1	76	12
NP6- 22D/5J/24	24,60 €	F1	76	12
NP6- 22D/5J/6	24,60 €	F1	76	12
NP6- 22D/5Y/12	24,60 €	F1	76	12
NP6- 22D/5Y/24	24,60 €	F1	76	12
NP6- 22D/5Y/6	24,60 €	F1	76	12
NP6- 22D/6F/12	24,60 €	F1	76	12

Referencia	P.V.P.	Fam.	Pag.	Emb.
NP6-XD/7J/12	13,50 €	F1	77	12
NP6-XD/7J/24	13,50 €	F1	77	12
NP6-XD/7J/6	13,50 €	F1	77	12
NP6-XD/7Y/12	13,50 €	F1	77	12
NP6-XD/7Y/24	13,50 €	F1	77	12
NP6-XD/7Y/6	13,50 €	F1	77	12
NP72/ADIR/10	30,70 €	F1	48	1
NP72/ADIR/100	30,70 €	F1	48	1
NP72/ADIR/15	30,70 €	F1	48	1
NP72/ADIR/20	30,70 €	F1	48	1
NP72/ADIR/40	30,70 €	F1	48	1
NP72/ADIR/5	30,70 €	F1	48	1
NP72/ADIR/60	30,70 €	F1	48	1
NP72/AIND/100	27,60 €	F1	48	1
NP72/AIND/1000	27,60 €	F1	48	1
NP72/AIND/1200	27,60 €	F1	48	1
NP72/AIND/150	27,60 €	F1	48	1
NP72/AIND/1500	27,60 €	F1	48	1
NP72/AIND/200	27,60 €	F1	48	1
NP72/AIND/2000	27,60 €	F1	48	1
NP72/AIND/250	27,60 €	F1	48	1
NP72/AIND/300	27,60 €	F1	48	1
NP72/AIND/3000	27,60 €	F1	48	1
NP72/AIND/350	27,60 €	F1	48	1
NP72/AIND/40	27,60 €	F1	48	1
NP72/AIND/400	27,60 €	F1	48	1
NP72/AIND/500	27,60 €	F1	48	1
NP72/AIND/60	27,60 €	F1	48	1
NP72/AIND/600	27,60 €	F1	48	1
NP72/AIND/75	27,60 €	F1	48	1
NP72/AIND/750	27,60 €	F1	48	1
NP72/AIND/800	27,60 €	F1	48	1
NP72/CB	10,50 €	F1	48	1
NP72/FREQ110	87,30 €	F1	48	1
NP72/FREQ220	87,30 €	F1	48	1
NP72/FREQ380	87,30 €	F1	48	1
NP72/PF	129,90 €	F1	48	1
NP72/VOLT230	31,40 €	F1	48	1
NP72/VOLT500	31,40 €	F1	48	1
NP72/WADIR	197,90 €	F1	48	1
NP72/WATRAF	214,50 €	F1	48	1
NP72/WRDIR	210,60 €	F1	48	1
NP72/WRTRAF	232,50 €	F1	48	1
NP9-PPR12-110	19,30 €	F1	26	12/180
NP9-PPR12-12	19,30 €	F1	26	12/180
NP9-PPR12-230	19,30 €	F1	26	12/180
NP9-PPR12-24	19,30 €	F1	26	12/180
NP9-PPR12-6,3	19,30 €	F1	26	12/180
NP9-PPR21-110	19,30 €	F1	26	12/180
NP9-PPR21-12	19,30 €	F1	26	12/180
NP9-PPR21-230	19,30 €	F1	26	12/180
NP9-PPR21-24	19,30 €	F1	26	12/180
NP9-PPR21-6,3	19,30 €	F1	26	12/180
NP9-PPR30-110	19,30 €	F1	26	12/180
NP9-PPR30-12	19,30 €	F1	26	12/180
NP9-PPR30-230	19,30 €	F1	26	12/180
NP9-PPR30-24	19,30 €	F1	26	12/180
NP9-PPR30-6,3	19,30 €	F1	26	12/180
NP9-PPV12-110	19,30 €	F1	26	12/180
NP9-PPV12-12	19,30 €	F1	26	12/180
NP9-PPV12-230	19,30 €	F1	26	12/180
NP9-PPV12-24	19,30 €	F1	26	12/180
NP9-PPV12-6,3	19,30 €	F1	26	12/180
NP9-PPV21-110	19,30 €	F1	26	12/180
NP9-PPV21-12	19,30 €	F1	26	12/180
NP9-PPV21-230	19,30 €	F1	26	12/180
NP9-PPV21-24	19,30 €	F1	26	12/180
NP9-PPV21-6,3	19,30 €	F1	26	12/180
NP9-PPV30-110	19,30 €	F1	26	12/180
NP9-PPV30-12	19,30 €	F1	26	12/180

Referencia	P.V.P.	Fam.	Pag.	Emb.
NP9-PPV30-230	19,30 €	F1	26	12/180
NP9-PPV30-24	19,30 €	F1	26	12/180
NP9-PPV30-6,3	19,30 €	F1	26	12/180
NP9-PR12-230	19,30 €	F1	26	12/180
NP9-PR21-230	19,30 €	F1	26	12/180
NP9-PR22-230	19,30 €	F1	26	12/180
NP9-PR30-230	19,30 €	F1	26	12/180
NP9-PV12-230	19,30 €	F1	26	12/180
NP9-PV21-230	19,30 €	F1	26	12/180
NP9-PV22-230	19,30 €	F1	26	12/180
NP9-PV30-230	19,30 €	F1	26	12/180
NQ2-15P/12-110	45,10 €	F2	57	1
NQ2-15P/12-230	45,10 €	F2	57	1
NQ2-15P/12-24	45,10 €	F2	57	1
NQ2-15P/12-400	45,10 €	F2	57	1
NQ2-15P/12-48	45,10 €	F2	57	1
NQ2-15P/18-110	58,35 €	F2	57	1
NQ2-15P/18-230	58,35 €	F2	57	1
NQ2-15P/18-24	58,35 €	F2	57	1
NQ2-15P/18-400	58,35 €	F2	57	1
NQ2-15P/18-48	58,35 €	F2	57	1
NQ2-15P/25-110	73,00 €	F2	57	1
NQ2-15P/25-230	73,00 €	F2	57	1
NQ2-15P/25-24	73,00 €	F2	57	1
NQ2-15P/25-400	73,00 €	F2	57	1
NQ2-15P/25-48	73,00 €	F2	57	1
NQ2-15P/32-110	108,00 €	F2	57	1
NQ2-15P/32-230	108,00 €	F2	57	1
NQ2-15P/32-24	108,00 €	F2	57	1
NQ2-15P/32-400	108,00 €	F2	57	1
NQ2-15P/32-48	108,00 €	F2	57	1
NR2-11.5-0,16	32,50 €	F1	54	1/100
NR2-11.5-0,25	32,50 €	F1	54	1/100
NR2-11.5-0,4	32,50 €	F1	54	1/100
NR2-11.5-0,63	32,50 €	F1	54	1/100
NR2-11.5-1	32,50 €	F1	54	1/100
NR2-11.5-1,6	32,50 €	F1	54	1/100
NR2-11.5-10	32,50 €	F1	54	1/100
NR2-11.5-13	32,50 €	F1	54	1/100
NR2-11.5-2	32,50 €	F1	54	1/100
NR2-11.5-2,5	32,50 €	F1	54	1/100
NR2-11.5-4	32,50 €	F1	54	1/100
NR2-11.5-6	32,50 €	F1	54	1/100
NR2-11.5-8	32,50 €	F1	54	1/100
NR2-150-104	250,40 €	F1	55	1
NR2-150-120	250,40 €	F1	55	1
NR2-150-150	250,40 €	F1	55	1
NR2-200-125	288,00 €	F1	55	1
NR2-200-160	288,00 €	F1	55	1
NR2-200-200	288,00 €	F1	55	1
NR2-25-0,25	33,45 €	F1	54	1/100
NR2-25-0,4	33,45 €	F1	54	1/100
NR2-25-0,63	33,45 €	F1	54	1/100
NR2-25-1	33,45 €	F1	54	1/100
NR2-25-1,6	33,45 €	F1	54	1/100
NR2-25-10	33,45 €	F1	54	1/100
NR2-25-13	33,45 €	F1	54	1/100
NR2-25-18	33,45 €	F1	54	1/100
NR2-25-2	33,45 €	F1	54	1/100
NR2-25-2,5	33,45 €	F1	54	1/100
NR2-25-25	33,45 €	F1	54	1/100
NR2-25-4	33,45 €	F1	54	1/100
NR2-25-6	33,45 €	F1	54	1/100
NR2-25-8	33,45 €	F1	54	1/100
NR2-36-32	40,40 €	F1	54	1
NR2-36-36	40,40 €	F1	54	1
NR2-630-250	304,20 €	F1	55	1
NR2-630-315	304,20 €	F1	55	1
NR2-630-400	304,20 €	F1	55	1
NR2-630-500	304,20 €	F1	55	1

Referencia	P.V.P.	Fam.	Pag.	Emb.
NR2-630-630	304,20 €	F1	55	1
NR2-93-32	72,20 €	F1	54	1
NR2-93-40	72,20 €	F1	54	1
NR2-93-50	72,20 €	F1	54	1
NR2-93-65	72,20 €	F1	54	1
NR2-93-70	72,20 €	F1	54	1
NR2-93-80	72,20 €	F1	54	1
NR2-93-93	72,20 €	F1	54	1
NRE8-100-100	90,30 €	F1	55	1
NRE8-100-65	82,40 €	F1	55	1
NRE8-200-120	313,00 €	F1	55	1
NRE8-200-160	315,30 €	F1	55	1
NRE8-200-200	330,00 €	F1	55	1
NRE8-25-1,2	41,80 €	F1	55	1
NRE8-25-10	41,80 €	F1	55	1
NRE8-25-12	41,80 €	F1	55	1
NRE8-25-2,4	41,80 €	F1	55	1
NRE8-25-20	41,80 €	F1	55	1
NRE8-25-25	50,50 €	F1	55	1
NRE8-25-32	50,50 €	F1	55	1
NRE8-25-4	41,80 €	F1	55	1
NRE8-25-8	41,80 €	F1	55	1
NRE8-40-10	52,80 €	F1	55	1
NRE8-40-20	52,80 €	F1	55	1
NRE8-40-4	52,80 €	F1	55	1
NRE8-40-40	52,80 €	F1	55	1
NRE8-40-8	52,80 €	F1	55	1
NRE8-630-250	340,20 €	F1	55	1
NRE8-630-315	343,30 €	F1	55	1
NRE8-630-400	354,80 €	F1	55	1
NRE8-630-500	375,60 €	F1	55	1
NRE8-630-630	380,70 €	F1	55	1
NS2-25-0,16	45,90 €	F1	56	1
NS2-25-0,25	45,90 €	F1	56	1
NS2-25-0,4	45,90 €	F1	56	1
NS2-25-0,63	45,90 €	F1	56	1
NS2-25-1	45,90 €	F1	56	1
NS2-25-1,6	45,90 €	F1	56	1
NS2-25-10	45,90 €	F1	56	1
NS2-25-14	45,90 €	F1	56	1
NS2-25-18	48,10 €	F1	56	1
NS2-25-2,5	45,90 €	F1	56	1
NS2-25-23	51,00 €	F1	56	1
NS2-25-25	53,50 €	F1	56	1
NS2-25-4	45,90 €	F1	56	1
NS2-25-6,3	45,90 €	F1	56	1
NS2-80B-25	103,20 €	F1	56	1
NS2-80B-40	112,60 €	F1	56	1
NS2-80B-63	142,50 €	F1	56	1
NS2-80B-80	147,20 €	F1	56	1
NS2-AE11	5,80 €	F1	56	1
NS2-AE20	5,80 €	F1	56	1
NS2-AU11	11,60 €	F1	56	1
NS2-AU11/80	11,60 €	F1	56	1
NS2-AU20	11,60 €	F1	56	1
NS2-AU20/80	11,60 €	F1	56	1
NS2-BOX-MC	22,40 €	F1	56	1
NS2-BOX-PE	31,10 €	F1	56	1
NS2-FA0101	10,40 €	F1	56	1
NS2-FA0110	10,40 €	F1	56	1
NS2-FA1001	10,40 €	F1	56	1
NS2-FA1010	10,40 €	F1	56	1
NS2-SH-110	27,20 €	F1	56	1
NS2-SH-230	27,20 €	F1	56	1
NS2-SH-400	27,20 €	F1	56	1
NS2-SH-440	27,20 €	F1	56	1
NS2-UV-110	27,20 €	F1	56	1
NS2-UV-230	27,20 €	F1	56	1
NS2-UV-400	27,20 €	F1	56	1
NS2-UV-440	27,20 €	F1	56	1

Referencia	P.V.P.	Fam.	Pag.	Emb.
NTE8-10A/230	29,50 €	F1	22	12/120
NTE8-10B/230	29,50 €	F1	22	12/120
NTE8-10B/24CA	29,50 €	F1	22	12/120
NTE8-10B/24CC	29,50 €	F1	22	12/120
NTE8-120A/230	29,50 €	F1	22	12/120
NTE8-120B/230	29,50 €	F1	22	12/120
NTE8-120B/24CA	29,50 €	F1	22	12/120
NTE8-120B/24CC	29,50 €	F1	22	12/120
NTE8-480A/230	29,50 €	F1	22	12/120
NTE8-480B/230	29,50 €	F1	22	12/120
NTE8-480B/24CA	29,50 €	F1	22	12/120
NTE8-480B/24CC	29,50 €	F1	22	12/120
NU6-I/40/400	134,10 €	F4	12	10/180
NU6-II/2/15/385	81,30 €	F4	12	6/90
NU6-II/2/25/385	91,30 €	F4	12	6/90
NU6-II/2/40/385	96,30 €	F4	12	4/45
NU6-II/4/15/460	146,30 €	F4	12	3/45
NU6-II/4/25/460	158,30 €	F4	12	3/45
NU6-II/4/25/510	158,30 €	F4	12	3/45
NU6-II/4/25/550	158,30 €	F4	12	3/45
NU6-II/4/40/460	167,30 €	F4	12	2/15
NU6-III/10/385E	82,50 €	F4	12	12/180
NU9-PR230	96,30 €	F4	11	1
NU9-PR400	293,50 €	F4	11	1
NWC5-0.4-10-3	75,00 €	F4	85	1
NWC5-0.4-12-3	88,00 €	F4	85	1
NWC5-0.4-14-3	99,00 €	F4	85	1
NWC5-0.4-15-3	103,00 €	F4	85	1
NWC5-0.4-16-3	109,00 €	F4	85	1
NWC5-0.4-18-3	114,00 €	F4	85	1
NWC5-0.4-20-3	120,00 €	F4	85	1
NWC5-0.4-25-3	133,00 €	F4	85	1
NWC5-0.45-10-3	78,00 €	F4	85	1
NWC5-0.45-12-3	98,00 €	F4	85	1
NWC5-0.45-14-3	107,00 €	F4	85	1
NWC5-0.45-15-3	115,00 €	F4	85	1
NWC5-0.45-16-3	121,00 €	F4	85	1
NWC5-0.45-18-3	125,00 €	F4	85	1
NWC5-0.45-20-3	131,00 €	F4	85	1
NWC5-0.45-25-3	144,00 €	F4	85	1
NWC5-0.525-10-3	80,00 €	F4	85	1
NWC5-0.525-12-3	100,00 €	F4	85	1
NWC5-0.525-14-3	110,00 €	F4	85	1
NWC5-0.525-15-3	119,00 €	F4	85	1
NWC5-0.525-16-3	125,00 €	F4	85	1
NWC5-0.525-18-3	131,00 €	F4	85	1
NWC5-0.525-20-3	148,00 €	F4	85	1
NWC5-0.525-25-3	159,00 €	F4	85	1
NX8-12	21,50 €	F3	28	1
NX8-15	29,20 €	F3	28	1
NX8-20	32,40 €	F3	28	1
NX8-24	33,30 €	F3	28	1
NX8-5	13,60 €	F3	28	1
NX8-8	18,10 €	F3	28	1
NXW1-3	23,60 €	F3	28	1
NXW1-5	29,30 €	F3	28	1
NZK1-1-32	11,50 €	F1	22	12/120
NZK1-2-32	22,90 €	F1	22	12/120
NZK1-3-32	30,10 €	F1	22	12/120
NZK2-1-32	10,85 €	F1	22	12/120
NZK2-2-32	20,45 €	F1	22	12/120
NZK2-3-32	29,10 €	F1	22	12/120
OMA-24	25,20 €	F5	118	1
OMA-32	29,70 €	F5	118	1
OMA-36	34,90 €	F5	118	1
OMA-42	41,10 €	F5	118	1
PD-AL	10,90 €	F5	118	1
PD-N	5,30 €	F5	118	1
PD-R	8,70 €	F5	118	1
PP	14,80 €	F5	124	1

Referencia	P.V.P.	Fam.	Pag.	Emb.
PSP230V	96,30 €	F4	11	12/120
PSP230V	96,30 €	F4	11	12/120
PSP230V	96,30 €	F4	11	12/120
PSP230V	96,30 €	F4	11	12/120
PSP230V	96,30 €	F4	11	12/120
PSP230V	96,30 €	F4	11	12/120
PSP230V	96,30 €	F4	11	12/120
PSP230V	96,30 €	F4	11	12/120
PSP230V	96,30 €	F4	11	12/120
PSP230V	96,30 €	F4	11	12/120
PSP230V	96,30 €	F4	11	12/120
PSP230V	96,30 €	F4	11	12/120
PSP230V	96,30 €	F4	11	12/120
PSP230V	96,30 €	F4	11	12/120
PSP230V	96,30 €	F4	11	12/120
PSP400V	283,50 €	F4	11	4/40
PSP400V	283,50 €	F4	11	4/40
PSP400V	283,50 €	F4	11	4/40
PSP400V	283,50 €	F4	11	4/40
PSP400V	283,50 €	F4	11	4/40
PSP400V	283,50 €	F4	11	4/40
PSP400V	283,50 €	F4	11	4/40
PSP400V	283,50 €	F4	11	4/40
PSP400V	283,50 €	F4	11	4/40
PSP400V	283,50 €	F4	11	4/40
PV- 12	67,70 €	F5	118	1
PV- 14	69,90 €	F5	118	1
PV- 16	74,30 €	F5	118	1
PV- 18	78,80 €	F5	118	1
PV- 20	83,50 €	F5	118	1
QJX2- 10/14- 110	197,50 €	F2	59	1
QJX2- 10/14- 230	197,50 €	F2	59	1
QJX2- 10/14- 24	197,50 €	F2	59	1
QJX2- 10/14- 400	197,50 €	F2	59	1
QJX2- 10/14- 48	197,50 €	F2	59	1
QJX2- 110/150- 110	963,00 €	F2	59	1
QJX2- 110/150- 230	963,00 €	F2	59	1
QJX2- 110/150- 400	963,00 €	F2	59	1
QJX2- 132/180- 110	1.112,50 €	F2	59	1
QJX2- 132/180- 230	1.112,50 €	F2	59	1
QJX2- 132/180- 400	1.112,50 €	F2	59	1
QJX2- 15/20- 110	237,70 €	F2	59	1
QJX2- 15/20- 230	237,70 €	F2	59	1
QJX2- 15/20- 24	237,70 €	F2	59	1
QJX2- 15/20- 400	237,70 €	F2	59	1
QJX2- 15/20- 48	237,70 €	F2	59	1
QJX2- 160/217- 110	1.434,50 €	F2	59	1
QJX2- 160/217- 230	1.434,50 €	F2	59	1
QJX2- 160/217- 400	1.434,50 €	F2	59	1
QJX2- 18,5/25- 110	240,60 €	F2	59	1
QJX2- 18,5/25- 230	240,60 €	F2	59	1
QJX2- 18,5/25- 24	240,60 €	F2	59	1
QJX2- 18,5/25- 400	240,60 €	F2	59	1
QJX2- 18,5/25- 48	240,60 €	F2	59	1
QJX2- 185/251- 110	1.664,50 €	F2	59	1
QJX2- 185/251- 230	1.664,50 €	F2	59	1
QJX2- 185/251- 400	1.664,50 €	F2	59	1
QJX2- 220/299- 110	1.742,70 €	F2	59	1
QJX2- 220/299- 230	1.742,70 €	F2	59	1
QJX2- 220/299- 400	1.742,70 €	F2	59	1
QJX2- 25/34- 110	324,60 €	F2	59	1
QJX2- 25/34- 230	324,60 €	F2	59	1
QJX2- 25/34- 24	324,60 €	F2	59	1
QJX2- 25/34- 400	324,60 €	F2	59	1
QJX2- 25/34- 48	324,60 €	F2	59	1
QJX2- 280/380- 110	2.308,50 €	F2	59	1
QJX2- 280/380- 230	2.308,50 €	F2	59	1
QJX2- 280/380- 400	2.308,50 €	F2	59	1

Referencia	P.V.P.	Fam.	Pag.	Emb.
QJX2- 315/428- 110	2.676,50 €	F2	59	1
QJX2- 315/428- 230	2.676,50 €	F2	59	1
QJX2- 315/428- 400	2.676,50 €	F2	59	1
QJX2- 33/45- 110	327,80 €	F2	59	1
QJX2- 33/45- 230	327,80 €	F2	59	1
QJX2- 33/45- 24	327,80 €	F2	59	1
QJX2- 33/45- 400	327,80 €	F2	59	1
QJX2- 33/45- 48	327,80 €	F2	59	1
QJX2- 45/60- 110	440,00 €	F2	59	1
QJX2- 45/60- 230	440,00 €	F2	59	1
QJX2- 45/60- 24	440,00 €	F2	59	1
QJX2- 45/60- 400	440,00 €	F2	59	1
QJX2- 45/60- 48	440,00 €	F2	59	1
QJX2- 450/611- 110	3.217,00 €	F2	59	1
QJX2- 450/611- 230	3.217,00 €	F2	59	1
QJX2- 450/611- 400	3.217,00 €	F2	59	1
QJX2- 55/75- 110	571,90 €	F2	59	1
QJX2- 55/75- 230	571,90 €	F2	59	1
QJX2- 55/75- 24	571,90 €	F2	59	1
QJX2- 55/75- 400	571,90 €	F2	59	1
QJX2- 55/75- 48	571,90 €	F2	59	1
QJX2- 63/85- 110	584,80 €	F2	59	1
QJX2- 63/85- 230	584,80 €	F2	59	1
QJX2- 63/85- 24	584,80 €	F2	59	1
QJX2- 63/85- 400	584,80 €	F2	59	1
QJX2- 63/85- 48	584,80 €	F2	59	1
QJX2- 630/856- 110	3.631,00 €	F2	59	1
QJX2- 630/856- 230	3.631,00 €	F2	59	1
QJX2- 630/856- 400	3.631,00 €	F2	59	1
QJX2- 7,5/10- 110	181,90 €	F2	59	1
QJX2- 7,5/10- 230	181,90 €	F2	59	1
QJX2- 7,5/10- 24	181,90 €	F2	59	1
QJX2- 7,5/10- 400	181,90 €	F2	59	1
QJX2- 7,5/10- 48	181,90 €	F2	59	1
QJX2- 80/110- 110	813,70 €	F2	59	1
QJX2- 80/110- 230	813,70 €	F2	59	1
QJX2- 80/110- 24	813,70 €	F2	59	1
QJX2- 80/110- 400	813,70 €	F2	59	1
QJX2- 80/110- 48	813,70 €	F2	59	1
RDC- 01/230	183,50 €	F5	47	1
RDC- 01/24	183,50 €	F5	47	1
RDC- 02/230	198,50 €	F5	47	1
RDC- 02/24	198,50 €	F5	47	1
RDC- 03- 230	257,80 €	F5	47	1
RDC- 04- 230	257,80 €	F5	47	1
RDC21/110	224,50 €	F5	47	1
RDC21/110	224,50 €	F5	47	1
RDC- 21/35- 230	183,50 €	F5	47	1
RDC- 21/35- 24	183,50 €	F5	47	1
RDC- 21/60- 230	196,50 €	F5	47	1
RDC- 21/60- 24	196,50 €	F5	47	1
RDC- 31	233,50 €	F5	48	1
RDC- 38	303,50 €	F5	48	1
RMC- 31	238,50 €	F5	48	1
RMC- 32	298,50 €	F5	48	1
RT28- 32/aM/10	0,67 €	F2	79	50
RT28- 32/aM/10/1F	0,72 €	F2	79	50
RT28- 32/aM/16	0,67 €	F2	79	50
RT28- 32/aM/16/1F	0,72 €	F2	79	50
RT28- 32/aM/2	0,67 €	F2	79	50
RT28- 32/aM/2/1F	0,72 €	F2	79	50
RT28- 32/aM/20	0,67 €	F2	79	50
RT28- 32/aM/20/1F	0,72 €	F2	79	50
RT28- 32/aM/25	0,67 €	F2	79	50
RT28- 32/aM/25/1F	0,72 €	F2	79	50
RT28- 32/aM/32	0,67 €	F2	79	50
RT28- 32/aM/32/1F	0,72 €	F2	79	50
RT28- 32/aM/4	0,67 €	F2	79	50
RT28- 32/aM/4/1F	0,72 €	F2	79	50
RT28- 32/aM/6	0,67 €	F2	79	50

Referencia	P.V.P.	Fam.	Pag.	Emb.
RT28-32/aM/6/1F	0,72 €	F2	79	50
RT28-32/aM/8	0,67 €	F2	79	50
RT28-32/aM/8/1F	0,72 €	F2	79	50
RT28-32/gG//16/F	0,72 €	F2	79	50
RT28-32/gG/10	0,67 €	F2	79	50
RT28-32/gG/10/F	0,72 €	F2	79	50
RT28-32/gG/16	0,67 €	F2	79	50
RT28-32/gG/2	0,67 €	F2	79	50
RT28-32/gG/2/F	0,72 €	F2	79	50
RT28-32/gG/20	0,67 €	F2	79	50
RT28-32/gG/20/F	0,72 €	F2	79	50
RT28-32/gG/25	0,67 €	F2	79	50
RT28-32/gG/25/F	0,72 €	F2	79	50
RT28-32/gG/32	0,67 €	F2	79	50
RT28-32/gG/32/F	0,72 €	F2	79	50
RT28-32/gG/4	0,67 €	F2	79	50
RT28-32/gG/4/F	0,72 €	F2	79	50
RT28-32/gG/6	0,67 €	F2	79	50
RT28-32/gG/6/F	0,72 €	F2	79	50
RT28-32/gG/8	0,67 €	F2	79	50
RT28-32/gG/8/F	0,72 €	F2	79	50
RT28-63/aM/10	0,97 €	F2	79	50
RT28-63/aM/10/1F	1,10 €	F2	79	50
RT28-63/aM/16	0,97 €	F2	79	50
RT28-63/aM/16/1F	1,10 €	F2	79	50
RT28-63/aM/20	0,97 €	F2	79	50
RT28-63/aM/20/1F	1,10 €	F2	79	50
RT28-63/aM/25	0,97 €	F2	79	50
RT28-63/aM/25/1F	1,10 €	F2	79	50
RT28-63/aM/32	0,97 €	F2	79	50
RT28-63/aM/32/1F	1,10 €	F2	79	50
RT28-63/aM/40	0,97 €	F2	79	50
RT28-63/aM/40/1F	1,10 €	F2	79	50
RT28-63/aM/50	0,97 €	F2	79	50
RT28-63/aM/50/1F	1,10 €	F2	79	50
RT28-63/aM/63	0,97 €	F2	79	50
RT28-63/aM/63/1F	1,10 €	F2	79	50
RT28-63/gG/10	0,97 €	F2	79	50
RT28-63/gG/10/1F	1,10 €	F2	79	50
RT28-63/gG/16	0,97 €	F2	79	50
RT28-63/gG/16/1F	1,10 €	F2	79	50
RT28-63/gG/20	0,97 €	F2	79	50
RT28-63/gG/20/1F	1,10 €	F2	79	50
RT28-63/gG/25	0,97 €	F2	79	50
RT28-63/gG/25/1F	1,10 €	F2	79	50
RT28-63/gG/32	0,97 €	F2	79	50
RT28-63/gG/32/1F	1,10 €	F2	79	50
RT28-63/gG/40	0,97 €	F2	79	50
RT28-63/gG/40/1F	1,10 €	F2	79	50
RT28-63/gG/50	0,97 €	F2	79	50
RT28-63/gG/50/1F	1,10 €	F2	79	50
RT28-63/gG/63	0,97 €	F2	79	50
RT28-63/gG/63/1F	1,10 €	F2	79	50
RT29-125/aM/100	2,50 €	F2	79	50
RT29-125/aM/125	2,50 €	F2	79	50
RT29-125/aM/25	2,50 €	F2	79	50
RT29-125/aM/32	2,50 €	F2	79	50
RT29-125/aM/40	2,50 €	F2	79	50
RT29-125/aM/50	2,50 €	F2	79	50
RT29-125/aM/63	2,50 €	F2	79	50
RT29-125/aM/80	2,50 €	F2	79	50
RT29-125/gG/100	2,50 €	F2	79	50
RT29-125/gG/125	2,50 €	F2	79	50
RT29-125/gG/25	2,50 €	F2	79	50
RT29-125/gG/32	2,50 €	F2	79	50
RT29-125/gG/40	2,50 €	F2	79	50
RT29-125/gG/50	2,50 €	F2	79	50
RT29-125/gG/63	2,50 €	F2	79	50
RT29-125/gG/80	2,50 €	F2	79	50
RT29-16/aM/10	0,52 €	F2	79	50

Referencia	P.V.P.	Fam.	Pag.	Emb.
RT29-16/aM/16	0,52 €	F2	79	50
RT29-16/aM/2	0,52 €	F2	79	50
RT29-16/aM/4	0,52 €	F2	79	50
RT29-16/aM/6	0,52 €	F2	79	50
RT29-16/aM/8	0,52 €	F2	79	50
RT29-16/gG/10	0,52 €	F2	79	50
RT29-16/gG/16	0,52 €	F2	79	50
RT29-16/gG/2	0,52 €	F2	79	50
RT29-16/gG/4	0,52 €	F2	79	50
RT29-16/gG/6	0,52 €	F2	79	50
RT29-16/gG/8	0,52 €	F2	79	50
RT36-0/aM/10	6,55 €	F2	80	3
RT36-0/aM/100	6,75 €	F2	80	3
RT36-0/aM/125	6,75 €	F2	80	3
RT36-0/aM/16	6,55 €	F2	80	3
RT36-0/aM/160	6,75 €	F2	80	3
RT36-0/aM/20	6,55 €	F2	80	3
RT36-0/aM/25	6,55 €	F2	80	3
RT36-0/aM/32	6,55 €	F2	80	3
RT36-0/aM/4	6,55 €	F2	80	3
RT36-0/aM/40	6,55 €	F2	80	3
RT36-0/aM/50	6,55 €	F2	80	3
RT36-0/aM/6	6,55 €	F2	80	3
RT36-0/aM/63	6,55 €	F2	80	3
RT36-0/aM/80	6,55 €	F2	80	3
RT36-0/gG/10	6,55 €	F2	80	3
RT36-0/gG/100	6,75 €	F2	80	3
RT36-0/gG/125	6,75 €	F2	80	3
RT36-0/gG/16	6,55 €	F2	80	3
RT36-0/gG/160	6,75 €	F2	80	3
RT36-0/gG/20	6,55 €	F2	80	3
RT36-0/gG/25	6,55 €	F2	80	3
RT36-0/gG/32	6,55 €	F2	80	3
RT36-0/gG/4	6,55 €	F2	80	3
RT36-0/gG/40	6,55 €	F2	80	3
RT36-0/gG/50	6,55 €	F2	80	3
RT36-0/gG/6	6,55 €	F2	80	3
RT36-0/gG/63	6,55 €	F2	80	3
RT36-0/gG/80	6,55 €	F2	80	3
RT36-00/aM/10	6,25 €	F2	80	3
RT36-00/aM/100	6,25 €	F2	80	3
RT36-00/aM/125	6,44 €	F2	80	3
RT36-00/aM/16	6,25 €	F2	80	3
RT36-00/aM/160	6,44 €	F2	80	3
RT36-00/aM/20	6,25 €	F2	80	3
RT36-00/aM/25	6,25 €	F2	80	3
RT36-00/aM/32	6,25 €	F2	80	3
RT36-00/aM/4	6,25 €	F2	80	3
RT36-00/aM/40	6,25 €	F2	80	3
RT36-00/aM/50	6,25 €	F2	80	3
RT36-00/aM/6	6,25 €	F2	80	3
RT36-00/aM/63	6,25 €	F2	80	3
RT36-00/aM/80	6,25 €	F2	80	3
RT36-00/gG/10	6,25 €	F2	80	3
RT36-00/gG/100	6,25 €	F2	80	3
RT36-00/gG/125	6,44 €	F2	80	3
RT36-00/gG/16	6,25 €	F2	80	3
RT36-00/gG/160	6,44 €	F2	80	3
RT36-00/gG/20	6,25 €	F2	80	3
RT36-00/gG/25	6,25 €	F2	80	3
RT36-00/gG/32	6,25 €	F2	80	3
RT36-00/gG/4	6,25 €	F2	80	3
RT36-00/gG/40	6,25 €	F2	80	3
RT36-00/gG/50	6,25 €	F2	80	3
RT36-00/gG/6	6,25 €	F2	80	3
RT36-00/gG/63	6,25 €	F2	80	3
RT36-00/gG/80	6,25 €	F2	80	3
RT36-1/aM/100	10,10 €	F2	80	3
RT36-1/aM/125	10,10 €	F2	80	3
RT36-1/aM/160	11,50 €	F2	80	3

Referencia	P.V.P.	Fam.	Pag.	Emb.
RT36- 1/aM/200	11,50 €	F2	80	3
RT36- 1/aM/250	11,50 €	F2	80	3
RT36- 1/aM/80	10,10 €	F2	80	3
RT36- 1/gG/100	10,10 €	F2	80	3
RT36- 1/gG/125	10,10 €	F2	80	3
RT36- 1/gG/160	11,50 €	F2	80	3
RT36- 1/gG/200	11,50 €	F2	80	3
RT36- 1/gG/250	11,50 €	F2	80	3
RT36- 1/gG/80	10,10 €	F2	80	3
RT36- 2/aM/125	13,90 €	F2	80	1
RT36- 2/aM/160	13,90 €	F2	80	1
RT36- 2/aM/200	13,90 €	F2	80	1
RT36- 2/aM/250	13,90 €	F2	80	1
RT36- 2/aM/300	15,15 €	F2	80	1
RT36- 2/aM/315	15,15 €	F2	80	1
RT36- 2/aM/355	15,15 €	F2	80	1
RT36- 2/aM/400	15,15 €	F2	80	1
RT36- 2/gG/125	13,90 €	F2	80	1
RT36- 2/gG/160	13,90 €	F2	80	1
RT36- 2/gG/200	13,90 €	F2	80	1
RT36- 2/gG/250	13,90 €	F2	80	1
RT36- 2/gG/300	15,15 €	F2	80	1
RT36- 2/gG/315	15,15 €	F2	80	1
RT36- 2/gG/355	15,15 €	F2	80	1
RT36- 2/gG/400	15,15 €	F2	80	1
RT36- 3/aM/315	22,25 €	F2	80	1
RT36- 3/aM/355	22,25 €	F2	80	1
RT36- 3/aM/400	22,25 €	F2	80	1
RT36- 3/aM/500	23,60 €	F2	80	1
RT36- 3/aM/630	25,40 €	F2	80	1
RT36- 3/gG/315	22,25 €	F2	80	1
RT36- 3/gG/355	22,25 €	F2	80	1
RT36- 3/gG/400	22,25 €	F2	80	1
RT36- 3/gG/500	23,60 €	F2	80	1
RT36- 3/gG/630	25,40 €	F2	80	1
RT36- 4/aM/1000	116,70 €	F2	80	1
RT36- 4/aM/800	104,90 €	F2	80	1
RT36- 4/gG/1000	116,70 €	F2	80	1
RT36- 4/gG/800	104,90 €	F2	80	1
RW666/CARD	50,00 €	F5	99	1
RW666/LC	530,00 €	F5	99	1
RW666/SOFT	220,00 €	F5	99	1
S9- 230VCA	36,05 €	F4	11	1/10
S9- 24VCC	36,05 €	F4	11	1/10
S9- 48VCC	36,05 €	F4	11	1/10
SC3L	44,70 €	F3	28	1
SR2- A- 230	10,80 €	F2	53	1
SR2- A- 24	10,80 €	F2	53	1
SR2- A- 400	10,80 €	F2	53	1
SR2- B- 230	14,30 €	F2	53	1
SR2- B- 24	14,30 €	F2	53	1
SR2- B- 400	14,30 €	F2	53	1
TCE	91,80 €	F5	118	1
TCL	108,30 €	F5	118	1
TCN/E	48,10 €	F5	118	1
TCN/EL	62,50 €	F5	118	1
TC- S	11,20 €	F3	27	6
TTC- 028D	47,30 €	F5	47	1
TTC- 035C	62,30 €	F5	47	1
TTC- 060C	71,80 €	F5	47	1
TTC- 080C	98,60 €	F5	47	1
TTC- 110A	248,50 €	F5	47	1
TTC- 110C	133,30 €	F5	47	1
TTC- 160A	378,00 €	F5	47	1
TTC- 160C	344,10 €	F5	47	1
TTC- 210A	404,70 €	F5	47	1
TTC- 210C	378,40 €	F5	47	1
UB- 1- 10C	9,80 €	F1	2	12/120
UB- 1- 16C	9,80 €	F1	2	12/120
UB- 1- 20C	9,80 €	F1	2	12/120

Referencia	P.V.P.	Fam.	Pag.	Emb.
UB- 1- 25C	9,80 €	F1	2	12/120
UB- 1- 32C	10,10 €	F1	2	12/120
UB- 1- 40C	11,80 €	F1	2	12/120
UB- 1- 6C	9,80 €	F1	2	12/120
UB- 2- 10C	21,60 €	F1	2	6/60
UB- 2- 16C	21,60 €	F1	2	6/60
UB- 2- 20C	21,60 €	F1	2	6/60
UB- 2- 25C	21,60 €	F1	2	6/60
UB- 2- 32C	23,90 €	F1	2	6/60
UB- 2- 40C	28,00 €	F1	2	6/60
UB- 2- 6C	21,60 €	F1	2	6/60
UB- 3- 10C	34,20 €	F1	2	4/40
UB- 3- 16C	34,20 €	F1	2	4/40
UB- 3- 20C	34,20 €	F1	2	4/40
UB- 3- 25C	34,20 €	F1	2	4/40
UB- 3- 32C	37,20 €	F1	2	4/40
UB- 3- 40C	46,10 €	F1	2	4/40
UB- 3- 6C	34,20 €	F1	2	4/40
UB- 4- 10C	45,40 €	F1	2	3/30
UB- 4- 16C	45,40 €	F1	2	3/30
UB- 4- 20C	45,40 €	F1	2	3/30
UB- 4- 25C	45,40 €	F1	2	3/30
UB- 4- 32C	48,50 €	F1	2	3/30
UB- 4- 40C	63,40 €	F1	2	3/30
UB- 4- 6C	45,40 €	F1	2	3/30
V9- 230VCA	36,05 €	F4	11	1/10
V9- 24VCA	36,05 €	F4	11	1/10
WS18- 1/125	12,40 €	F2	79	6
WS18- 1/32	3,70 €	F2	79	12
WS18- 1/63	6,40 €	F2	79	12
WS18- 2/125	18,90 €	F2	79	4
WS18- 2/32	5,60 €	F2	79	6
WS18- 2/63	9,90 €	F2	79	6
WS18- 3/125	28,00 €	F2	79	2
WS18- 3/32	9,00 €	F2	79	4
WS18- 3/63	15,00 €	F2	79	4
XF9	26,10 €	F4	11	1/10
XF9J	26,20 €	F4	11	1/10
YBLT- EKW/SA/B	45,10 €	F2	100	1
YBLX- 19/001	28,90 €	F2	100	1
YBLX- 19/111	28,90 €	F2	100	1
YBLX- 19/121	28,90 €	F2	100	1
YBLX- 19/131	28,90 €	F2	100	1
YBLX- 19/212	28,90 €	F2	100	1
YBLX- 19/222	28,90 €	F2	100	1
YBLX- 19/232	28,90 €	F2	100	1
YBLX- 19/K	28,90 €	F2	100	1
YBLX- 2	26,40 €	F2	100	1
YBLX- 2/N	26,40 €	F2	100	1
YBLX- 5/11	14,20 €	F2	100	1
YBLX- 5/11D	14,20 €	F2	100	1
YBLX- 5/11H	14,20 €	F2	100	1
YBLX- 5/11N	14,20 €	F2	100	1
YBLX- 5/11N1	14,20 €	F2	100	1
YBLX- 5/11N2	14,20 €	F2	100	1
YBLX- 5/11Q1	14,20 €	F2	100	1
YBLX- CK/J10511	40,60 €	F2	100	1
YBLX- CK/J10541	40,60 €	F2	100	1
YBLX- CK/J167	40,60 €	F2	100	1
YBLX- CK/M102	40,60 €	F2	100	1
YBLX- CK/M106	40,60 €	F2	100	1
YBLX- CK/M110	40,60 €	F2	100	1
YBLX- CK/M115	40,60 €	F2	100	1
YBLX- CK/M121	40,60 €	F2	100	1
YBLX- CK/P102	40,60 €	F2	100	1
YBLX- CK/P106	40,60 €	F2	100	1
YBLX- CK/P110	40,60 €	F2	100	1
YBLX- CK/P121	40,60 €	F2	100	1
YBLX- CK/S102	40,60 €	F2	100	1
YBLX- CK/T110	40,60 €	F2	100	1

Referencia	P.V.P.	Fam.	Pag.	Emb.
YBLX-CK/T121	40,60 €	F2	100	1
YBLX-HL/5000	40,60 €	F2	100	1
YBLX-HL/5030	40,60 €	F2	100	1
YBLX-HL/5050	40,60 €	F2	100	1
YBLX-HL/5100	40,60 €	F2	100	1
YBLX-HL/5200	40,60 €	F2	100	1
YBLX-HL/5300	40,60 €	F2	100	1
YBLX-HL/5500	40,60 €	F2	100	1
YBLX-K1-111	20,90 €	F2	100	1
YBLX-K1-211	20,90 €	F2	100	1
YBLX-K1-311	20,90 €	F2	100	1
YBLX-K1-411	20,90 €	F2	100	1
YBLX-K1-511	20,90 €	F2	100	1
YBLX-K1-611	20,90 €	F2	100	1
YBLX-K1-711	20,90 €	F2	100	1
YBLX-K2/001	21,80 €	F2	100	1
YBLX-K2/101	21,80 €	F2	100	1
YBLX-K2/111	21,80 €	F2	100	1
YBLX-K2/211	21,80 €	F2	100	1
YBLX-K2/311	21,80 €	F2	100	1
YBLX-K2/411	21,80 €	F2	100	1
YBLX-K2/411K	21,80 €	F2	100	1
YBLX-K3/20H/D	22,00 €	F2	100	1
YBLX-K3/20S/B	22,00 €	F2	100	1
YBLX-K3/20S/H1	22,00 €	F2	100	1
YBLX-K3/20S/H2	22,00 €	F2	100	1
YBLX-K3/20S/H3	22,00 €	F2	100	1
YBLX-K3/20S/T	22,00 €	F2	100	1
YBLX-K3/20S/W	22,00 €	F2	100	1
YBLX-K3/20S/Z	22,00 €	F2	100	1
YBLX-KLT2/II	126,30 €	F2	100	1
YBLX-ME/8101	34,50 €	F2	100	1
YBLX-ME/8104	34,50 €	F2	100	1
YBLX-ME/8107	34,50 €	F2	100	1
YBLX-ME/8108	34,50 €	F2	100	1
YBLX-ME/8111	34,50 €	F2	100	1
YBLX-ME/8112	34,50 €	F2	100	1
YBLX-ME/8122Y	34,50 €	F2	100	1
YBLX-ME/8166	34,50 €	F2	100	1
YBLX-ME/8169	34,50 €	F2	100	1
YBLX-P1/100/1B	31,10 €	F2	100	1
YBLX-P1/100/1C	31,10 €	F2	100	1
YBLX-P1/100/1D	31,10 €	F2	100	1
YBLX-P1/100/1E	31,10 €	F2	100	1
YBLX-P1/100/1F	31,10 €	F2	100	1
YBLX-P1/100/1G	31,10 €	F2	100	1
YBLX-P1/100/1P	31,10 €	F2	100	1
YBLX-P1/100/1R	31,10 €	F2	100	1
YBLX-P1/100/1T	31,10 €	F2	100	1
YBLX-P1/100/1U	31,10 €	F2	100	1
YBLX-P1/120/1B	31,10 €	F2	100	1
YBLX-P1/120/1C	31,10 €	F2	100	1
YBLX-P1/120/1D	31,10 €	F2	100	1
YBLX-P1/120/1E	31,10 €	F2	100	1
YBLX-P1/120/1F	31,10 €	F2	100	1
YBLX-P1/120/1G	31,10 €	F2	100	1
YBLX-P1/120/1P	31,10 €	F2	100	1
YBLX-P1/120/1R	31,10 €	F2	100	1
YBLX-P1/120/1T	31,10 €	F2	100	1
YBLX-P1/120/1U	31,10 €	F2	100	1
YBLX-P1/303/1B	31,10 €	F2	404	1
YBLX-P1/303/1C	31,10 €	F2	404	1
YBLX-P1/303/1D	31,10 €	F2	404	1
YBLX-P1/303/1E	31,10 €	F2	404	1
YBLX-P1/303/1F	31,10 €	F2	404	1
YBLX-P1/303/1G	31,10 €	F2	404	1
YBLX-P1/303/1P	31,10 €	F2	404	1
YBLX-P1/303/1R	31,10 €	F2	404	1
YBLX-P1/303/1T	31,10 €	F2	404	1
YBLX-P1/303/1U	31,10 €	F2	404	1
YBLX-P1/404/1B	31,10 €	F2	404	1

Referencia	P.V.P.	Fam.	Pag.	Emb.
YBLX-P1/404/1C	31,10 €	F2	404	1
YBLX-P1/404/1D	31,10 €	F2	404	1
YBLX-P1/404/1E	31,10 €	F2	404	1
YBLX-P1/404/1F	31,10 €	F2	404	1
YBLX-P1/404/1G	31,10 €	F2	404	1
YBLX-P1/404/1P	31,10 €	F2	404	1
YBLX-P1/404/1R	31,10 €	F2	404	1
YBLX-P1/404/1T	31,10 €	F2	404	1
YBLX-P1/404/1U	31,10 €	F2	404	1
YBLXW-5/11D1	14,20 €	F2	100	1
YBLXW-5/11D1/L	14,20 €	F2	100	1
YBLXW-5/11G1	14,20 €	F2	100	1
YBLXW-5/11G1/L	14,20 €	F2	100	1
YBLXW-5/11G2	14,20 €	F2	100	1
YBLXW-5/11G2/L	14,20 €	F2	100	1
YBLXW-5/11G2277	14,20 €	F2	100	1
YBLXW-5/11G3	14,20 €	F2	100	1
YBLXW-5/11G3/L	14,20 €	F2	100	1
YBLXW-5/11GS	14,20 €	F2	100	1
YBLXW-5/11M	14,20 €	F2	100	1
YBLXW-5/11M/L	14,20 €	F2	100	1
YBLXW-5/11N1	14,20 €	F2	100	1
YBLXW-5/11N1/L	14,20 €	F2	100	1
YBLXW-5/11N2	14,20 €	F2	100	1
YBLXW-5/11N2/L	14,20 €	F2	100	1
YBLXW-5/11Q1	14,20 €	F2	100	1
YBLXW-5/11Q1/L	14,20 €	F2	100	1
YBLXW-5/11Q2	14,20 €	F2	100	1
YBLXW-5/11Q2/L	14,20 €	F2	100	1
YBLXW-5/11Z	14,20 €	F2	100	1
YBLXW-5/11Z/L	14,20 €	F2	100	1
YBLXW-6/11	19,90 €	F2	100	1
YBLXW-6/11BZ	19,90 €	F2	100	1
YBLXW-6/11CA	19,90 €	F2	100	1
YBLXW-6/11CDL	19,90 €	F2	100	1
YBLXW-6/11CG	19,90 €	F2	100	1
YBLXW-6/11CL	19,90 €	F2	100	1
YBLXW-6/11DA	19,90 €	F2	100	1
YBLXW-6/11DA2	19,90 €	F2	100	1
YBLXW-6/11DDL	19,90 €	F2	100	1
YBLXW-6/11DG	19,90 €	F2	100	1
YBLXW-6/11DL	19,90 €	F2	100	1
YBLXW-6/11HL	19,90 €	F2	100	1
YBLXW-6/11W1	19,90 €	F2	100	1
YBLXW-6/11W2	19,90 €	F2	100	1
YBLXW-6/11W3	19,90 €	F2	100	1
YBLXW-6/11ZL	19,90 €	F2	100	1
YBLX-WL/CA12	41,50 €	F2	100	1
YBLX-WL/CA12/2N	41,50 €	F2	100	1
YBLX-WL/CA2	41,50 €	F2	100	1
YBLX-WL/CA2/2N	41,50 €	F2	100	1
YBLX-WL/CA2/31	41,50 €	F2	100	1
YBLX-WL/CA2/7	41,50 €	F2	100	1
YBLX-WL/CA2/8	41,50 €	F2	100	1
YBLX-WL/CA2/GCA2	41,50 €	F2	100	1
YBLX-WL/CA32/41/43	41,50 €	F2	100	1
YBLX-WL/CL	41,50 €	F2	100	1
YBLX-WL/CL/2N	41,50 €	F2	100	1
YBLX-WL/D	41,50 €	F2	100	1
YBLX-WL/D2	41,50 €	F2	100	1
YBLX-WL/D28	41,50 €	F2	100	1
YBLX-WL/D3	41,50 €	F2	100	1
YBLX-WL/HAL4	41,50 €	F2	100	1
YBLX-WL/HAL5	41,50 €	F2	100	1
YBLX-WL/NJ	41,50 €	F2	100	1
YBLX-WL/NJ/2	41,50 €	F2	100	1
YBLX-WL/NJ/S2	41,50 €	F2	100	1
YBLX-WL/NJ30	41,50 €	F2	100	1
YBLX-WL/SD	41,50 €	F2	100	1
YBLX-WL/SD2	41,50 €	F2	100	1
YBLX-WL/SD3	41,50 €	F2	100	1